



AUTOMATED CONTROL APPROACH FOR INDUSTRIAL WELDING TRANSFORMER TO MINIMIZE THE IDLING POWER LOSS

A dissertation submitted to the Department of Electrical Engineering,
University of Moratuwa in partial fulfillment of the requirement for the
degree of Master of Science

by

ALAHAKOONGE, DON MIKE JEETH

Supervised by Dr. Nalin Wickramarachchi

Department of Electrical Engineering
University of Moratuwa
Sri Lanka

2009

93952



Abstract

Main objective is to design and implement automated control circuit to switch ON & OFF main power feeding contactor of industrial welding transformer, depend on the work pattern. Voltage sensing at the out put terminals of secondary winding of welding transformer is used as a one and only input signal for the control circuit. Reduced voltage 24 VAC is supplied to primary during idling and during operation it converts in to 400 VAC, and this conversion takes place automatically. By that, able to reduce idling power loss on primary winding due to open circuit core loss & iron loss.

During designing of new system special attention was made, not to change existing conventional welding procedure and not to introduce additional external sensors and cables other than conventional welding electrode and welding cable.

New system was practically implemented in yard and tested for long period of time in different work conditions in Colombo Dockyard PLC. System was tested with existing conventional welders but no behavioral changes were observed during welding operation after implementing new system. Successful trails were carried out and proved it uninterrupt operation.

Under guidance and instructions of my project supervisor I worked and finally able to came up with practically feasible solution. This report describes problem identification, how the design concept developed, power saving and cost benefits .to yard after implementation of new system.

The report starts with an introduction as a 1st chapter where describe the current welding practice at Colombo Dockyard PLC, how to reduce idling power loss by implementing new method and final goal of my project. 2nd chapter describes the statement of the problem and problem identification, new solution and how it affects to save energy.



The 3rd chapter consists with gathered technical data and its analysis during execution of design approach.

Next 4th chapter describe about proposed and implemented solutions for the identified problem and evolution of design concept.

Fifth chapter describes the energy saving calculations and cost benefit analysis. Finally, in the conclusion, I have explained practically and economically viability of new product as a industrial product.

DECLARATION

The work submitted in this dissertation is the result of my own investigation, except where otherwise stated.

It has not already been accepted for any degree, and is also not being concurrently submitted for any other degree.

UOM Verified Signature University of Moratuwa, Sri Lanka.
Electronic Theses & Dissertations
v.lib.mrt.ac.lk

Date: April 30, 2009

We/ I endorse the declaration by the candidate

UOM Verified Signature

Project supervisor: Dr. Nalin Wickramarachchi

CONTENTS

Declaration	i
Abstract	v
Acknowledgement	vii
Table of content	ii
List of Figures	viii
List of Tables	ix
1. Introduction	1
1.1 Background about Colombo Dockyard PLC	1
1.2 Basic Introduction for current work practice at Colombo Dockyard PLC	1
1.2.1 Current welding procedure which is practicing at yard	1
1.2.2 Energy wastage during idle period due to open circuit core loss & iron loss	2
1.2.3 Specification & general configuration of Welding Transformer at Colombo Dockyard PLC	3
1.2.4 Utilization of arc welding transformers in Colombo Dockyard PLC	4
1.3 Goals and Scope of present work	5
2. Statement of the Problem	6
2.1 Preliminaries	6
2.2 Problem identification & Thesis statement	7

3. Gathered technical data and its Analysis during execution of design approach	8
3.1 CT out put current and voltage measurements which Relevant to each of CT under current sensing design approach	8
3.2 Measured parameters during voltage sensing design	10
3.3 Following are the measured values of primary and secondary parameters when secondary under load	11
3.4 Behavioral study of welding transformer by connecting various types of step down transformers parallel to primary winding of welding transformer	12
3.5 Measuring of total idling time and study of operator's behavioral pattern which relevant to each work location	14
3.5.1 Why idling can not eliminate during steel fabrication process	14
3.5.2 Instrument used to measure the idling time and to study operator's work pattern	15
3.5.3 Sample screen shots during study of operator's work pattern from above SCOPE meter	16
3.5.4 Data collected which relevant to each work location to measure total idling time for 10 hours of total time period	17
3.5.5 Study of operator's work pattern during general welding operation in order to decide the best timer setting which relevant to voltage sensing approach	21
4. Proposed and implemented solutions	26
4.1 Design approach and evolution of design concept	26
4.2 Design concept – 1	27
4.3 Design concept – 2 (Current sensing approach)	27
4.3.1 Why current sensing approach was not feasible	28

4.4 Design concept – 3 (Voltage sensing approach No – 1)	29
4.4.1 Operating procedure	29
4.5 Design concept – 4 {Final} , Voltage sensing approach No – 2	32
4.5.1 Difference between Design concept – 3 & Design concept – 4	32
4.5.2 Calculation of resister value for Variable resister which has used in control circuit	34
4.6 Operation procedure according to the final design	35
4.7 Functional block diagram according to the final design	37
5. Energy saving calculations and cost benefit analysis	38
5.1 Material used for control circuit and their cost	38
5.2 Measuring of actual active power consumption of welding T/F when idling with out implementing new system	39
5.3 Energy saving calculation	39
5.4 Calculation of simple pay back period	40
5.5 Comparison between active power consumption of welding T/F when idling with & with out implementing new system	40
6. Conclusion	42
References	43
APPENDIX – A Sample screen shots during study of operator’s work pattern from FLUKE SCOPE meter	44
APPENDIX – B Literature about instrument and equipments which were used	49

Acknowledgement

I express my sincere thanks to all the following individuals, those who contributed towards the completion of my final project successfully under my M.Sc/PG Diploma in Industrial Automation 2006/07 course.

At the very beginning my gratitude goes to the project supervisor Dr. Nalin Wickramarachchi, senior lecturer, department of electrical engineering, University of Maratuwa. I am indebted to my project supervisor for his immense guidance and excellent technical advices for success of my project. I would like to extend my sincere thanks to Prof. J. Rohan Lucas, Prof. H.Y. Ranjit Perera, Head department of electrical engineering Prof. J.P. Karunadasa,

Prof.Lanka Udawatta and Dr. Sisil Kumarawadu who gave their valuable advices for success of my project. I would like to take this opportunity to deliver my sincere thank to MD/CEO Mr. Mangala P.B. Yapa and Mr. D.A.P Senasinghe, Assistant Production Manager (Electrical and Automation) for their guidance and opportunity given to me to initiate and execute my project within the yard premises. Again thankful to Mr. D.A.P Senasinghe for his technical advices and immense guidance for the success of my project.

My sincere thanks should also go to the young engineers specially Mr. E. M. M. B Yatiyana and Mr. P. H. K. H Puhulwella in the Electrical and Automation Department. They positively contributed me for the success of my project. Also tanks should also go to electrical workshop engineer Mr. H.R.K.K. Ariyaratne too.

My thanks also go to the instrument technicians from automation workshop who worked under me. Appreciate their work during gathering field data and during execution of project in real situation. I am again thankful to the all of above and success of my project mainly depends upon the help and support given by them.

A.D.M.Jeeth.

April 30, 2009

List of Figures

Figure	Page No
Figure 1.1 - General configuration of welding transformer	4
Figure 3.1 - General arrangement of welding transformer	8
Figure 3.2 – Transformer with external devices during behavioral study	12
Figure 3.3 – Sample screen shots during study of operator’s work pattern	16
Figure 3.4 – Graphical representation of measured average idling periods which relevant to each work location	20
Figure 3.5 – Study of operator’s work pattern during each continuous welding run	21
Figure 3.6 – Graphical representation of summarized measured average idling periods during each continuous welding run for each work location	25
Figure 4.1 - Circuit diagram which relevant to Design concept 2	28
Figure 4.2 - Circuit diagram which relevant to Design concept 3	31
Figure 4.2 - Circuit diagram which relevant to Design concept 4	33
Figure 4.4 – Resistor arrangement to maintain required voltage across relay (R_1)	34
Figure 4.5 - Functional block diagram according to the final design	37

List of Tables

Table	Page No
Table 1.1 – Measured power consumption during idling when 400 VAC gets connects with primary	3
Table 1.2 – Utilization of arc welding transformers in Colombo Dockyard PLC	4
Table 3.1 - CT out put current and voltage measurements with CT Ration: 100 / 5 A & $V_1 = 24$ VAC	8
Table 3.2 - CT out put current and voltage measurements with CT Ration: 100 / 5 A & $V_1 = 400$ VAC	9
Table 3.3 - CT out put current and voltage measurements with CT Ration: 400 / 5 A & $V_1 = 24$ VAC	9
Table 3.4 - CT out put current and voltage measurements with CT Ration: 400 / 5 A & $V_1 = 400$ VAC	10
Table 3.5 - Measured values of I_1 & V_2 by varying transformer current setting	10
Table 3.6 - Measured values of primary and secondary parameters when secondary under load and $V_1 = 400$ VAC	11
Table 3.7 - Measured values of primary and secondary parameters when secondary under load and $V_1 = 24$ VAC	11
Table 3.8 - Measured values of primary and secondary parameters when secondary under load and $V_1 = 48$ VAC	11
Table 3.9 – Readings during behavioral study @ $V_1 = 24$ V AC with 110 VAC / 24 VAC step down transformer	13
Table 3.10 – Readings during behavioral study @ $V_1 = 48$ V AC with 110 VAC / 24 VAC step down transformer	13
Table 3.11 – Readings during behavioral study @ $V_1 = 220$ V AC with 110 VAC / 24 VAC step down transformer	13
Table 3.12 – Readings during behavioral study @ $V_1 = 400$ V AC with 110 VAC / 24 VAC step down transformer	14

Table 3.13 – Readings during behavioral study @ $V_1 = 400$ V AC with 80 VAC / 12 VAC step down transformer	14
Table 3.14 – Measured idling periods at Yard welding pool	17
Table 3.15 – Measured idling periods at Metal Workshop (MEW)	17
Table 3.16 – Measured idling periods at Pipe Fabrication workshop (PFS)	17
Table 3.17 – Measured idling periods at Deck fitting workshop (FIS DEC)	18
Table 3.18 – Measured idling periods at Steel workshop	18
Table 3.19 – Measured idling periods at Component workshop (COM)	18
Table 3.20 – Measured idling periods at Machinery outfitting workshop (MOF)	19
Table 3.21 – Summary of measured average idling periods which relevant to each work location	19
Table 3.22 – Measured idling period during each continuous welding run, Location: Yard welding pool	22
Table 3.23 – Measured idling period during each continuous welding run, Location: Metal Workshop (MEW)	22
Table 3.24 – Measured idling period during each continuous welding run, Location: Pipe Fabrication workshop (PFS)	22
Table 3.25 – Measured idling period during each continuous welding run, Location: Deck fitting workshop (FIS DEC)	23
Table 3.26 – Measured idling period during each continuous welding run, Location: Steel workshop	23
Table 3.27 – Measured idling period during each continuous welding run, Location: Component workshop (COM)	23
Table 3.28 – Measured idling period during each continuous welding run, Location: Machinery outfitting workshop (MOF)	24
Table 3.29 – Summary of measured average idling period during each continuous welding run, For each work location	24

Table 4.1 - Measured data by varying V_1 when secondary in open circuit (no load)	26
Table 5.1 – Material list for one unit with their prices	38
Table 5.2 - Measured data about active power consumption of welding T/F when idling with out implementing new system	39
Table 5.3 – Reading observed from energy meter	40
Table 5.4 – Actual energy consumption after deducting initial meter reading	41



University of Moratuwa, Sri Lanka.
Electronic Theses & Dissertations
www.lib.mrt.ac.lk

Chapter 1

Introduction

1.1 Background about myself and Colombo Dockyard PLC

Colombo Dockyard is the one of the biggest shipyard in Sri Lanka. Main Share Holder is Onomichi Dockyard, Japan. Shipbuilding, Ship Repair, Heavy Engineering and Consultancy & Design Services are the main activities caring out by Colombo dockyard. Today, Colombo Dockyard PLC has earned international recognition as a leading ship repairer and shipbuilder in the South Asia region.

I am an Automation Engineer of Colombo Dockyard PLC and I have been working for last eight years. After obtaining my 1st degree from University of Moratuwa, I joined the Colombo Dockyard PLC as a mechanical engineer on 1st of September 2000. And after 3 years I was appointed as an Automation engineer of the company.



www.lib.mrt.ac.lk

1.2 Basic Introduction for current work practice at Colombo Dockyard PLC

1.2.1 Current welding procedure which is practicing at yard [4]

Colombo Dockyard PLC is heavily using mainly arc welding transformers during ship hull construction, pipe fabrication work and other steel fabrication works. Total numbers of transforms are 685 Nos. According to the basic electrical theories for transformers, it is obvious by reducing the supply voltage to primary winding it can reduce the idling power loss at primary winding when secondary at open circuit (idling).

Welding transformers which are currently being used in Colombo Dockyard don't have any kind of automated control circuit to switch ON & OFF the supply power depend on the work pattern.

As per the existing system, it consist only manual switch for ON/OFF main power. At the beginning of the day operator comes with his welding cable and connects the cable with the welding transformer and subsequently switch ON the transformer and starts his work.

In general during steel fabrication welder should carry out following preparation work in addition to actual welding operation. It can not omit.

- Preparation of fit up
- Bevel preparation
- Grinding
- Gas cutting as per the situation, etc.,

During consecutive continuous welding operations operator has to be carried out above pre preparation operations before next continuous run starts. It can be considerable amount of time and it take 30 minute ,45minute, 1 hour and some times it extends up to 2 or 3 hour depend on the work condition. During that time, transformer may idle. Even though the transformer is idle, as per the existing current practice, 400 VAC [2] gets connects with primary winding and keep on maintain 400 VAC irrespective of the work pattern till the operator switch OFF the transformer by manual switch at the end of the day.

1.2.2 Energy wastage during idle period due to open circuit core loss & iron loss.

As per the existing current practice, during idling time 400 VAC gets connects with primary winding and keep on maintain 400 VAC irrespective of the work pattern. During this idling period secondary winding side is at open circuit. But resultant circulating current (average 10 Amp) f lows through primary winding even transformer at idle condition. Due to this huge circulating current during idling there is a huge energy wastage takes place.

It was measured the active power loss at primary winding during idling, by using active power energy meter.

Specifications of used energy meter, Make: Polyphase Energy meter.

Time @	Reading on energy meter (kWh)
08.30 Hours	2.54
13.53 Hours	6.55
18.48 Hours	10.96

Table 1.1 – Measured power consumption during idling when 400 VAC gets connects with primary

As per above table active power consumption for 10.5 hours = $10.96 - 2.54 = 8.42$ kWh

Total power saving calculation will be described on chapter 5.3.

1.2.3 Specification & general configuration of Welding Transformer at Colombo Dockyard PLC

1.2.3.1 Specification ,as per the User Manual of ESAB Transweld 400 [1,2,4]

Make: ESAB India Limited Kolkata

Model: Transweld 400

Serial No: 0407305

Supply Voltage: 415 V

Frequency : 50 Hz

Rated Input Current: 63 Amp

Input KVA : 26 KVA

Phase: 2 line of 3 Phase

Current Range: 80A – 400 A

Operating Circuit Voltage: 80 V

Max Contentions hard welding current at 60 % duty Cycle – 300 A,

Weight: 115 Kg

1.2.3.2 General configuration[3]

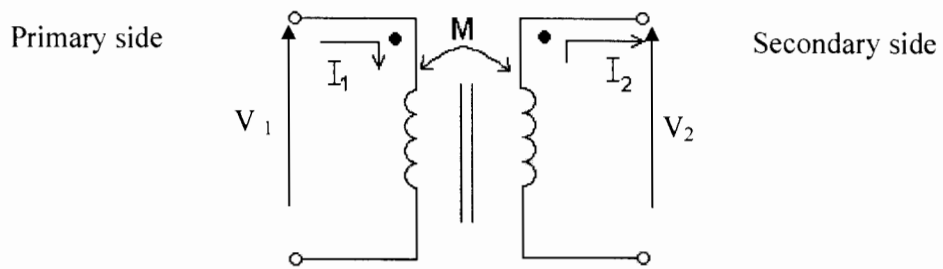

Figure 1.1 – General configuration of welding transformer

V_1 – Supply voltage to primary winding

V_2 – Induced Voltage at secondary winding

I_1 - Circulating current at primary winding

I_2 - Circulating current at secondary winding

R_1 – Total measured resistance of primary winding = 1.0 to 1.3 Ω

R_2 – Total measured resistance of secondary winding = 0.3 to 0.4 Ω

1.2.4 Utilization of arc welding transformers in Colombo Dockyard PLC

Total No of welding transformers in Colombo Dockyard PLC = 685 Nos

Location	No of Transformers
Yard welding pool (Ships on board, new construction work beds, etc.,)	574
Metal Workshop (MEW)	40
Pipe Fabrication workshop (PFS)	10
Deck fitting workshop (FIS DEC)	5
Steel workshop	40
Component workshop (COM)	6
Machinery outfitting workshop (MOF)	10
Total	685

Table 1.2 – Utilization of arc welding transformers in Colombo Dockyard PLC

For every 10 hours total time duration, due to idling it will waste 8 kWh for each transformer unit. Total No of T/F is being used in yard is around 685 Nos.

1.3 Goals and Scope of present work

During above mentioned idling period secondary winding is at open circuit. But due to resultant circulating current (average 10 Amp) flow through primary winding, even transformer at idle condition. Due to this huge circulating current there is a huge energy wastage takes place. By reducing the supply voltage from 400 VAC to 24 VAC, can reduce no load current at primary winding from around 10 A to 0.1A.

By injecting reduced voltage (24 VAC) to the primary, able to provide signal to main power feeding contactor to switch “ON” & “OFF” depend upon the work pattern of the operator.

Goal was to invent, design and implement automated control circuit to feed 24 VDC to primary during idling and subsequently if it needs to perform actual welding then automatically 400 VAC gets connect with primary winding. Then welding transformer is ready for welding operation. Subsequently by monitoring idling time duration, if it is more than 3 minutes (most effective time period which was found out from research), it again connects with 24 VAC automatically to save power.

Finally new system was practically implemented in yard and tested for long period of time in different work conditions in Colombo Dockyard PLC. System was tested with existing conventional welders but after implementing new system no behavioral changes were observed during their welding operation. During designing of new system special attention was made not to change existing conventional welding procedure and not to introduce additional external sensors and cables other than conventional welding electrode and cable.

Successful trails were carried out and proved it un-interrupted operation.

Chapter 2

Statement of the Problem

2.1 Preliminaries

Colombo Dockyard PLC is heavily using mainly arc welding transformers during ship hull construction, pipe fabrication work and other steel fabrication works. Total numbers of transforms are 685 Nos.

As per the existing current practice, during idling time also 400 VAC gets connects with primary winding and keep on maintain 400 VAC irrespective of the work pattern. During this idling period secondary winding side is at open circuit. But resultant circulating current (average 10 Amp) flows through primary winding even transformer at idle condition. Due to this huge circulating current during idling there is a huge energy wastage takes place.

In order to avoid above unnecessary energy wastage during idling only action taken by yard is displaying of sign board on welding transformer by giving instructions to operator to switch off the plant when not in use.

According to the basic electrical theories for transformers, it is obvious by reducing the supply voltage to primary winding it can reduce the idling power loss at primary winding when secondary at open circuit (at idling).

Welding transformers which are currently being used in Colombo Dockyard don't have any kind of automated control circuit to switch ON & OFF the supply power depend on the work pattern. As per the existing system, it consist only manual switch for ON/OFF main power.

At the beginning of the day operator comes with his welding cable and connects the cable with the welding transformer and subsequently switch ON the transformer and starts his work and subsequently keep “ON” the plant till the operator finishes his work for the day.

2.2 Problem identification & Thesis statement

Instruction signboard which was displayed on arc welding transformers which are currently being used in Colombo Dockyard PLC is the initiation point of the project concept. Subjected sign board gives some instructions to operator. It says to **“SWITCH OFF THE WELDING TRANSFORMER WHEN NOT IN USE”**. This sign board directed me to find automated solution to switch OFF the transformer when not in use and simultaneously it gets switch ON automatically when operator need to perform welding operations. By that able to reduce idling power loss on primary winding due to open circuit core loss & iron loss.

Above idea was executed as my final project under my M.Sc/PG Diploma in Industrial Automation 2006/07 course. Named the project as “Automated control circuit for industrial welding transformer to minimize idling power loss”

Chapter 3

Gathered technical data and its Analysis during execution of design approach

3.1 Following are the some of CT out put current and voltage measurements which relevant to each of CT under current sensing design approach

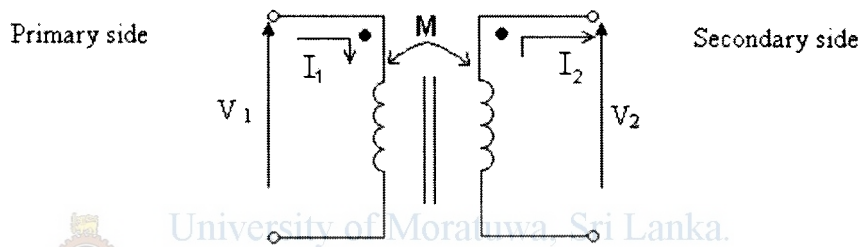

Figure 3.1 - General arrangement of Welding Transformer

1. $V_1 = 24 \text{ VAC}$:

➤ CT Ratio: $100 / 5 \text{ A @ primary side}$

Serial No	Set loading value condition of T/F (ie: Max Current level)	CT Voltage out put (V)	CT Current out put (A)
1	100	0.1 to 0.2	0.02
2	200	0.30	0.06
3	300	0.61	0.11
4	400	0.76	0.17

Table 3.1 - CT out put current and voltage measurements with CT Ratio: $100 / 5 \text{ A}$ & $V_1 = 24 \text{ VAC}$

2. $V_1 = 400$ VAC:

➤ CT Ratio: 100 / 5 A @ primary side

Serial No	Set loading value condition of T/F (ie: Max Current level)	CT Voltage out put (V)	CT Current out put (A)
1	No load	0.87	0.20
2	100	0.96	0.96
3	200	0.99	1.54
4	300	1.01	2.21
5	400	1.03	2.92

Table 3.2 - CT out put current and voltage measurements with CT Ratio: 100 / 5 A & $V_1 = 400$ VAC



University of Moratuwa, Sri Lanka.
Electronic Theses & Dissertations
www.lib.mrt.ac.lk

3. $V_1 = 24$ VAC:

➤ CT Ratio: 400 / 5 A @ Secondary side

Serial No	Set loading value condition of T/F (ie: Max Current level)	CT Voltage out put (V)	CT Current out put (A)
1	100	3.35	0.04
2	200	3.30	0.10
3	300	2.95	0.17
4	400	2.64	0.24

Table 3.3 - CT out put current and voltage measurements with CT Ratio: 400 / 5 A & $V_1 = 24$ VAC

4. $V_1 = 400$ VAC:

➤ CT Ratio: 400 / 5 A @ Secondary side

Serial No	Set loading value condition of T/F (ie: Max Current level)	CT Voltage out put (V)	CT Current out put (A)
1	100	0.21	1.1
2	200	0.39	2.02
3	300	0.57	2.9
4	400	0.77	3.9

Table 3.4 - CT out put current and voltage measurements with CT Ratio: 400 / 5 A & $V_1 = 400$ VAC



University of Moratuwa, Sri Lanka.
Electronic Theses & Dissertations
www.lib.mrt.ac.lk

3.2 Measured parameters during voltage sensing design

Following are the measured values of I_1 & V_2 by varying transformer current setting (using current changing regulator) with the constant $V_1 = 400$ VAC

This data was gathered relevant to voltage sensing design approach

Set T/F loading condition	I_1 (A)	V_2 (V AC)
100	4.0	67.5
200	4.2	70.9
300	4.7	73.0
400	4.9	74.4

Table 3.5 - Measured values of I_1 & V_2 by varying transformer current setting

3.3 Following are the measured values of primary and secondary parameters when secondary under load.

This data was gathered relevant to voltage sensing design approach

➤ $V_1 = 400 \text{ VAC}$:

Serial No	Set loading value of secondary winding (Max Current at secondary winding)	I_1 (A)	I_2 (A)	V_2 (V AC)
1	100	19.7	96.9	26.0
2	200	32.7	154.9	27.9
3	300	42.0	217.0	40.0
4	400	61.5	270.0	42.8

Table 3.6 - Measured values of primary and secondary parameters when secondary under load and $V_1 = 400 \text{ VAC}$

➤ $V_1 = 24 \text{ VAC}$:

Serial No	Set loading value of secondary winding (Max Current at secondary winding)	I_1 (A)	I_2 (A)	V_2 (V AC)
1	100	1.2	5.4	0.20
2	200	2.1	10.5	0.39
3	300	3.1	15.7	0.29
4	400	4.3	21.7	0.58

Table 3.7 - Measured values of primary and secondary parameters when secondary under load and $V_1 = 24 \text{ VAC}$

➤ $V_1 = 48 \text{ VAC}$:

Serial No	Set loading value of secondary winding (Max Current at secondary winding)	I_1 (A)	I_2 (A)	V_2 (V AC)
1	100	2.1	10.27	0.36
2	200	3.6	18.12	0.42
3	300	4.5	21.0	0.78
4	400	5.9	29.7	0.65

Table 3.8 - Measured values of primary and secondary parameters when secondary under load and $V_1 = 48 \text{ VAC}$

3.4 Behavioral study of welding transformer by connecting various types of step down transformers parallel to primary winding of welding transformer.

In the case of voltage sensing design approach signal to be obtain by connecting small step down transformer with the secondary winding of welding transformer.

Behavior was studied by connecting various types step down transformers parallel to primary winding of welding transformer.

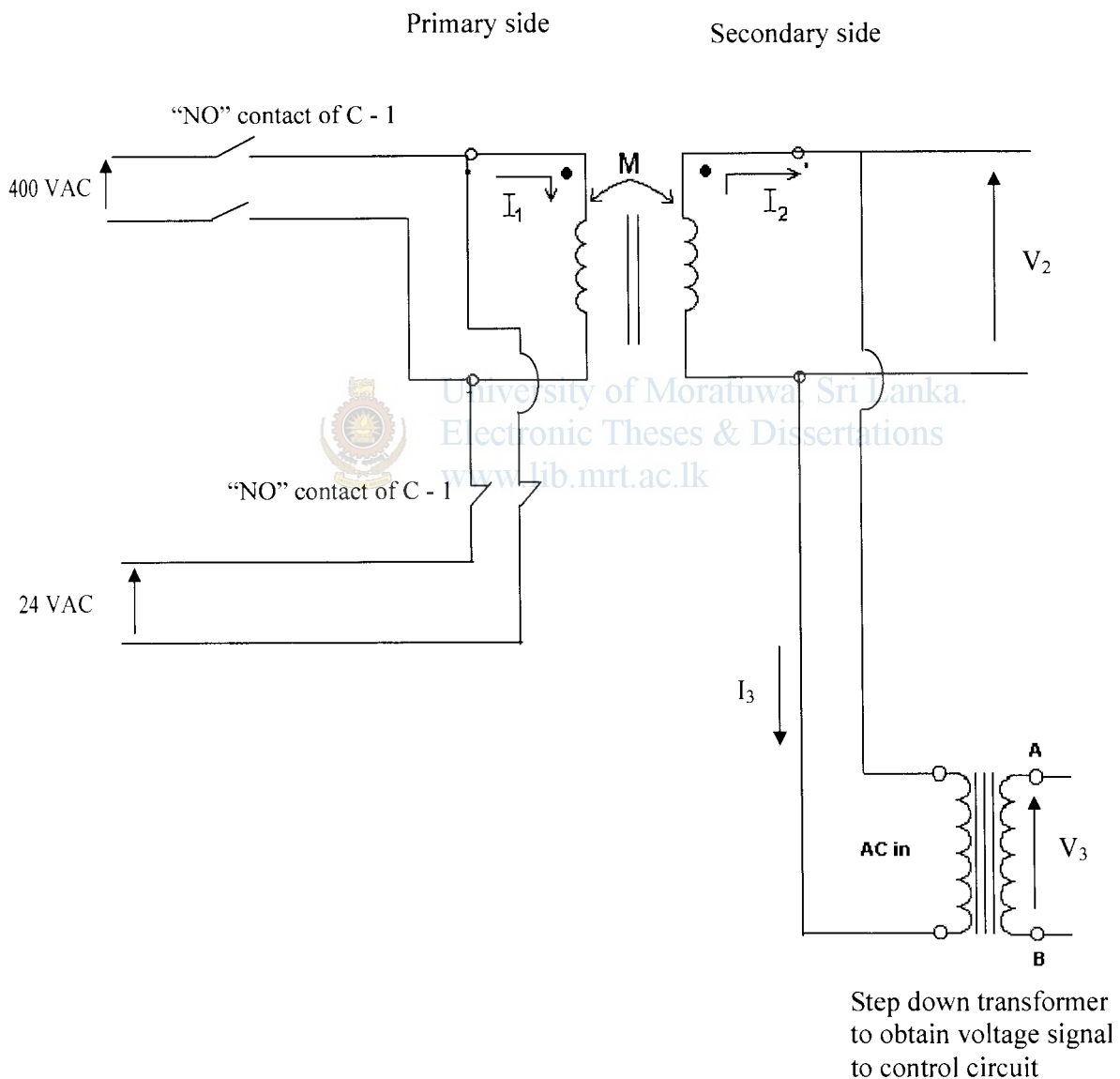

Figure 3.2 – Transformer with external devices during behavioral study

Relevant readings are as follows;

@ $V_1 = 24 \text{ V AC}$ with 110 VAC / 24 VAC

Ser. No	Set loading Condition	During welding (On load)				Open circuit (No load)		
		I_2 (A)	I_3 (mA)	V_2 (V)	V_3 (V)	V_2 (V)	V_3 (V)	I_3 (mA)
1	100	6.47	0.79	0.18	0.084	4.59	1.27	7.77
2	200	10.60	0.84	0.18	0.047	4.83	1.35	7.95
3	300	15.86	1.20	0.27	0.080	4.81	1.37	8.01
4	400	22.5	1.58	0.39	0.117	4.86	1.40	8.03

Table 3.9 – Readings during behavioral study @ $V_1 = 24 \text{ V AC}$ with 110 VAC / 24 VAC step down transformer.

@ $V_1 = 48 \text{ V AC}$ with 110 VAC / 24 VAC

Ser. No	Set loading Condition	During welding (On load)				Open circuit (No load)		
		I_2 (A)	I_3 (mA)	V_2 (V)	V_3 (V)	V_2 (V)	V_3 (V)	I_3 (mA)
1	100	9.7	0.77	0.19	0.051	9.21	2.38	10.48
2	200	16.7	1.51	0.45	0.096	9.46	2.50	10.61
3	300	23.1	1.57	0.39	0.097	9.59	2.50	10.74
4	400	29.6	2.05	0.63	0.105	9.69	2.52	10.88

Table 3.10 – Readings during behavioral study @ $V_1 = 48 \text{ V AC}$ with 110 VAC / 24 VAC step down transformer.

@ $V_1 = 220 \text{ V AC}$ with 110 VAC / 24 VAC

Ser. No	Set loading Condition	During welding (On load)				Open circuit (No load)		
		I_2 (A)	I_3 (mA)	V_2 (V)	V_3 (V)	V_2 (V)	V_3 (V)	I_3 (mA)
1	100	55.5	2.53	0.88	0.42	43.4	12.0	20.54
2	200	104.5	3.61	1.55	0.59	44.3	12.27	20.81
3	300	108	15.6	24	6.63	44.6	12.34	20.81
4	400	148	15.6	26	6.5 to 8.65	44.7	12.56	20.77

Table 3.11 – Readings during behavioral study @ $V_1 = 220 \text{ V AC}$ with 110 VAC / 24 VAC step down transformer.

@ $V_1 = 400$ V AC with 110 VAC / 24 VAC

Ser. No	Set loading Condition	During welding (On load)				Open circuit (No load)		
		I_2 (A)	I_3 (mA)	V_2 (V)	V_3 (V)	V_2 (V)	V_3 (V)	I_3 (mA)
1	100	93	14 to 19	23 to 29	5.5 to 8.5	68.0	19.15	32.84
2	200	140	16.65	33 to 37	7.6	71.0	17.37	34.22
3	300	202	16.6	57	11.2	72.8	19.84	35.25
4	400	286	22.4	59	10.4	74.5	19.13	35.65

Table 3.12 – Readings during behavioral study @ $V_1 = 400$ V AC with 110 VAC / 24 VAC step down transformer.

@ $V_1 = 400$ V AC with 80 VAC / 12 VAC (Resistance of primary winding – 40.9Ω & resistance of secondary winding – 1.7Ω)

Ser. No	Set loading Condition	During welding (On load)				Open circuit (No load)		
		I_2 (A)	I_3 (mA)	V_2 (V)	V_3 (V)	V_2 (V)	V_3 (V)	I_3 (mA)
1	100	93.9	6.2	21 to 27	3.8 to 6.0	68.4	10.44	22.9
2	200	162.1	7.6	33.7	4.8 to 6.0	71.9	10.95	25.8
3	300	186.3	9.7	43.7	5.3 to 7.1	73.2	11.19	27.1
4	400	308.0	10.4	48.3	6.4 to 7.2	75.2	11.48	28.6

Table 3.13 – Readings during behavioral study @ $V_1 = 400$ V AC with 80 VAC / 12 VAC step down transformer.

3.5 Measuring of total idling time and study of operator's behavioral pattern which relevant to each work location.

3.5.1 Why idling can not eliminate during steel fabrication process

In general during steel fabrication welder should carry out following preparation work in addition to actual welding operation.

- Preparation of fit up
- Bevel preparation
- Grinding
- Gas cutting as per the situation, etc.,

During consecutive continuous welding operations operator has to be carried out above pre preparation operations before next continuous run starts. It can be considerable amount of time and it take 30 minute ,45minute, 1 hour and some times it extends up to 2 or 3 hour depend on the work condition. During that time transformer may idled.

3.5.2 Instrument used to measure the idling time and to study operator's work pattern

By using data logger idling time was measured.

Specification of used data logger:

Name of instrument: Fluke View Scope meter [5]

Make: Fluke

Model: 105B Series – II

Serial No: DM6720399



University of Moratuwa, Sri Lanka.
Electronic Theses & Dissertations
www.lib.mrt.ac.lk

Above instrument was connected with the out put terminals of secondary winding of the welding transformer and it continuously measures the RMS value of terminal voltage. **During idling it is 80 VAC and during operation it drops. By monitoring that voltage level difference, I analyzed the operators welding pattern & total idling time duration.** It was measured which relevant for each work locations and repeated samples were considered. Measurements were taken within 10 hours period for each location.

3.5.3 Sample screen shots during study of operator's work pattern from above SCOPE meter

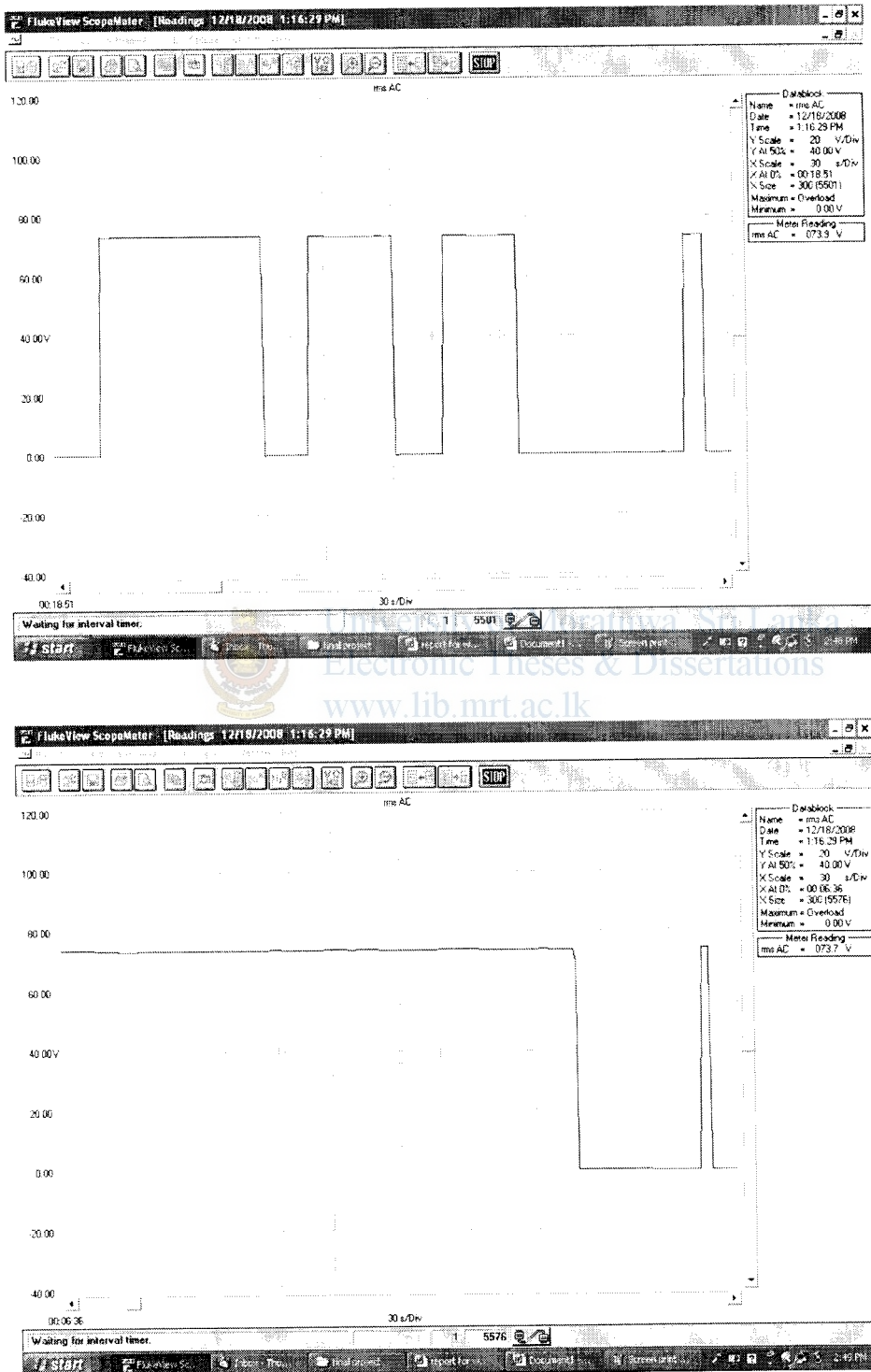

Figure 3.3 – Sample screen shots during study of operator's work pattern

3.5.4 Data collected which relevant to each work location to measure total idling time for 10 hours of total time period.

Total idling time which relevant to each of following work locates was measured and following are the summarized measured values data. This totalized idling time is measured for total 10 hours period. It was repeated for 5 days.

Location: Yard welding pool (Ships on board, new construction work beds, etc.,

Sample No	Date	Idling Time duration (Hours)
1	2008/10/26	7.50
2	2008/10/27	6.80
3	2008/10/28	5.30
4	2008/10/29	6.50
5	2008/10/30	6.75

Table 3.14 – Measured idling periods at Yard welding pool

Out of 10 hours, average total idling duration: 6.57 Hrs

Location: Metal Workshop (MEW)

Sample No	Date	Idling Time duration (Hours)
1	2008/10/31	9.40
2	2008/11/01	7.60
3	2008/11/02	8.75
4	2008/11/03	7.25
5	2008/11/04	6.75

Table 3.15 – Measured idling periods at Metal Workshop (MEW)

Average: 7.95 Hrs

Location: Pipe Fabrication workshop (PFS)

Sample No	Date	Idling Time duration (Hours)
1	2008/11/05	5.20
2	2008/11/06	4.60
3	2008/11/07	6.00
4	2008/11/08	6.25
5	2008/11/09	6.50

Table 3.16 – Measured idling periods at Pipe Fabrication workshop (PFS)

Average: 5.71 Hrs

Location: Deck fitting workshop (FIS DEC)

Sample No	Date	Idling Time duration (Hours)
1	2008/11/10	4.25
2	2008/11/11	5.50
3	2008/11/12	4.75
4	2008/11/13	3.50
5	2008/11/14	6.25

Table 3.17 – Measured idling periods at Deck fitting workshop (FIS DEC)

Average : 4.85 Hrs

Location: Steel workshop

Sample No	Date	Idling Time duration (Hours)
1	2008/11/15	7.25
2	2008/11/16	7.60
3	2008/11/17	7.00
4	2008/11/18	6.50
5	2008/11/19	6.00

Table 3.18 – Measured idling periods at Steel workshop

Average : 6.87 Hrs

Location: Component workshop (COM)

Sample No	Date	Idling Time duration (Hours)
1	2008/11/20	3.25
2	2008/11/21	5.50
3	2008/11/22	4.75
4	2008/11/23	6.25
5	2008/11/24	7.00

Table 3.19 – Measured idling periods at Component workshop (COM)

Average : 5.35 Hrs

Location: Machinery outfitting workshop (MOF)

Sample No	Date	Idling Time duration (Hours)
1	2008/11/25	6.50
2	2008/11/26	4.75
3	2008/11/27	5.50
4	2008/11/28	5.25
5	2008/11/29	7.25

Table 3.20 – Measured idling periods at Machinery outfitting workshop (MOF)

Average : 5.85 Hrs

Summary:

Location	No of Transformers	Average idling time for 10 hours total operation for individual T/F unit (Hours)
Yard welding pool (Ships on board, new construction work beds, etc.,	574	6.57
Metal Workshop (MEW)	40	7.95
Pipe Fabrication workshop (PFS)	10	5.71
Deck fitting workshop (FIS DEC)	5	4.85
Steel workshop	40	6.87
Component workshop (COM)	6	5.35
Machinery outfitting workshop (MOF)	10	5.85
Total	685	43.15

Table 3.21 – Summary of measured average idling periods which relevant to each work location

**Average idling time for 10 hours total operation for individual T/F unit (Hours)
VS Work Location**

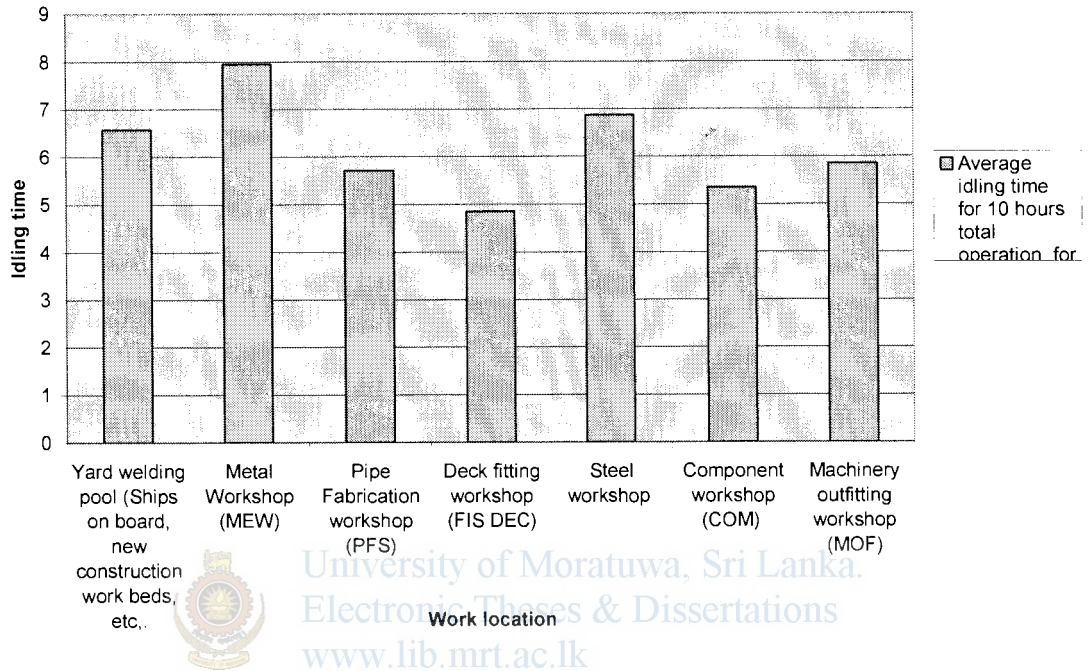

Figure 3.4 – Graphical representation of measured average idling periods which relevant to each work location

Average idling for individual T/F unit at each work location for total 10 hours duration = $43.15 / 7 = 6.16$ Hours

3.5.5 Study of operator's work pattern during general welding operation in order to decide the best timer setting which relevant to voltage sensing approach.

This pattern was studied with in one continuous welding run.

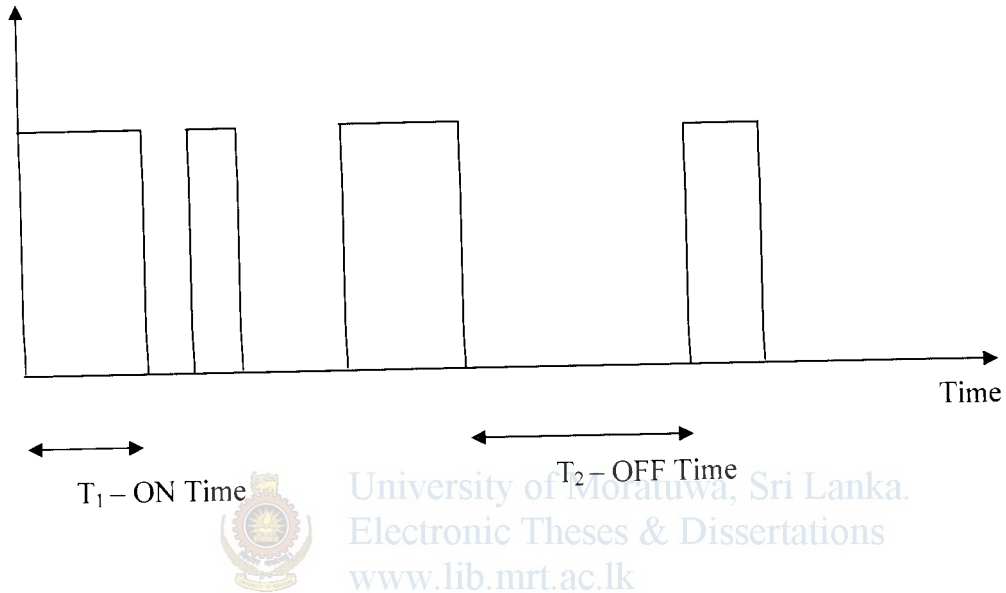

Figure 3.5 – Study of operator's work pattern during each continuous welding run

T_1 - Time for actual continuous welding operation

T_2 - Time for idling within the consecutive continuous welding operation with in one continuous run.

Studied the work pattern and measured the above T_1 & T_2 values which relevant to each work locations. Found that during continuous welding operation, the operator takes small brake to change the welding electrodes, etc. In order to determine that time period, used the same data logger as mentioned above.

Following are the summarized measured values.

Location: Yard welding pool (Ships on board, new construction work beds, etc.,

Date : 2008/10/26

Idling sample No	T ₂ idling time with in one continuous welding run (Sec)
1	165
2	150
3	160
4	180
5	175

Table 3.22 – Measured idling period during each continuous welding run,
Location: Yard welding pool

Average idling duration: 166 Sec = 2.7 minutes

Location: Metal Workshop (MEW)

Date: 2008/10/31

Idling sample No	T ₂ idling time with in one continuous welding run (Sec)
1	50
2	80
3	110
4	85
5	70

Table 3.23 – Measured idling period during each continuous welding run,
Location: Metal Workshop (MEW)

Average idling duration: 79 Sec = 1.3 minutes

Location: Pipe Fabrication workshop (PFS)

Date: 2008/11/05

Idling sample No	T ₂ idling time with in one continuous welding run (Sec)
1	120
2	150
3	165
4	110
5	95

Table 3.24 – Measured idling period during each continuous welding run,
Location: Pipe Fabrication workshop (PFS)

Average idling duration: 128 Sec = 2.1 minutes

Location: Deck fitting workshop (FIS DEC)
Date: 2008/11/10

Idling sample No	T ₂ idling time with in one continuous welding run (Sec)
1	70
2	55
3	130
4	140
5	165

Table 3.25 – Measured idling period during each continuous welding run,
Location: Deck fitting workshop (FIS DEC)

Average idling duration: 112 Sec = 1.8 minutes

Location: Steel workshop
Date: 2008/11/15

Idling sample No	T ₂ idling time with in one continuous welding run (Sec)
1	100
2	135
3	80
4	175
5	160

Table 3.26 – Measured idling period during each continuous welding run,
Location: Steel workshop
Average idling duration: 130 Sec = 2.1 minutes

Location: Component workshop (COM)
Date: 2008/11/20

Idling sample No	T ₂ idling time with in one continuous welding run (Sec)
1	65
2	50
3	80
4	140
5	120

Table 3.27 – Measured idling period during each continuous welding run,
Location: Component workshop (COM)
Average idling duration: 91 Sec = 1.5 minutes

Location: Machinery outfitting workshop (MOF)
 Date: 2008/11/25

Idling sample No	T ₂ idling time with in one continuous welding run (Sec)
1	85
2	95
3	105
4	170
5	165

Table 3.28 – Measured idling period during each continuous welding run,
 Location: Machinery outfitting workshop (MOF)

Average idling duration: 124 Sec = 2.0 minutes



University of Moratuwa, Sri Lanka.
 Electronic Theses & Dissertations
www.lib.mrt.ac.lk

Summary:

Location	T ₂ idling time with in one continuous welding run (minutes)
Yard welding pool (Ships on board, new construction work beds, etc.,)	2.7
Metal Workshop (MEW)	1.3
Pipe Fabrication workshop (PFS)	2.1
Deck fitting workshop (FIS DEC)	1.8
Steel workshop	2.1
Component workshop (COM)	1.5
Machinery outfitting workshop (MOF)	2.0

Table 3.29 – Summary of measured average idling period during each continuous welding run, For each work location

Average: 115.7 Sec = 1.92 minutes

T2 idling time with in one continuous welding run (minutes) VS Work location

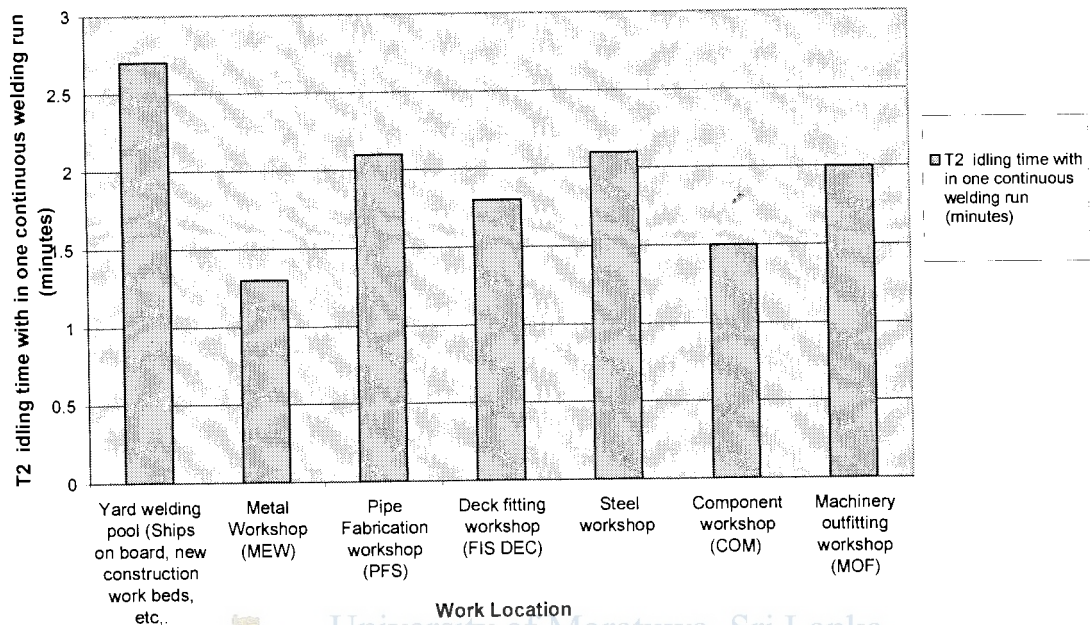

University of Moratuwa, Sri Lanka.
Electronic Theses & Dissertations

Figure 3.6 – Graphical representation of summarized measured average idling periods during each continuous welding run for each work location

Idling time with in one continuous welding run is nearly below 3 minuets.

By considering above and other all practical aspects decided to keep general timer setting as 3 minuets. But operator can change it further depend on the operator’s work pattern. Adjusting facility for timer setting was provided by the proposed control circuit. If operator needs to change he can change it accordingly.

Chapter 4

Proposed and implemented solutions

4.1 Design approach and evolution of design concept

Circulating open circuit current was measured at primary depends on the input supply voltage

Following are the measured data by varying V_1 when secondary in open circuit (no load)

V_1 (V AC)	I_1 (A)	V_2 (V AC)	I_2 (A)
24	0.1 to 0.2	4.49	0
48	0.3	9.31	0
110	1.6	10.7	0
220	7.4	44.0	0
400	10.3	74.4	0

Table 4.1 - Measured data by varying V_1 when secondary in open circuit (no load)

It is obvious when reducing the supply voltage to primary winding (V_1) it is drastically reduced that the no load circulating current (I_1) at primary winding. Due to heavy no load circulating current at primary winding there is a huge power loss when transformer at idling. By supplying reduced voltage to primary winding can reduce the idling power loss.

4.2 Design concept – 1

At the beginning of project tried to develop control strategy by keeping primary winding of welding transformer at open circuit. Tried to find sensing method, by implementing vibration sensor or by injecting high frequency signal to the system. But unable to come up with feasible and economical solution.

4.3 Design concept – 2 (Current sensing approach)

Next decided to feed reduce voltage to primary winding and subsequently tried to developed control strategy by sensing circulating current at primary and secondary windings. Two current transformers (CT) were introduced to the system. One is for primary winding (having rating 100A / 5 A) and other is for secondary winding (having rating 400 A / 5 A). Primary side CT is to sense initial starting and secondary side CT is to sense actual welding operation during continuous welding run. Both CT signals were subsequently fed to one current sensing relay module, one at a time and tried to obtain out put from it.

4.3.1 Why current sensing approach was not feasible.

During idling primary side CT (100A / 5 A) connects with current sensing relay through auxiliary “NC” contacts of main power supply feeding contactor. During operation secondary side CT (400 A / 5A) connects with current sensing relay through auxiliary “NO” contacts of main power supply feeding contactor. Expected instant signal from subjected current sensing relay, just after touches the welding electrode with ground. But practically it was failed due to hysteresis characteristics of the current sensing relay. Its minimum hysteresis value is 0.5 % and beyond that unable to reduce. Also the cost of current sensing relay is high. Due to those reasons current sensing approach was not feasible.

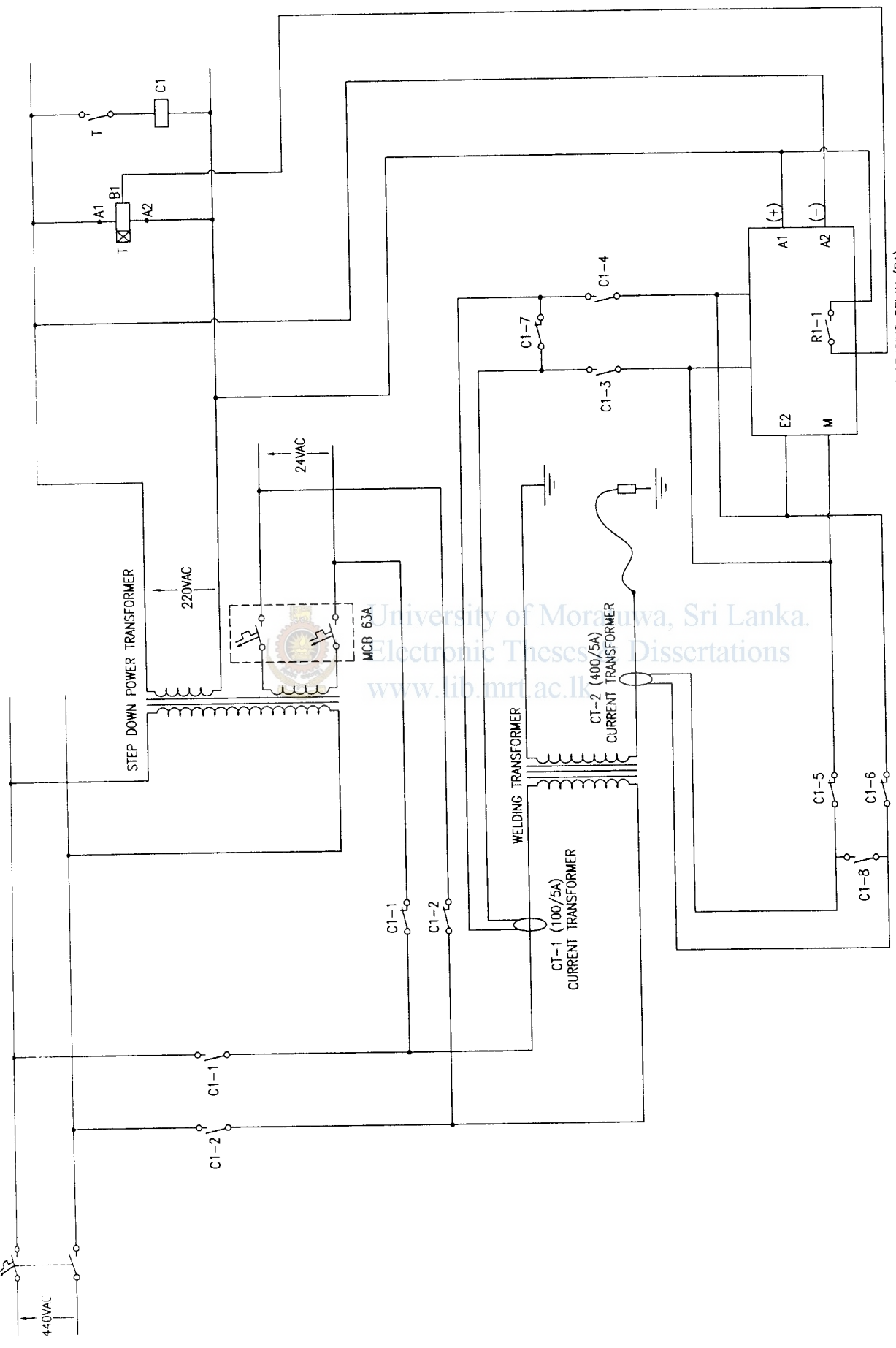

FIG. -4.1 CONTROL CIRCUIT FOR INDUSTRIAL WELDING TRANSFORMER TO ISOLATE PRIMARY WINDING FROM THE 440V AC MAIN SUPPLY DURING IDLING (DESIGN-2)

** C1 - MAIN CONTACTOR.

4.4 Design concept – 3 (Voltage sensing approach No – 1)

Here also reduce voltage is fed to primary winding and subsequently tried to developed control strategy by sensing terminal voltage at secondary winding. One step up power transformer with primary 5 VAC & secondary 24 VAC and one step down power transformer with primary 80 VAC & secondary 24 VAC were introduced to the system in order to provide sensing signals.

4.4.1 Operating procedure

Step – 1; initially main power feeding contactor is at de-energized state.

Step – 2; 24 VAC supply connect with primary winding of the welding transformer through auxiliary contacts (NC) of main power feeding contactor. Then subsequently 5 VAC output voltages generates at the out put terminals of secondary winding of welding transformer. This 5 VAC converted in to 24 VAC by the step up power transformer and subsequently resultant 24 VAC connects with control relay (having 24 VAC relay coil) through auxiliary contacts (NC) of main power feeding contactor. In order to increase the sensitivity used 5 VAC / 24 VAC step up transformer. So subjected control relay gets energized during idling and subsequently resultant signal feeds to the timer through “NC” contact of control relay.

Step – 3; If welder wants to start his welding operation normally he touches the welding electrode with the ground and subsequently terminal voltage of secondary winding of welding transformer drops and then above control relay gets de-energized and resultant signal sends to timer and subsequently timer gives signal to energize main power feeding contactor.

Step – 4; Then 400 VAC connects with primary winding of welding transformer.

Step – 5; Now welding transformer is ready for actual welding operation.

Step – 6; At this stage open circuit voltage at terminals of secondary winding of welding transformer is 80 VAC. This 80 VAC gets connect with step down power transformer with primary 80 VAC & secondary 24 VAC through the auxiliary contacts (NO) of main power feeding contactor. This resultant 24 VAC connects with same above control relay coil and subsequently it gets energized. Due to each actual welding operation above control relay gets de-energized and resultant signal feeds to timer and subsequently timer gets reset and shifts its time counting. That means along with each welding operation timer gets reset and shifts forward.

Step – 7; If above reset signal is failed to provide with in the set time period then timer gives signal to main power feeding contactor to de-energized and subsequently again 24 VAC supply connect with primary winding of the welding transformer through auxiliary contacts (NC) of main power feeding contactor.



Electronic Theses & Dissertations
www.lib.mrt.ac.lk

Step – 8; Now the system converts back to initial condition.

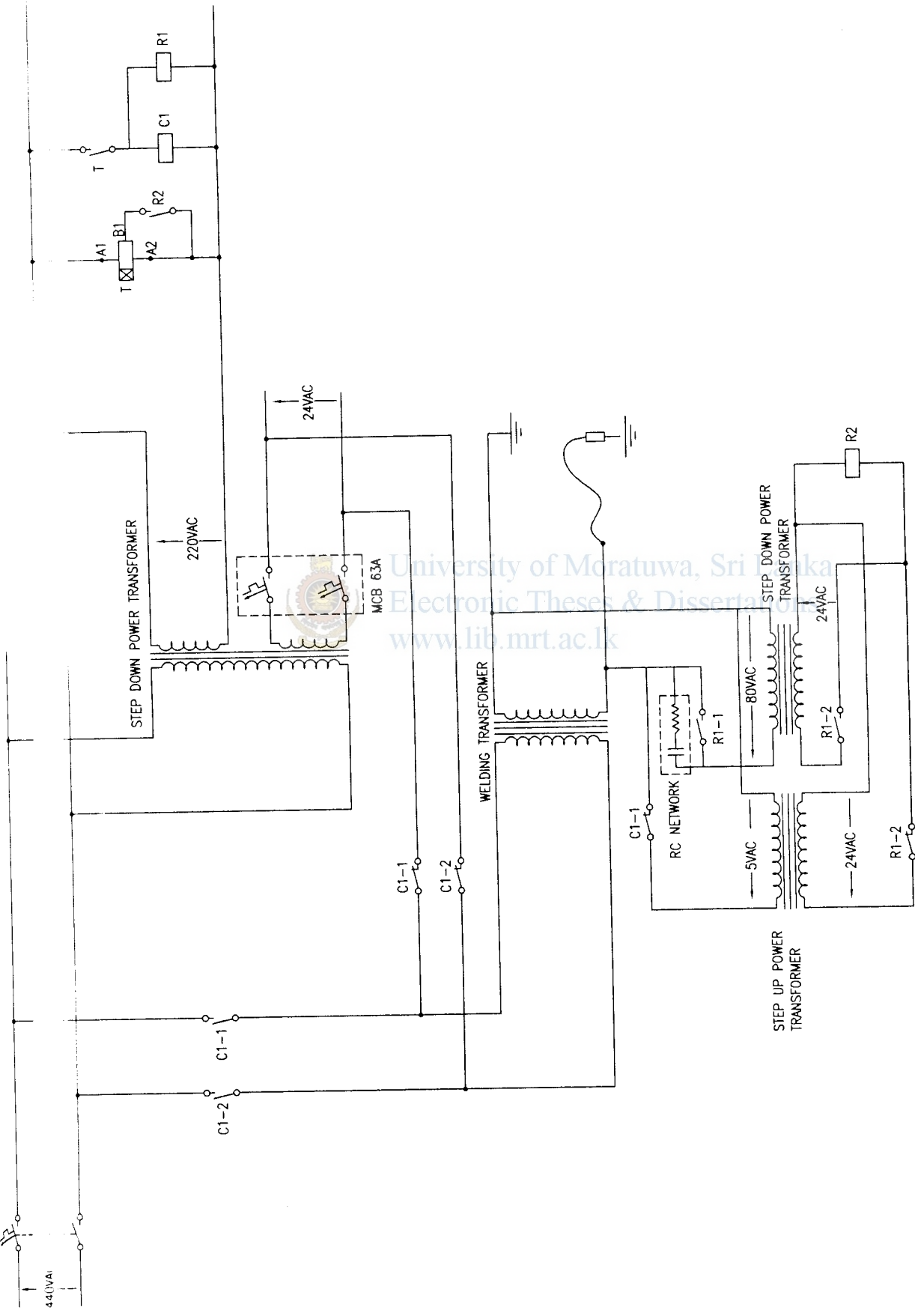

FIG.-4.2 CONTROL CIRCUIT FOR INDUSTRIAL WELDING TRANSFORMER TO ISOLATE PRIMARY WINDING FROM THE 440V AC MAIN SUPPLY DURING IDLING (DESIGN-3)

** C1-MAIN CONTACTOR.

4.5 Design concept – 4 {Final} , Voltage sensing approach No – 2

4.5.1 Difference between Design concept – 3 & Design concept – 4

Following is the only difference between Design concept – 3 & Design concept – 4

Hear avoided one above step down power transformer which having primary 80 VAC & secondary 24 VAC. Instead of above step down power transformer, hear introduced variable resister which is set at 575 Ω in order to cover all operating ranges.

During operation 400 VAC connects with primary winding of welding transformer and resultant 80 VAC generates by the secondary winding.

Above 80 VAC gets connect with above same control relay coil together with series variable resistance through the auxiliary contacts (NO) of main power feeding contactor. Resultant is again 24 VAC supply to control relay coil and rest 56 VCA drops through above variable resistance. Due to each actual welding oration above control relay gets de-energized and resultant signal feeds to timer and subsequently timer gets rest and shifts its time counting. That means along with each welding operation timer gets reset and shifts forward. Same procedure as Design concept – 3

Rest of all other steps of operation sequences are same as Design concept – 3

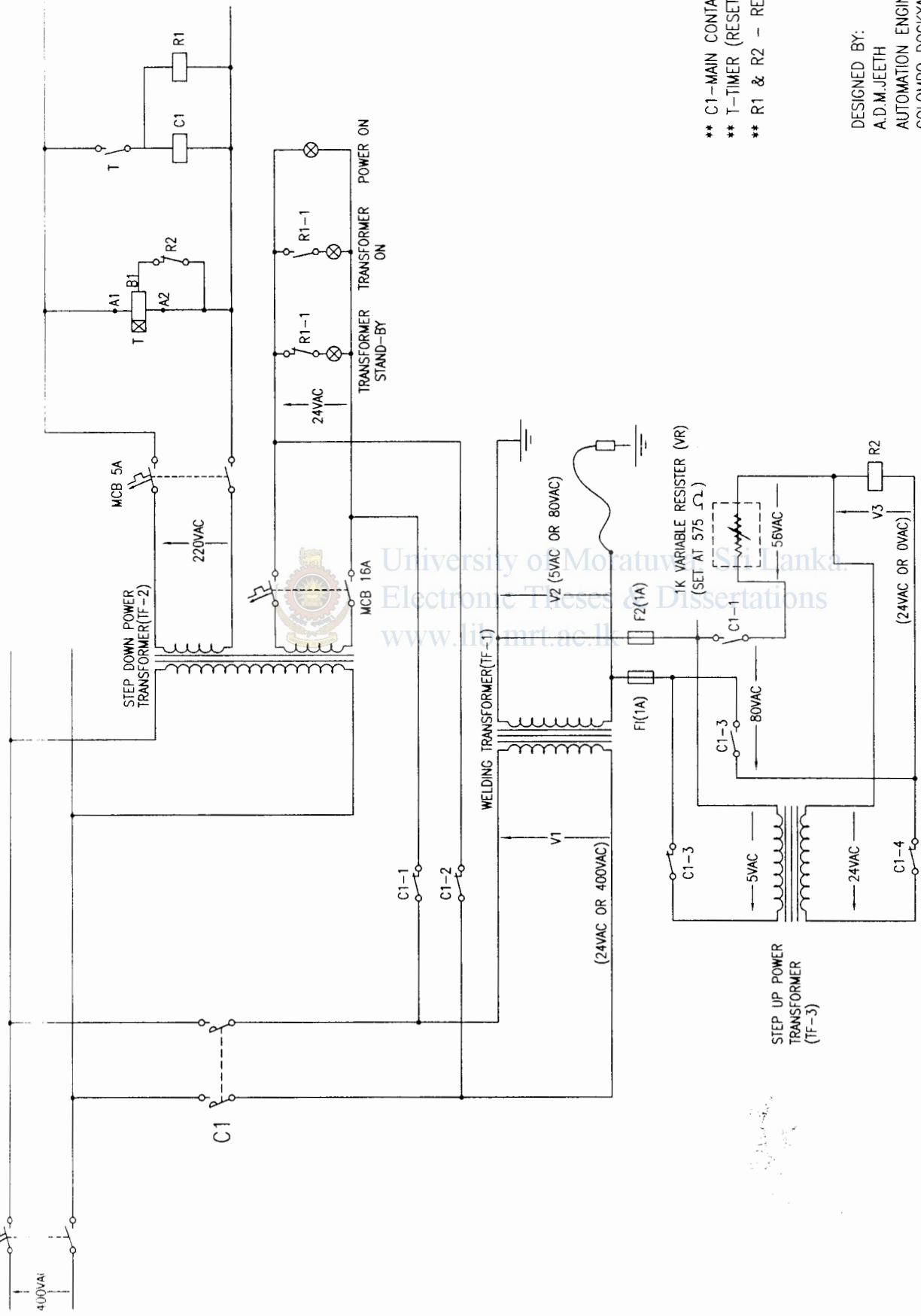

- ** C1 - MAIN CONTACTOR.
- ** T - TIMER (RESET TYPE).
- ** R1 & R2 - RELAYS.

DESIGNED BY:
 A.D.M.JEETH
 AUTOMATION ENGINEER
 COLOMBO DOCKYARD PLC.

FIG.-4.3 CONTROL CIRCUIT FOR INDUSTRIAL WELDING TRANSFORMER TO ISOLATE PRIMARY WINDING FROM THE 440V AC MAIN SUPPLY DURING IDLING (DESIGN-4)

4.5.2 Calculation of resistor value for Variable resistor which has used in control circuit.

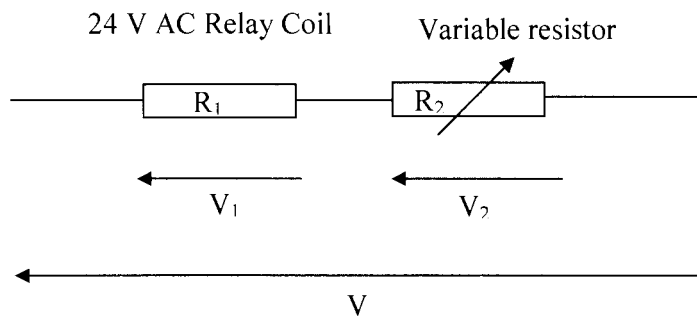

Figure 4.4 – Resistor arrangement to maintain required voltage across relay (R₁)

Specification of subjected relay (R₁) ;

Make: OMRON

Type : MY- 4

Rated supply coil voltage : 24 VAC.

Resistor value of relay coil : 156 Ω



University of Moratuwa, Sri Lanka.

Electronic Theses & Dissertations

lib.mrt.ac.lk

R₁ - Resistor value of 24 V AC relay coil = 156 Ω

R₂ - Resistor value of Variable resistor

V₁ - Voltage drop across R₁

V₂ - Voltage drop across R₂

V - Total voltage drop across R₁ & R₂

Open circuit voltage (during idling) across secondary winding terminals of welding transformer is vary from 68 V AC to 75 V AC depend on transformer current setting.

Short circuit voltage (during welding operation) across secondary winding terminals of welding transformer is vary from 23 V AC to 57 V AC depend on transformer current setting.

Minimum voltage (V) that can apply across both R1 & R₂ to energize relay during open circuit (when transformer in idling) = 68 V AC

Maximum voltage (V) that can apply across both R1 & R₂ to de-energize relay during short circuit (when transformer in operational) = 57 V AC

By measuring following characteristics were found for relay coil;

Minimum voltage to energized subjected relay = 16 V AC

Max voltage to de-energize relay = 10 V AC

Using ohms law [6] and doing repeated calculations for different values for R₁ found best value for **R₁ = 575 Ω** , in order to cover all above voltage ranges depends on all current settings.



University of Moratuwa, Sri Lanka.
Electronic Theses & Dissertations
www.lib.moratuwa.lk

4.6 Operation procedure according to the final design.

Operation Procedure;

(A) Initial condition:

1. C1 at de-energize condition
2. 24 VAC connects with the primary winding of welding transformer (TF-1) through the “NC” of C1
3. Out put voltage of secondary winding of welding transformer is around 5 VAC
4. Above 5 VAC connects with primary winding of step up transformer (TF-3) and it generates 24 VAC out put at the secondary winding of TF-1 and it connects with R2 (24 VAC relay) and R2 gets energized.
5. Reset signal for timer (T) gets open through “NC” contact of R2

(B) How it converts to running condition;

1. Once welding electrode touches with ground
2. R2 gets de-energize.
3. Reset signal for timer gives through “NC” contact of R2 and timer starts counting.
4. Timer gets energized and it gives signal to energize C1
5. 400 VAC connects with primary winding of welding transformer (TF-1) through the “NO” of C1
6. Now T/F is ready for welding operation
7. After connects 400 VAC with primary, out put voltage of secondary winding of welding transformer increases up to 80 VAC
8. Above 80 VAC connects with series combination of R2 & variable resistor (set at 575 Ω) and resultant 24 VAC out put connects with R2. Then R2 gets energize.
9. Again reset signal for timer (T) gets open through “NC” contact of R2
10. If welding operation performs (welding electrode touches with ground) above 80 VAC gets drops and R2 gets de-energize.
11. Reset signal generates for timer (T) and timer gets reset and starts counting.
12. Due to every welding operation timer gets rest and keeps on counting and shifts forward.
13. If it fails to generate next reset signal for timer within the set time (3 minutes) that means no welding performs, then T gets de-energized. C1 also de-energized. Again 24 VAC connects with the primary winding of welding transformer. Transformer at idle condition and converts it to initial condition.

4.7 Functional block diagram according to the final design.

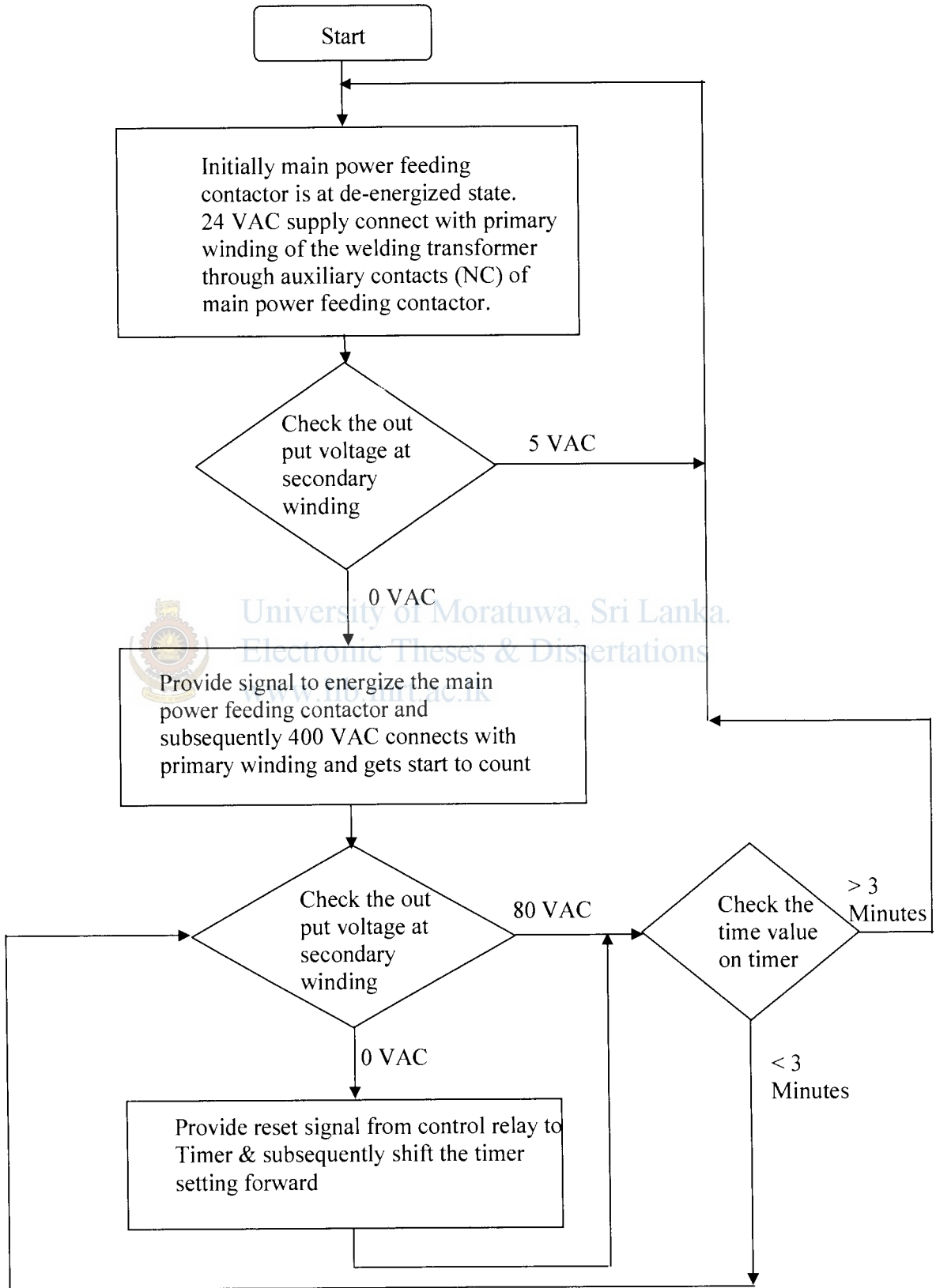

Figure 4.5 - Functional block diagram according to the final design.

Chapter 5

Energy saving calculations and cost benefit analysis.

5.1 Material used for control circuit and their cost

Materials for proposed control circuit				
Item No	Description	Qty	Unit price Rs.	Total price Rs.
1	Timer with reset facility, supply : 220 VAC	1 No	3,000.00	3,000.00
2	Magnetic contactor, supply 230 VAC coil ,2 Pole	1 No	6,000.00	5,000.00
3	Control relay MY-2, 24 VAC	1 No	250.00	250.00
4	Control Relay , 220 VAC Coil voltage , 2 Pole	1 No	350.00	350.00
5	Step down power transformer, Primary 400 VAC & Second 24 VAC , 230 VAC	1 No	700.00	700.00
6	Step up power transformer, Primary 5 VAC & Second 24 VAC	1 No	500.00	500.00
7	Variable resister, 1K	1 No	40.00	40.00
8	Powder coated weather proof metal enclosure Size: 400 x 300 x 150 mm	1 No	1,325.00	1,325.00
Total				Rs.11,165.00

Table 5.1 – Material list for one unit with their prices

5.2 Measuring of actual active power consumption of welding T/F when idling with out implementing new system

It was measured by using active power energy meter.

Specifications of used energy meter as follows.

Specifications of the used energy meter:

Make : Polyphase Energy meter

Time	Reading on energy meter (kWh)
08.30 Hours	2.54
13.53 Hours	6.55
18.48 Hours	10.96

Table 5.2 - Measured data about active power consumption of welding T/F when idling with out implementing new system

As per above table active power consumption for 10.5 hours = $10.96 - 2.54 = 8.42$ kWh

5.3 Energy saving calculation [7]

During general steel fabrication operation, If transformer uses for average 10 hours per day generally it will idle around 6 hours (60 %) . as per the measurement taken as mentioned under chapter 4.6.4

Power loss during above idling 6 hours [8] = $(8.42 \text{ kWh} / 10.5 \text{ hours}) \times 6 \text{ hours} = 4.81 \text{ kWh}$

For one T/F power loss per day = 4.5 kWh

Total No of T/F in yard in operational = 685 Nos

Total power loss per day for all transformer units = $685 \times 4.5 = 3082.5 \text{ kWh}$

Total loss = 3082 Units

CEB average charge per unit = Rs. 7.00

Total loss per day = $3082 \times 7 = \text{Rs. } 21,574.00$

Say No of working days per month: 25 days

Total No of working days per year = 300 days

Average annual loss for all 685 Nos of transformers = $300 \times 21,574.00 = \text{Rs. } 6,472,200.00$

5.4 Calculation of simple pay back period [7]

Average annual loss = $300 \times 21,574.00 = \text{Rs. } 6,472,200.00$

Total material cost to make one control unit for one unit = Rs. 11,165.00

Total No of T/F in yard in operational = 685 Nos

Total material cost for all 685 Nos of units = Rs. 7,648,025.00

Simple pay back period = $\text{Rs. } 7,648,025.00 / \text{Rs. } 6,472,200.00 = 1.2 \text{ years}$

5.5 Comparison between active power consumption of welding T/F when idling with & with out implementing new system for one machine.

Time	Reading on energy meter (kWh) with out implementing new system	Reading on energy meter (kWh) with implementing new system
08.30 Hours	2.54	10.960
13.53 Hours	6.55	11.183
18.48 Hours	10.96	11.407

Table 5.3 – Reading observed from energy meter

Time	Reading on energy meter (kWh) with out implementing new system	Reading on energy meter (kWh) with implementing new system
08.30 Hours	0.00	0.000
13.53 Hours	4.01	0.223
18.48 Hours	8.42	0.447

Table 5.4 – Actual energy consumption after deducting initial meter reading.

Summary

Before implementing new system active power consumption for 10.5 hours =
 $10.96 - 2.54 = 8.42 \text{ kWh}$

After implementing new system active power consumption for 10.5 hours =
 $11.407 - 10.960 = 0.447 \text{ kWh}$

Power saving for 10.5 hours, between new and old conventional system =
 $8.420 - 0.447 = 7.973 \text{ kWh}$

Chapter 6

Conclusion

New system was practically implemented and tested for long period of time in different work conditions in Colombo Dockyard PLC with existing conventional welders but no behavioral changes were observed after implementing new system. Key point is during designing made special attention not to change existing conventional welding procedure and not to introduce additional external sensors and cables other than conventional welding electrode and cable. After implementing proposed system for all welding transformers in yard it will be a great economical benefit to yard and by saving energy it will be a solution and benefit to existing power crisis of Sri Lanka. Even it can manufacture and sell as a commercial product.

Voltage sensing boards [9], which are currently available in market, can be used in order to sense voltage levels at the output terminals of secondary winding. Subsequently can produce signals for control system. But only problem is those voltage sensing board are very expensive. And difficult to use those in rugged environment, like ship building industry. So suggested design is very cheap and it can use and already proved its operation in rugged environment.

References:

- [1] <http://www.esabindia.com/>, Official WEB of ESAB India.
- [2] http://www.indiamart.com/ardentengineers/pcat-docs/standard-arc-equipment_10679914.pdf, OEM Specifications of air cooled arc welding transformer Make: ESAB India Limited Kolkata, Model: Transweld 400.
- [3] <http://www.sail.co.in/IPSS/1-07-001-95.pdf> , INTER PLANT STANDARD – STEEL INDUSTRY, SPECIFICATIONS FOR ARC WELDING TRANSFORMERS (THIRD REVISION).
- [4] User Manual of subjected arc welding transformer,
Make: ESAB India Limited Kolkata, Model: Transweld 400.
- [5] User Manual of Fluke Scope Meter 105 B Series II, 0/1-Mar-1996.
- [6] http://www.physics.ncsu.edu/courses/pylabs/212/docs/212_OhmsLaw.pdf, Ohms Law and Combinations of Resistors, PY 212.
- [7] Moncef Krarti, “ENERGY AUDIT OF BUILDING SYSTEMS, An Engineering Approach, October 2000.
- [8] http://en.wikipedia.org/wiki/AC_power, Calculation of AC Power.
- [9] http://www.rossengineeringcorp.com/voltage_level_sensor.htm , ROSS ENGINEERING CORPORATION, VOTAGE LEVEL SENSOR/INTERLOCK CIRCUITS AND MODULES.

APPENDIX – A: Sample screen shots during study of operator’s work pattern from FLUKE SCOPE meter

A.1 Sample screen shots

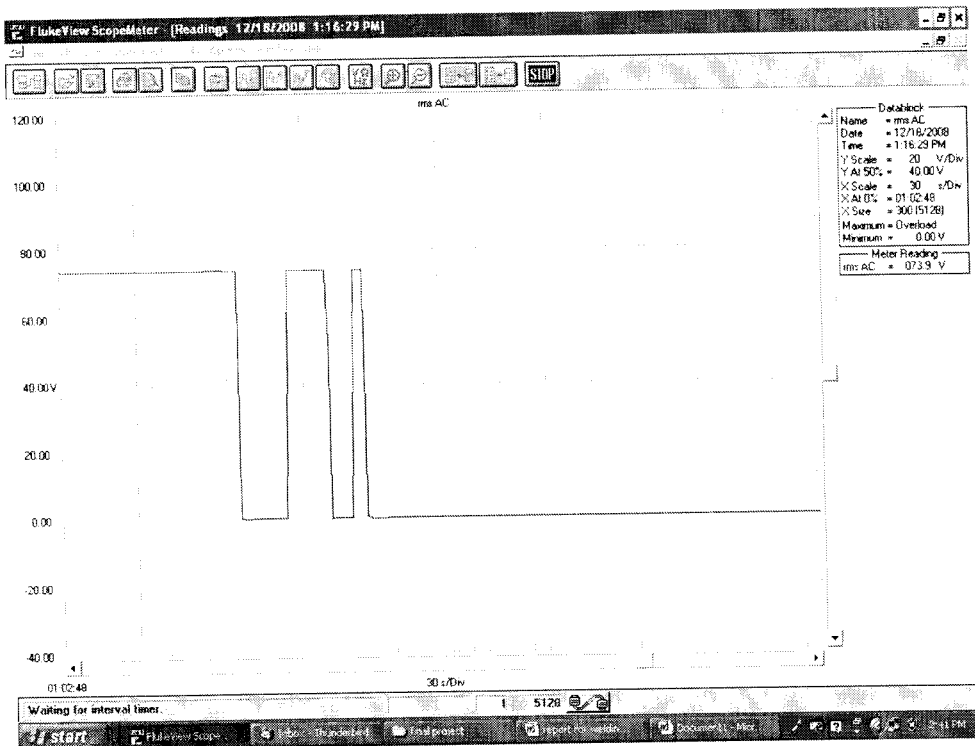
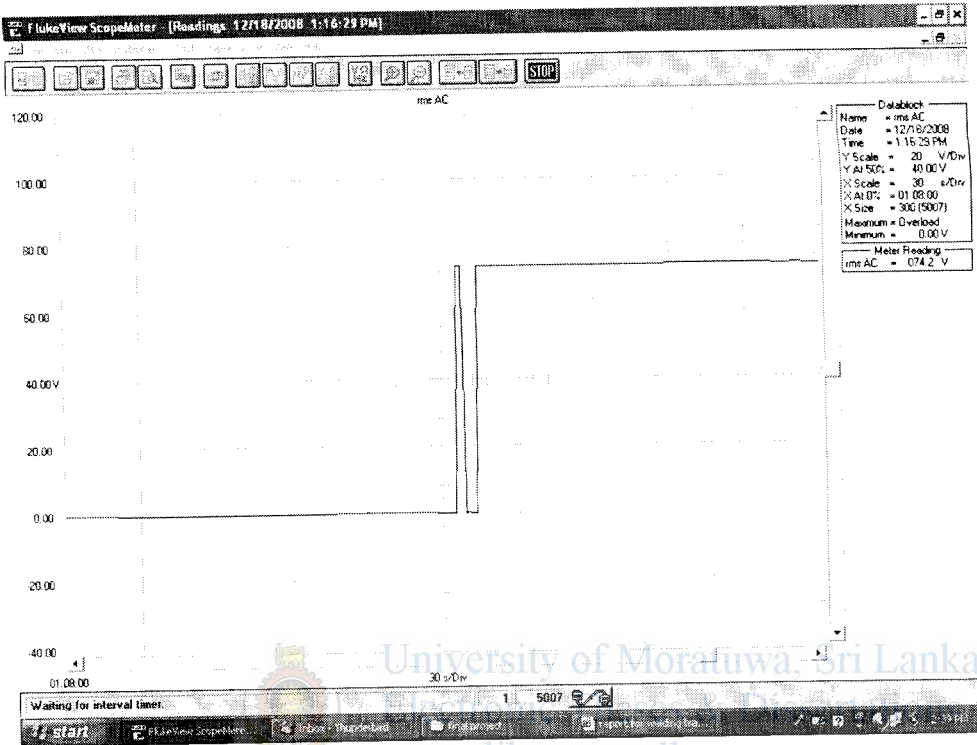

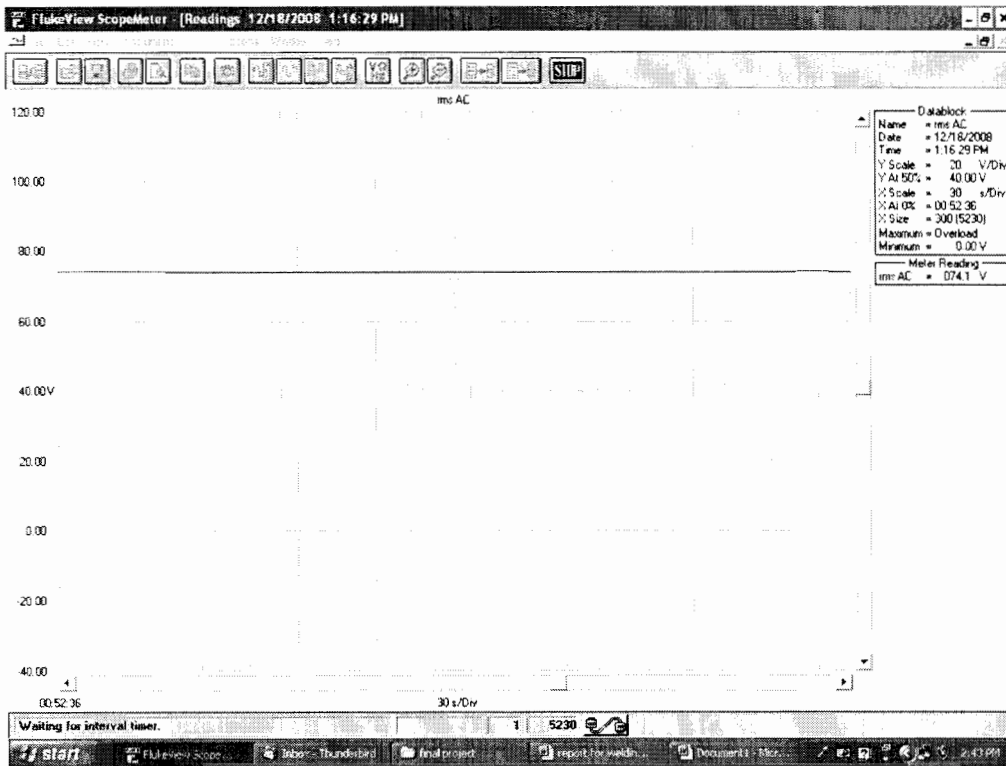

University of Moratuwa, Sri Lanka.

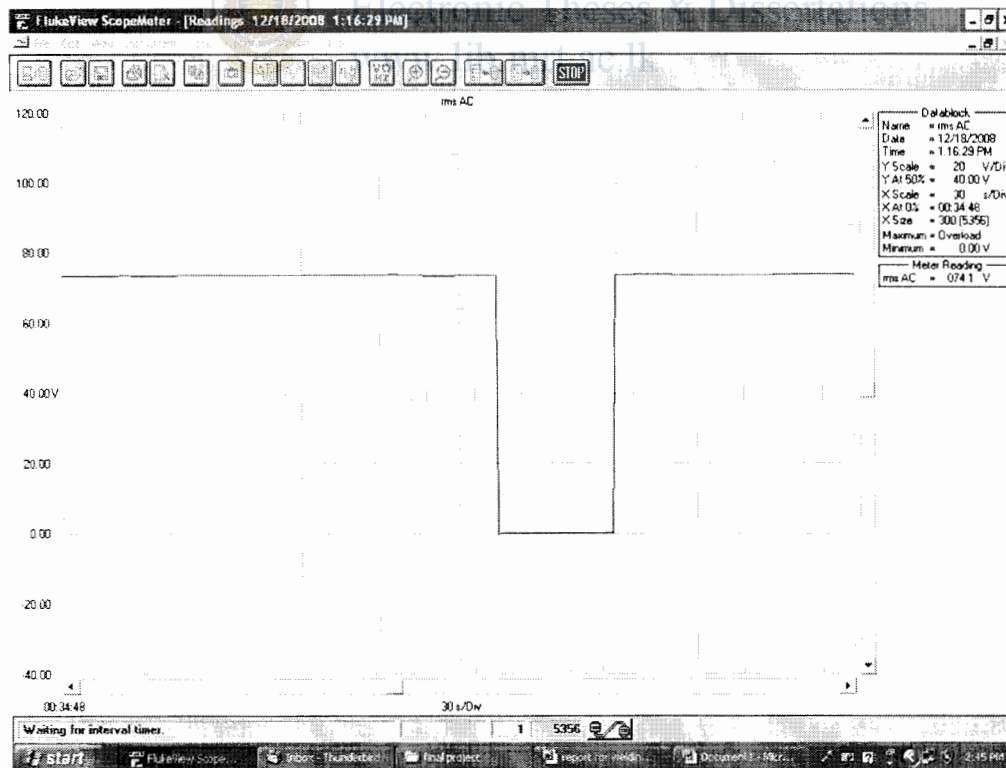

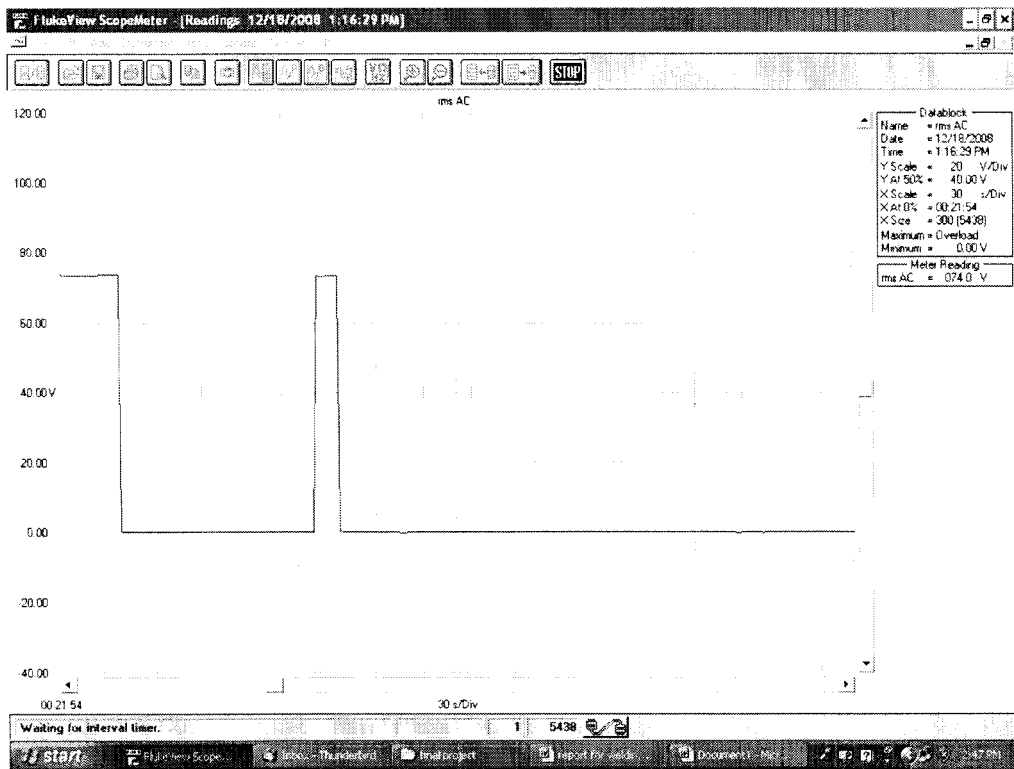

University of Moratuwa, Sri Lanka
Electronic Theses & Dissertations
www.mru.ac.lk

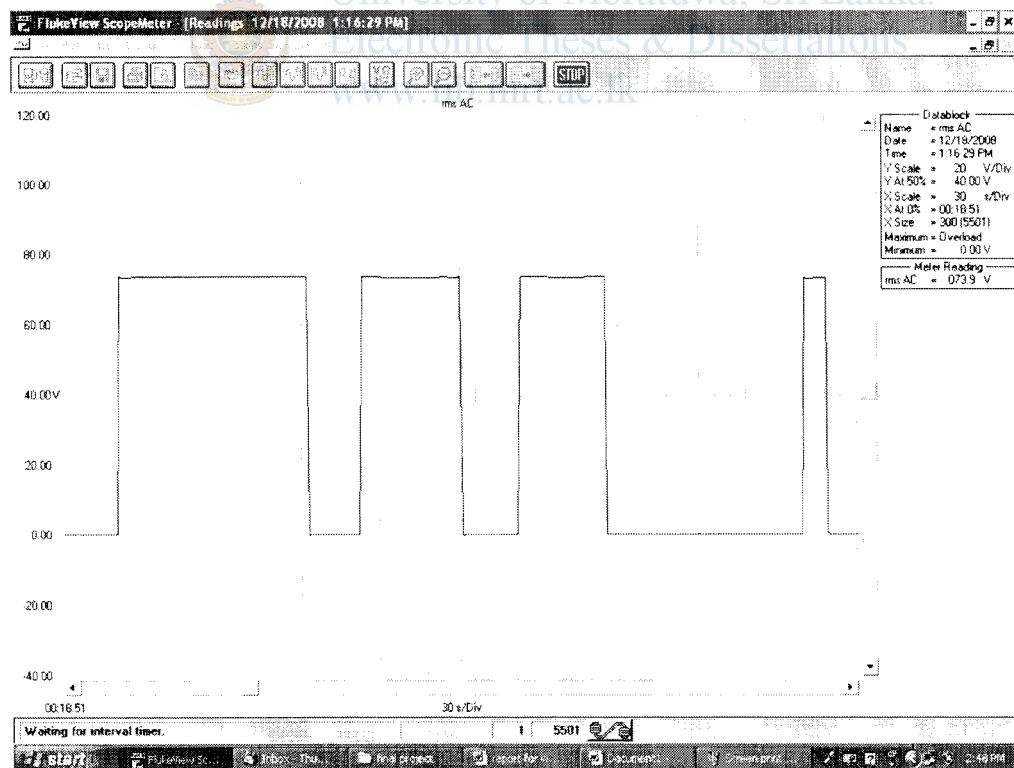

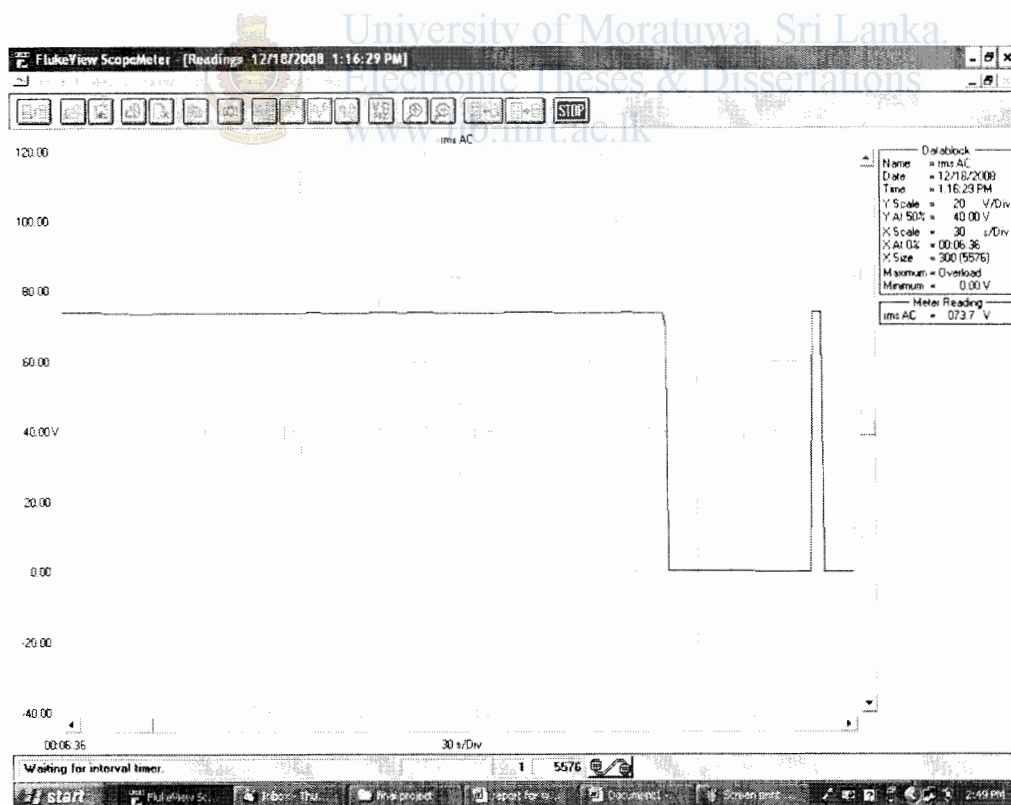
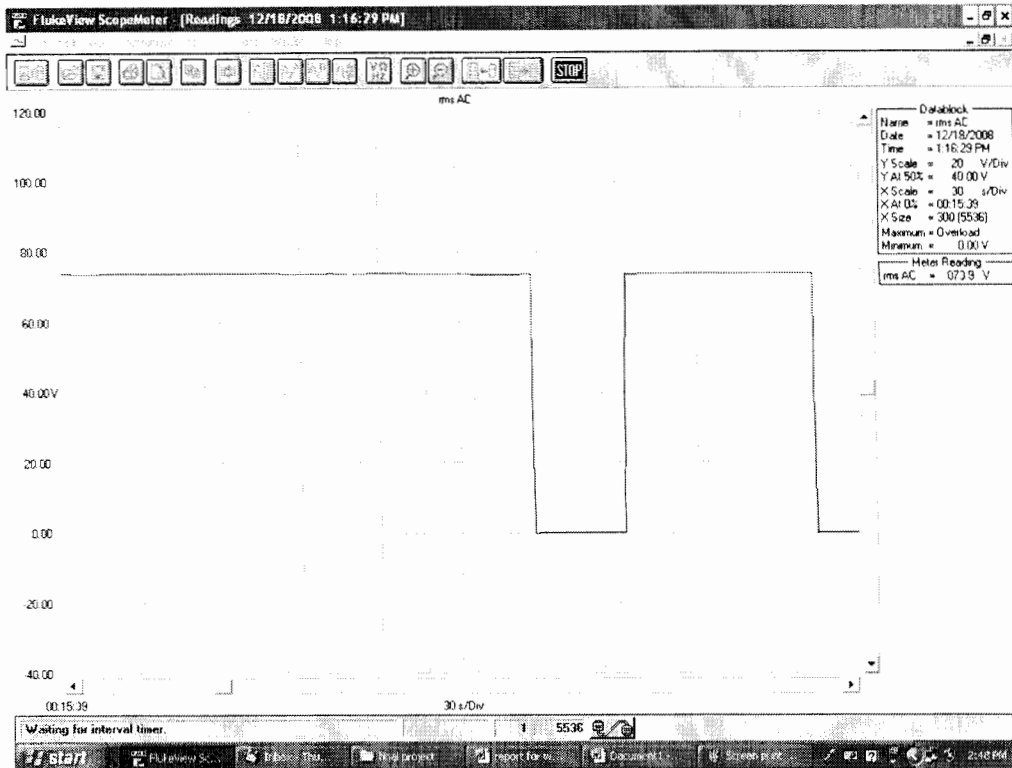

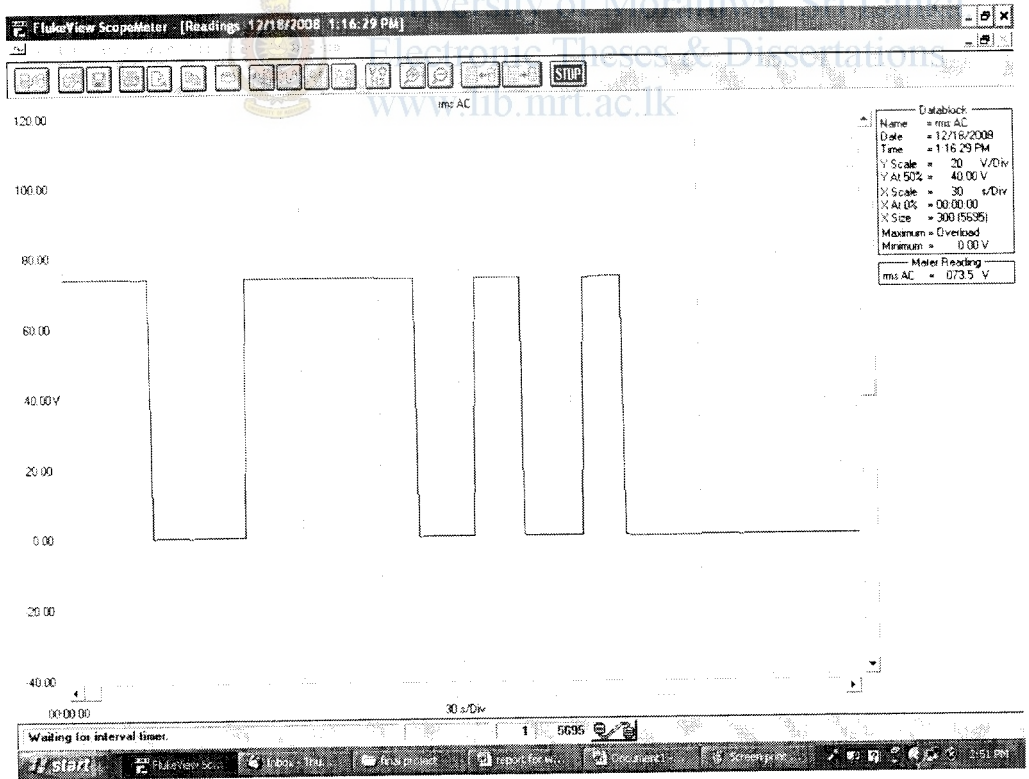
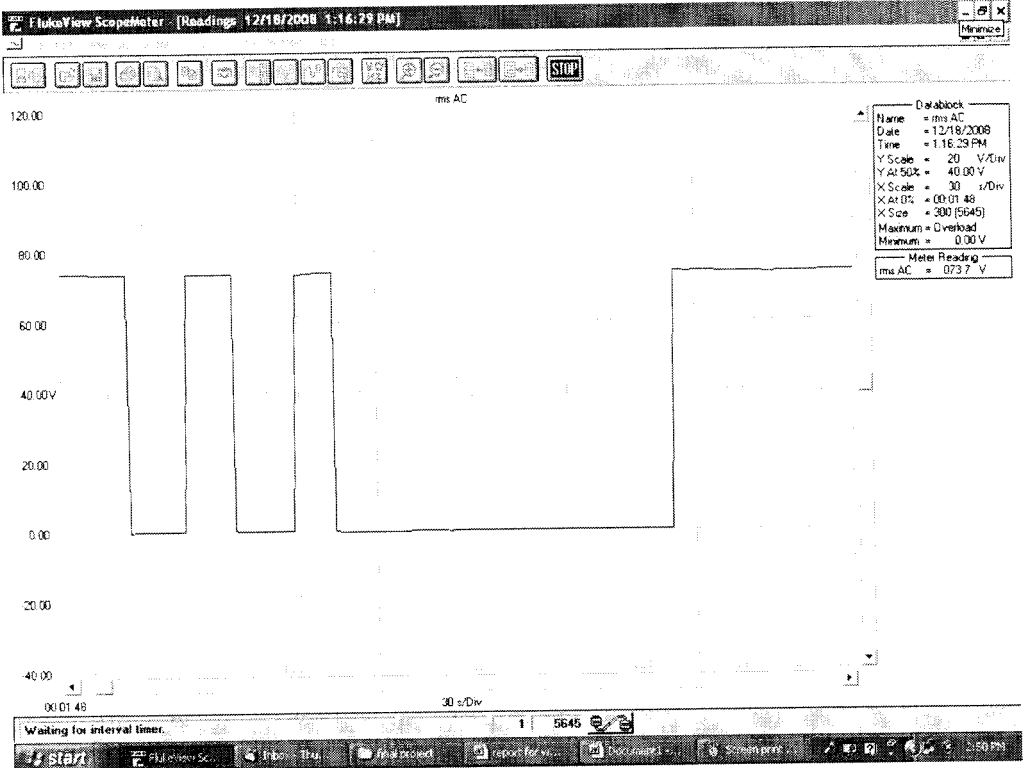

APPENDIX – B: Literature about instrument and equipments which were used

B.1 Attached following are some literature about instrument and equipments which were used during my project.

1. Timer
2. Current sensing relay
3. Current Transformers (CT)
4. Information about SCOPE Meter which was used for data logging.
5. Information about voltage sensing available in market [9]



University of Moratuwa, Sri Lanka.
Electronic Theses & Dissertations
www.lib.mrt.ac.lk

Products

- ▼
Electronics
- ▼
Reclamation Consumables
- ▼
Arc Equipment
- ▼
Industrial Gas Equipment
- ▼
Environment Products
- ▼
Cutting Systems

Transweld 400 - Air cooled welding transformer

ESAB Transweld 400 is a 400 Amp Manual Arc Welding Transformer that combines unique functional and safety features. Ensures excellent welding quality with economy. Its natural air-cooled ensures non-stop performance even in the most uncertain difficult conditions. Ideal for use at site or in a workshop.



Special Features

- Natural air cooled machine ensures maximum safety
- Current available in single range. Current indicator and current control handle both on front panel
- Robust and compact construction ability to withstand rough handling at sites
- Horizontal shunt core travel ensures precise setting after prolonged use
- Class 'H' insulation provides longer coil life

Ordering No.

461-0641-400

Technical Specifications

Input

Supply Voltage	415V, 2 Lines of 3 Phases, 50Hz AC
Rated Input Current	63 Amps
Rated Input KVA	26 KVA

Output

Open Circuit Voltage (Maximum)	80 V
Range of Welding Current	80 - 400 Amps
Maximum Continuous Hand Welding current at 60% duty cycle (Rated welding current)	300 Amps
Type of welding current regulation	Stepless
Type of cooling	Natural Air Cooled
Net Weight (Approx).	115 Kgs
Approx. Dimension	600 x 410 x 720 mm

Specification about current control relay that has used

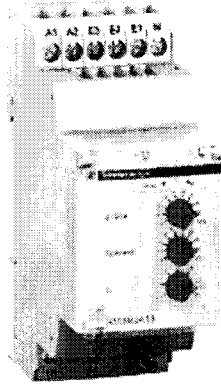

University of Moratuwa, Sri Lanka.
Electronic Theses & Dissertations
www.lib.mrt.ac.lk

Current control relay RM35JA32MW [RM35JA32MW]

Description: Current control relay RM35JA32MW

Supply voltage: 24....240V AC/DC

Time delay: 0.3....30s

Output: 2C/O 5A

Control rating: 0.15....15A

Function: Under & Overcurrent

Width: 35mm

(1) 1 A fast-acting fuse, UL...Class CC : IEC...gG
 Fusible rapide 1 A. UL...Classe CC : IEC...gG
 Schnellsicherung 1 A. UL...Klasse CC : IEC...gG
 Fusibile rápido 1 A. UL...Clase CC : IEC...gG
 Fusibile rapido 1 A. Omologato UL...Classe CC : IEC...gG

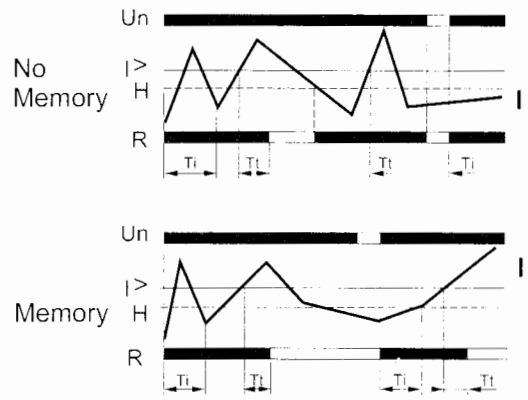
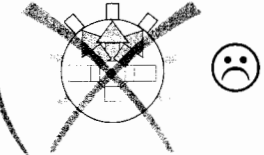
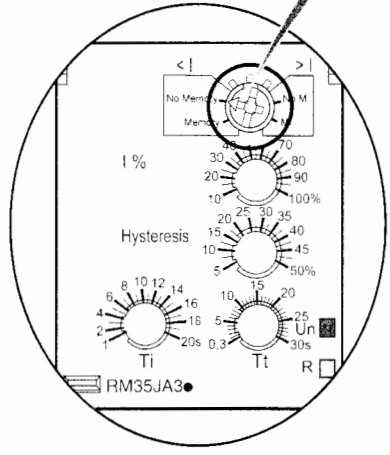
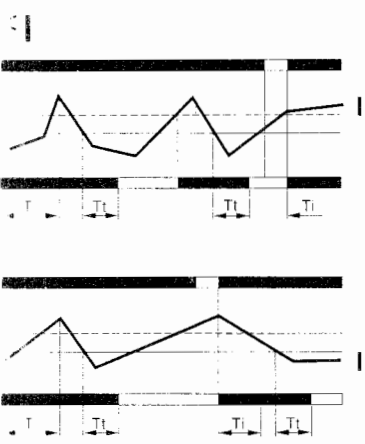
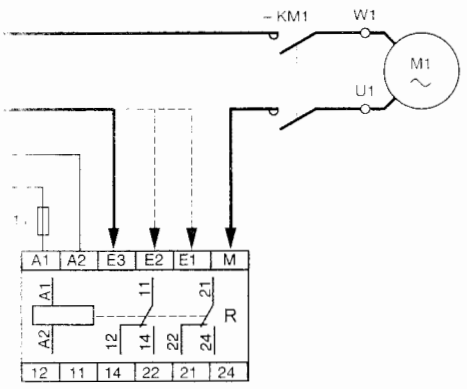

Delay upon startup (adjustable on front panel) / T_i : temporisation d'inhibition au démarrage (réglable en façade)
 Wirkungsverzögerung (an Frontseite einstellbar) / T_i : temporización de inhibición en el arranque (ajustable en fachada)
 Inibizione all'avviamento (regolabile sul pannello anteriore)
 Opening, after threshold overshoot (adjustable on front panel) / T_t : temporisation à l'ouverture après franchissement du seuil (réglable en façade)
 Öffnen nach Überschreitung des Grenzwerts (an Frontseite einstellbar) / T_t : temporización en la apertura luego del paso de umbral (ajustable en fachada)
 Apertura dopo il superamento della soglia (regolabile sul pannello anteriore)

Erloschen / Apagado / Spenta ☹ On / Allumée / Brennt / Encendido / Accesa ☹ Blinking/ Cignotante / Blinkt / Intermitente / Lampeggiante

OFF		R
ON > < ☺		12/22 14/24 11/21
ON < < ⌚ T_t (1) ☹		12/22 14/24 11/21
ON < < ⌚ T_t (2)		12/22 14/24 11/21
ON < < ⌚ T_t (2)		12/22 14/24 11/21
ON > <		12/22 14/24 11/21

Un ☹ R ☹ OFF		R
☺ ON < > ☹		12/22 14/24 11/21
☺ ON > > ⌚ T_t (1) ☹		12/22 14/24 11/21
☺ ON > > ⌚ T_t (2)		12/22 14/24 11/21
Un ☺ R ☹ ON > > ⌚ T_t (2)		12/22 14/24 11/21
☺ ON < >		12/22 14/24 11/21

reset time delay (adjustable on front panel) / Fin de la consigne de temporisation (réglable en façade) / Ende des Sollwerts der Verzögerung (an Frontseite einstellbar) / Fin de la consigna de temporización (ajustable en fachada) / Fine dell'istruzione di temporizzazione (regolabile sul pannello anteriore)

TIMED MULTIFUNCTION, MULTI-VOLTAGE OR SINGLE-VOLTAGE RELAY - 1 DIN with backlit display

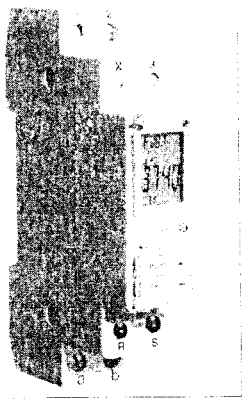

1 - Technical specifications

Model	Supply	Type of output	Maximum power	
			AC	DC
Multivoltage	11 ± 253 V AC/DC	Relay with changeover contact voltage-free	16A 250 VAC (Cosφ = 1)	16A 250 VDC (I/R = 0 ms)
230V	230 V AC ± 10 %		AC15 N.O. 5A 240VAC	DC13 N.O. 2.5A 24VDC (50 ms)
110V	110 V AC ± 10 %			
48V	48 V AC/DC ± 10 %		N.C. 1.5A 240VAC	
24V	24 V AC/DC ± 10 %			
12V	12 V AC/DC ± 10 %			

Nominal frequency: 50 - 60 Hz
 Protection degree: IP 40 (DIN rail) IP 30 (Wall mount)
 Installation: DIN rail - Wall mount (with optional terminal cover)
 Time setting range: 0.1 s - 99 h 59 m
 Maximum wire section at terminals: 1 mm² - 2.5 mm²
 Minimum pulse duration: 50 ms
 Recovery time: ≤ 100 ms
 Voltage for insulation test: 2.5 KV / m
 Operating temperature limits: -5 - +50 °C
 Storing temperature limits: -25 - +65 °C
 Reference standard for CE mark (directives): 73/23/CEE - 89/330/CEE
 EMC: EN 61812-1 application class 1



ENGLISH

1121001 - 01/03

Description, front view and display

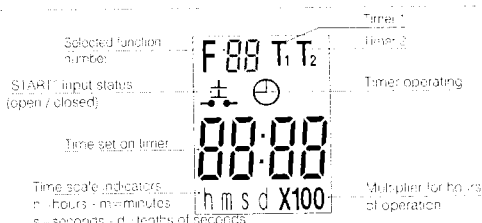
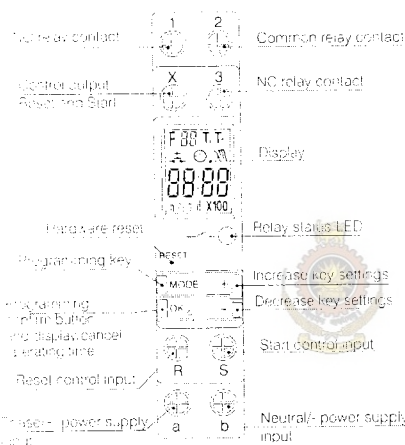

Important: the installation and electrical connections of devices and equipment must be performed by qualified personnel in conformity with current standards and regulations. The manufacturer does not assume any responsibility concerning the use of the products, which must conform to particular environmental and/or installation standards.

2 - ELECTRICAL CONNECTIONS

- switch mains supply off
- connect the power supply, depending on the model, to terminals **a** and **b**
- connect the interlocked device to terminals 1 - 2 - 3
- 1 - Normally open contact 2 - Common 3 - Normally closed contact
- **START** and **RESET** buttons can be connected to terminals **R, X, S**

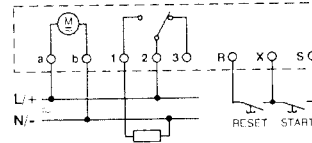

WARNING: in case of particularly reactive loads or or with a cos φ value lower than indicated in the technical data, the relay could suffer damage. It is advisable in such instances to use a suitably rated external or screw-down switch.

NOTE: in these instructions the following convention is used

88 permanently alight
 88 blinking

3 - PROGRAMMING

FUNCTION SELECTION

When first switched on (no configuration set), the device does a test cycle (lamp test) and automatically goes to the **Function Selection** phase. F01 flashes on the display and T1 fixed.



use + or - keys to select the desired function. For each function, the timers activated are indicated by lighting up of indicators T1 and T2 and the symbol of the type of START (external symbol or) see CHAP. 9 FUNCTIONS

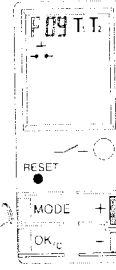

TIME SCALE

Once selection is made, confirm with **OK** to go to **Time Scale** selection (the display shows the function e.g. F09.T1, fixed the time scale indicators flash)



N.B. To modify the previous configurations see CHAP. 4 ACTIVATION OF PROGRAMMING CYCLE TO CHANGE SETTINGS

According to the timing required, the most suitable scale (hours, minutes, etc.) can be selected with the programmable intervals given in the table. Press the **MODE** key to go from one scale to the next.



Scale	Adjustable Interval	
h	hours	from 1 to 99 hours
hm	hours+minutes	from 0 h and 1 m to 99 h and 59 m
m	minutes	from 1 to 59 minutes
ms	minutes+seconds	from 0 m and 1 s to 59 m and 59 s
s	seconds	from 1 to 59 seconds
sd	seconds + tenths	from 0 s and 1 tenth to 59 s and 9 tenths
d	tenths of seconds	from 1 to 9 tenths

TIMER SETTING

Once selection is made, press **OK** to confirm and go to **timer Setting**. The display shows the selected Function, the Timer on which the setting is being made and the time scale indicators (the central figures flash)



电流互感器 CURRENT TRANSFORMER

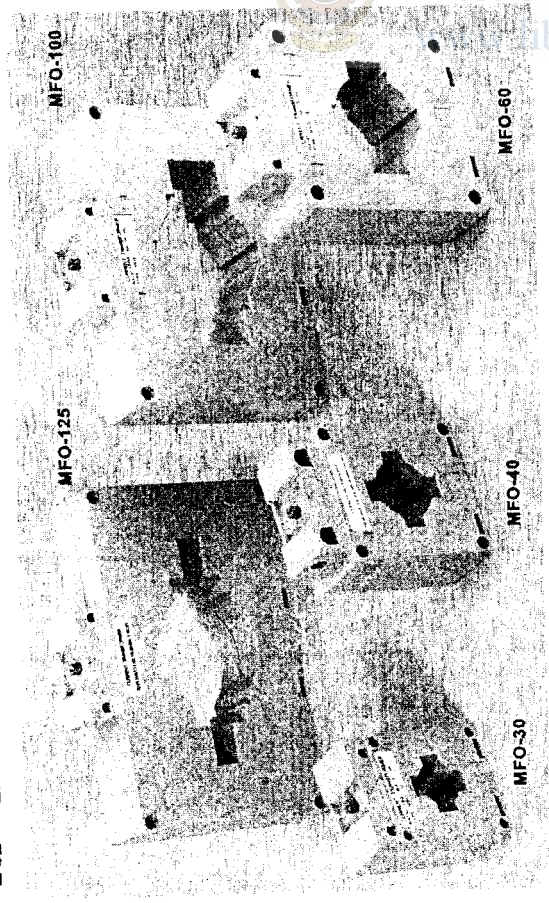

技术说明 Specifications

型号 Model	额定电流(A) Primary/Secondary	精度 Accuracy	额定电压 (V) Rated Voltage (V)	额定容量 Rated burden(VA)	精度 Accuracy	额定电压 (V) Rated Voltage (V)	额定频率 Rated Frequency (Hz)
MFO-30CT	30/5A-300/5A	3.0-0.5	600	1.5-5	3.0-0.5	600	50/60
MFO-40CT	40/5A-400/5A	1.0-0.5	600	5-10	1.0-0.5	600	50/60
MFO-60CT	60/5A-600/5A	1.0-0.5	600	5-10	1.0-0.5	600	50/60
MFO-100CT	100/5A-1000/5A	1.0-0.5	600	15	1.0-0.5	600	50/60
MFO-125CT	125/5A-1250/5A	1.0-0.5	600	15	1.0-0.5	600	50/60

尺寸说明 Dimensions

型号 Model	单位 Unit:mm						
	A	B	C	D	E	F	G
MFO-30(Small)	60	36	67	17	60	31	10
MFO-30CT	75	43	82	17	60	31	10
MFO-40CT	75	43	82	17	60	31	10
MFO-60CT	101	44	111	17	60	31	10
MFO-100CT	145	45	139	17	60	31	10
MFO-125CT	196	46	210	17	60	34	11

外形尺寸 Outline drawing

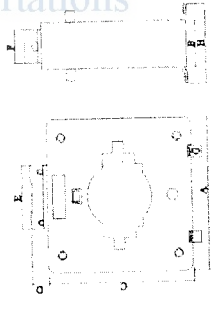

RCT Series.

- 一次电流 Primary current: 30A-30000A
- 二次电流 Secondary current: 5A, 1A
- 标准册代号 Standard approval: IEC44-1
- 最大电压 Maximum voltage: 0.66KV
- 频率 Frequency: 50-60Hz
- 额定负载 Rated load: 15VA
- 精度等级 Class: 1.0
- 短时热电流 Short-time thermal current: Ith=60XIn
- 额定安全系数 Rated security coefficient: FS=5

Specification:

型号 Model	规格 Primary/secondary	
RCT-25	15/5A	20/5 30/5 40/5 50/5 60/5 75/5 100/5
RCT-35	30/5 50/5 60/5 80/5 100/5 120/5 150/5 200/5 250/5 300/5	
RCT-60	300/5 400/5 500/5 600/5 800/5 1000/5 1200/5	
RCT-90	800/5 1000/5 1200/5 1500/5 1600/5	
RCT-110	1000/5 1200/5 1500/5 1600/5 2000/5 2500/5 3000/5	

外形尺寸 Dimensions(mm):

Model	RCT-25	RCT-35	RCT-60	RCT-90	RCT-110
A	93	93	93	93	102
B	78	78	78	78	86
C	25	32	60	90	111
D	78	78	104	136	157
E	2	2	2	2	2
F	55	55	41	41	53
G	9	9	9	9	9

结构图 Outline Drawing:

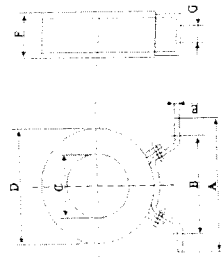

30/5
100/5

Fluke 92B/96B/99B/105B Series II ScopeMeter®

Users Manual

0/1-Mar-1996

© 1996 Fluke Corporation. All rights reserved. Printed in the Netherlands.

All product names are trademarks of their respective companies.

Electronic Workshop, Colombo Dockyard Ltd. 10.04.97

FLUKE®



ROSS ENGINEERING CORPORATION

Company

Products

Services

Contacts

International

VOLTAGE LEVEL SENSOR

Up

B-10

Standard Model

Deluxe Model

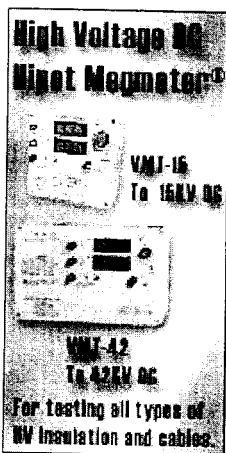

VOLTAGE LEVEL SENSOR / INTERLOCK

Useful for Power Supply Voltage Limiter, Capacitor Charge Level and, under or over Voltage Control, or Indicating.

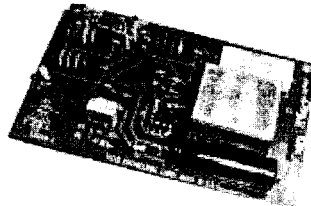

Ross Engineering Corporation will custom build you voltage level sensor / indicator / interlock from our building blocks.

Description

For limiting, setting or indicating voltage levels of pc supplies, required charge level for energy storage capacitors, and voltage level interlocking.

Some of the many options available are:

- High accuracy adjustable trip point.
- High sensor input impedance for internal line or external sensing.
- Extremely fast response or adjustable delay.
- Voltage level sensor can be powered from your AC line or DC source, 5 to 150V DC (If DC source voltage being sensed it must have a common connection), actuate from voltage whose level is being sensed (requires at 0.01 ampere for trip). Can have isolated trip input.
- Voltage level sensor can have transient protection installed.
- AC or positive, zero or negative voltage level can be sensed.
- Voltage levels to ± 750 volts can be sensed using resistors mounted internally on printed circuit board.
- Voltage levels greater than ± 750 volts can be sensed using external voltage dividers.
- Voltage levels less than ± 1 microvolt can be sensed under optimum conditions.
- Fixed trip point can be built into voltage level sensor.
- External resistor, or a trimmer potentiometer, or a remote conventional potentiometer may be used to set variable trip point.



University of Moratuwa, Sri Lanka.

Electronic Files & Dissertations

www.lib.mrt.ac.lk