

**MITIGATION OF IMPACTS OF LIGHTNING SURGES
ON LOW VOLTAGE SIDE OF POWER DISTRIBUTION
SUBSTATIONS**

K.H.G.S. Jayaneth

128869D

Degree of Master of Science in Electrical Engineering

Department of Electrical Engineering

University of Moratuwa

Sri Lanka

December 2016

**MITIGATION OF IMPACTS OF LIGHTNING SURGES
ON LOW VOLTAGE SIDE OF POWER DISTRIBUTION
SUBSTATIONS**

K.H.G.S. Jayaneth

128869D

Dissertation submitted in partial fulfillment of the requirements for the
Degree of Master of Science in Electrical Engineering

Department of Electrical Engineering
University of Moratuwa
Sri Lanka

December 2016

DECLARATION OF THE CANDIDATE AND SUPERVISORS

“I declare that this is my own work and this dissertation does not incorporate without acknowledgement any material previously submitted for a Degree or Diploma in any other University or institute of higher learning and to the best of my knowledge and belief it does not contain any material previously published or written by another person except where the acknowledgement is made in the text.

Also, I hereby grant to University of Moratuwa the non-exclusive right to reproduce and distribute my dissertation, in whole or in part in print, electronic or other medium. I retain the right to use this content in whole or part in future works (such as articles or books).

.....

Signature

(K.H.G.S. Jayaneth)

.....

Date

The above candidate has carried out research for the Masters Dissertation under my supervision.

.....

Signature of the supervisor

(Prof. J.R. Lucas)

.....

Date

ACKNOWLEDGEMENTS

First of all, my gratitude is towards my supervisor, Professor J. R. Lucas, who guided me throughout my research work, in spite of his busy schedules.

Also, I would like to extend my gratitude to all the lecturers of Electrical Engineering Department, University of Moratuwa for the guidance provided by them to improve my research, with their valuable comments.

My gratitude also given towards former Deputy General Manager Eng. K.M.K. Perera, Deputy General Manager Eng. R.A.A.S. Seneviratne, Deputy General Manager Eng. N.W. Kumarasingha, and Chief Engineer R.K.P.S. Gunathilake of Ceylon Electricity Board for all the support given to me to complete my research successfully.

I would also like to appreciate my colleagues E.A.E.H. Hemachandra, D.M.D.K. Dissanayake, J.G.S Nalani for the motivation given to me to complete my research work. Also, I would like to thank the members of Energy Management Team of DD3, CEB for their tireless efforts in the field to implement this project.

Finally, I owe my gratitude to my parents, my wife and my little daughter for their endless support and encouragement and without them I would not have come this far.

ABSTRACT

Lightning surges are the major source that causes failure of power electronic equipment in low voltage (LV) power distribution systems, specially for the equipment with low immunity parameters and high sensitivity to surges. The 400/230V low voltage systems are usually affected by lightning mainly by the surges coming through the distribution transformers. In addition to that induced surges or direct strikes on load side could cause damage to distribution substations.

Power utilities are concerned about the possibility of damage to distribution transformers caused by lightning strikes leading power supply failures and other losses including transformer damage, meter equipment damage and damage to the surroundings. Assessment of such occurrences is important in the design of suitable protection schemes and mitigation strategies. The number of incoming surges, their energy content as well as the number and the amplitude of power frequency follow currents determine the level of protection required for each substation. Hence, the assessment of impacts becomes more and more important for the design of lightning protection system.

The methods used in Sri Lanka to assess the impacts of lightning are based on experience of the utility employees or the frequency of protection failures and power supply failures. Specially, when it comes to the low voltage (LV) side, the impacts are not assessed or examined, and in most of the cases, the low voltage side of a substation is not effectively protected from lightning.

In this research the impact of lightning surges particularly on low voltage side of the power distribution substation was analyzed, and the possibilities of using protection mechanism in low voltage side of the power distribution substations were investigated in order to reduce or avoid human and installation damage caused by lightning. Study was limited to power distribution substations in the service area of Distribution Licensee No. 3 (Distribution Division 3 of Ceylon Electricity Board) where the total number of installed distribution substations were around 5000.

Then by simulating the impact of lightning surges on a low voltage side of power distribution substation using PSCAD software, the behavior of the electrical parameters under occurrence of lightning was studied, and based on the observations and results, design parameters for the protection system were derived.

Then the available protection methods for low voltage systems in the world were studied. In the next stage, to protect the low voltage side of the distribution substation economically and safely, application of several protection systems was investigated. Those protection systems included surge protective devices (SPD) and proper grounding mechanisms tried out on LV side of the selected distribution substations of DD3.

Finally, based on the findings of investigation, simulation and pilot installation, a standard protection system was deployed, and results were analyzed to check whether the implemented protection system was effective in electrical terms and monetary terms. Continuous monitoring of protected distribution substations has been carried out and the results were produced in the report.

By the results of the assessment of the impacts of lightning on LV side of power distribution substations, it was obvious that huge amount of visible and invisible losses is incurred to Ceylon Electricity Board. The results of the PSCAD simulation clearly shows that the LV side of the power distribution side is affected in the event of lightning strikes. Hence, it was concluded that the LV side of the power distribution side should be protected to eliminate the impacts of lightning strikes. Finally, this research proposes a standard protection mechanism to protect distribution substations from lightning and the effectiveness of the protection system was proved by the results obtained.

TABLE OF CONTENTS

LIST OF TABLES	vii
LIST OF FIGURES	viii
ABBREVIATIONS	xi
1 INTRODUCTION	1
1.1 Background	1
1.2 Lightning Phenomenon	2
1.3 Impacts of Lightning on Power Distribution Substations	4
1.3.1 Impacts on Medium Voltage side	4
1.3.2 Impacts on Low Voltage side	5
2 PROBLEM IDENTIFICATION.....	6
2.1 Research Approach	6
2.1.1 Distribution Division 3 of CEB	6
2.1.2 Impacts of Lightning in Distribution Division 3 of CEB	7
2.2 Problem Statement	7
2.3 Objectives.....	9
2.4 Methodology	9
2.5 Literature Survey.....	11
2.5.1 Lightning Waveforms	11
2.5.2 Lightning Protection Standards.....	13
2.5.3 Lightning Protection Devices	14
2.5.4 Lightning and the Power Distribution Systems	16
2.5.5 Lightning Impact on Distribution Transformers.....	16
2.5.6 Lightning Protection of Distribution Substations	17
3 ASSESSMENT OF IMPACTS OF LIGHTNING IN DD3	19
3.1 Data Collection of DD3.....	19
3.2 Assessment of Damage on Transformers.....	21

3.3	Assessment of Damage on PPMs.....	23
4	SIMULATION OF LIGHTNING ON PDS	25
4.1	PSCAD Simulation model	25
4.1.1	DT without MV Surge Arrester. Lightning Generated from MV Side .	27
4.1.2	DT with MV Surge Arrester. Lightning from MV Side	29
4.1.3	DT with MV Surge Arrester. Lightning Generated from LV Side.....	31
4.1.4	DT with MV and LV Surge Arresters. Lightning Generated from LV Side	35
4.2	Observations of PSCAD Simulation.....	39
5	DESIGN OF LV SURGE PROTECTION SYSTEM.....	40
5.1	Power Distribution Substation Model.....	40
5.1.1	Behavior of the LV side Parameters During a Lightning Strike.....	41
5.1.2	Lightning Protection Zones (LPZ) of PDS	43
5.1.3	LV Protection Design Algorithm.....	44
5.2	Design of LV Surge Protection System for PDS	45
5.2.1	Design Principles – LV Surge Protection System	45
5.2.2	Design Principles –Protection System Parameters	46
5.2.3	Selection of Protection System	47
6	IMPLEMENTATION OF LV SURGE ARRESTER INSTALLATION.....	50
6.1	Sample Selection of Distribution Substations.....	50
6.2	Installation of LV Surge Arresters	52
6.3	Results of Field Implementation	56
7	CONCLUSION AND RECOMMENDATION.....	59
7.1	Conclusion.....	59
7.2	Recommendation.....	60
7.3	Limitations identified	60
8	REFERENCES	61

LIST OF TABLES

Table 3-1: Distribution Network infrastructure of the DD3 as at year 2014	19
Table 3-2: Cost of Burnt Transformers during 2012-2014 in DD3	22
Table 3-3: Cost of replacing burnt PPMs in 2012-2014 in DD3	23
Table 5-1: Comparison of LV side SPDs	48
Table 5-2: Characteristics of ABB LOVOS 10 Surge Arrester	49
Table 6-1: Sample Selection for Surge Arrester Installation	50
Table 6-2: Selection of Control Sample.....	50
Table 6-3: PPM burnings after LV Surge Protection.....	56
Table 6-4: PPM burnings after LV Surge Protection.....	56

LIST OF FIGURES

Figure 1.1: Distribution Divisions of Ceylon Electricity Board.....	2
Figure 1.2: Global Distribution of Lightning 1995-2003 by NASA	3
Figure 1.3: Seasonal Distribution of Lightning in Sr Lanka 1974 – 2008 (www.desinventar.lk).....	3
Figure 2.1: Area Structure of the Distribution division 3	6
Figure 2.2: Burnt Transformer and damaged wiring and structure at Ukuwelakanda PDS, Horana	8
Figure 2.3: Burnt energy meters and damaged MCB and structure at Super Pack Substation, Sri Jayawardanapura	8
Figure 2.4: Typical Lightning Waveform.....	11
Figure 2.5: Standard Lightning Current Waveforms	12
Figure 2.6: Standard Lightning Voltage Waveform	12
Figure 3.1: Capacity wise Transformer Population	20
Figure 3.2: Area wise Population of Bulk Supply Consumers	21
Figure 3.3: Burnt Transformers During 2012-2014 in DD3.....	21
Figure 3.4: Burnt PPMs during 2012-2014 in DD3.....	23
Figure 4.1: PSCAD Model of Distribution Transformer with Surge Generator.....	26
Figure 4.2: 5 kA Lightning Surge of 10/350 μ s Waveform.....	27
Figure 4.3: Secondary Voltage Waveform at 5 kA Lightning on Primary Side.....	27
Figure 4.4: Secondary Voltage Waveform at 10 kA Lightning on Primary Side.....	28
Figure 4.5: Secondary Voltage Waveform at 40 kA Lightning on Primary Side.....	28
Figure 4.6: V-I Characteristics of Hubbell 36 kV Surge Arrester	29
Figure 4.7: Primary Voltage Waveform at 10 kA Lightning on Primary Side.....	29
Figure 4.8: Secondary Voltage Waveform at 10 kA Lightning on Primary Side with MV Surge Arrester.....	30
Figure 4.9: Secondary Voltage Waveform at 40 kA Lightning on Primary Side with MV Surge Arrester.....	30
Figure 4.10: PSCAD Model of Distribution Transformer with Surge Generator Connected to LV side with MV Surge Arrester.....	31
Figure 4.11: Primary Voltage Waveform at 5 kA Lightning on Secondary Side with MV Surge Arrester.....	32

Figure 4.12: Secondary Voltage Waveform at 5 kA Lightning on Secondary Side with MV Surge Arrester.....	32
Figure 4.13: Primary Voltage Waveform at 10 kA Lightning on Secondary Side with MV Surge Arrester.....	33
Figure 4.14: Secondary Voltage Waveform at 10 kA Lightning on Secondary Side with MV Surge Arrester.....	33
Figure 4.15: Primary Voltage Waveform at 40 kA Lightning on Secondary Side with MV Surge Arrester.....	34
Figure 4.16: Secondary Voltage Waveform at 40 kA Lightning on Secondary Side with MV Surge Arrester.....	34
Figure 4.17:PSCAD Model of Distribution Transformer with Surge Generator Connected to LV side with MV and LV Surge Arresters.....	35
Figure 4.18: Primary Voltage Waveform at 5 kA Lightning on Secondary Side with MV and LV SPDs	36
Figure 4.19: Secondary Voltage Waveform at 5 kA Lightning on Secondary Side with MV and LV SPDs	36
Figure 4.20: Primary Voltage Waveform at 10 kA Lightning on Secondary Side with MV and LV SPDs	37
Figure 4.21: Secondary Voltage Waveform at 10 kA Lightning on Secondary Side with MV and LV SPDs	37
Figure 4.22: Primary Voltage Waveform at 40 kA Lightning on Secondary Side with MV and LV SPDs	38
Figure 4.23: Secondary Voltage Waveform at 40 kA Lightning on Secondary Side with MV and LV SPDs	38
Figure 5.1: Typical Power Distribution Substation	40
Figure 5.2: Single Line Diagram of PDS during Lightning on MV Side.....	41
Figure 5.3: Single Line Diagram of PDS during Lightning on LV Side	42
Figure 5.4: Lightning Protection Zones in PDS.....	43
Figure 5.5: LV Protection Design Algorithm	44
Figure 6.1: Transformers in Selected Sample Against Total in DD3	51
Figure 6.2: LV Surge arrester connection at PDS.....	52
Figure 6.3: LV Arrester Installation at Furgurson Garment, Rathnapura.....	53
Figure 6.4: LV Arrester Installation at Tea Small Holdings, Horana.....	53

Figure 6.5: Installation at Labugama Water Treatment Plant, Awissawella	54
Figure 6.6: Installation on PPM at Sripali, Horana.....	54
Figure 6.7: Disconnected Arrester at Sripali, Horana.....	55
Figure 6.8: Comparison of burnt PPMs in DD3 during 2013 – 2016.....	57
Figure 6.9: Burnt DT during 2013 – 2016 Against the Sample Selected	58
Figure 6.10: Burnt DTs in DD3 during 2012 – 2015.....	58

ABBREVIATIONS

CEB	Ceylon Electricity Board
DD3	Distribution Division 3
kVA	kilovolt Ampere
kW	kilo Watt
kWh	kilo Watt hour
LV	Low Voltage
MV	Medium Voltage
HV	High Voltage
HT	High Tension
LT	Low Tension
PDS	Power Distribution Substation
DT	Distribution Transformer
SPD	Surge Protection Device
I_n	Nominal Discharge Current
I_{imp}	Impulse current
U_c	Continuous Operating Voltage
U_p	Protection Voltage
BIL	Basic Insulation Level
ac	Alternating Current
PPM	Programmable Polyphase Meter
TDT	Time of Day Tariff
CT	Current Transformer
MOV	Metal oxide varistor

1 INTRODUCTION

1.1 Background

Power distribution substations (PDS) are the end point of national grid where electricity is distributed at desired voltage levels to the consumers. These substations consist of power transformers, energy meters, circuit breakers, power cables, medium voltage (MV) lightning arresters, mounting structures, cubicles and other equipment. Protection of these substations is crucial to ensure a reliable, uninterrupted electricity supply. Lightning strikes are a major cause of distribution substation breakdowns. MV side of the distribution substation is protected against lightning by installing lightning arresters and LV side is not protected by any means. However annually a huge number of distribution transformers are failed and a huge cost is incurred for replacing damaged equipment and a huge loss of revenue is caused by power interruptions as well. No any studies had been done to investigate the impacts of lightning surges encountering at LV side of PDS putting the LV side of the PDS wide open to vulnerable surge currents.

Distribution System of CEB consists of four Divisions. The Distribution Network System consists of 33kV and 11kV Medium Voltage (MV) lines and 400V Low Voltage (LV) lines absorbing power from 132kV and 220kV Transmission System via Grid Substations (GSS).

Four Distribution Divisions are formed with the following Provinces:

Division 1: Colombo City, North Western Province, North Central Province and Northern Province.

Division 2: Western Province North, Central Province and Eastern Province

Division 3: Western Province South II, Uva and Sabaragamuwa

Division 4: Western Province South I and Southern Province.

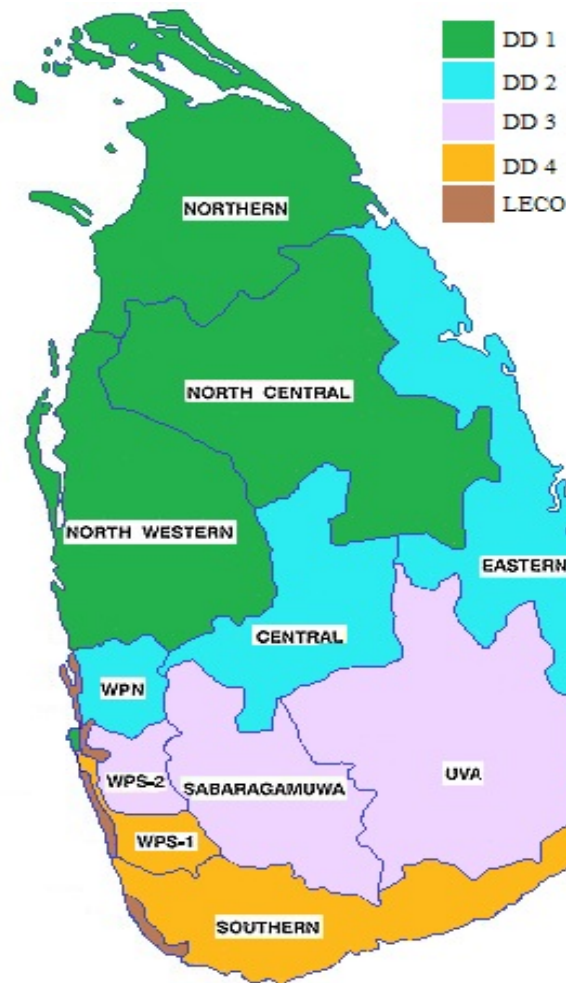

Figure 1.1: Distribution Divisions of Ceylon Electricity Board

1.2 Lightning Phenomenon

Lightning is the occurrence of a natural electrical discharge of very short duration and high voltage between a cloud and the ground or within a cloud, accompanied by a bright flash and a thunder. Cloud-to-ground lightning bolts are a common phenomenon. Only 10% of lightning occurs between clouds and ground. About 100 lightning surges strike Earth's surface every single second.

75% of lightning events have more than one common stroke. Generally, 3 or 4 but up to 10 possible. Average lightning current are in the range of 10 – 20 kA where the maximum currents could go up to 200 kA. These surge currents are in high frequency ranges between 1 kHz – 100 kHz.

Sri Lanka has identified occurrence of lightning as a natural disaster where proper safety and protection mechanism should be implemented to avoid damage to human lives and equipment.

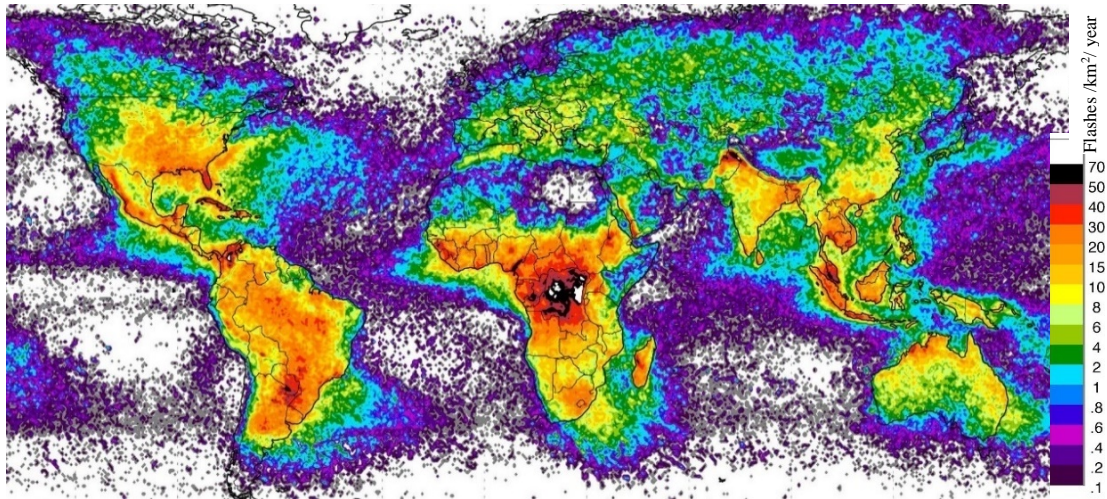

Figure 1.2: Global Distribution of Lightning 1995-2003 by NASA

According to the lightning researches done by NASA during the period of 1995 - 2003, Figure 1.2 shows that Sri Lanka is in a zone where the ground flash density of lightning strikes is around 30 flashes/km²/year. Lightning activity over Sri Lanka shows peaks during the two Inter-monsoon seasons of March-April and October-November.

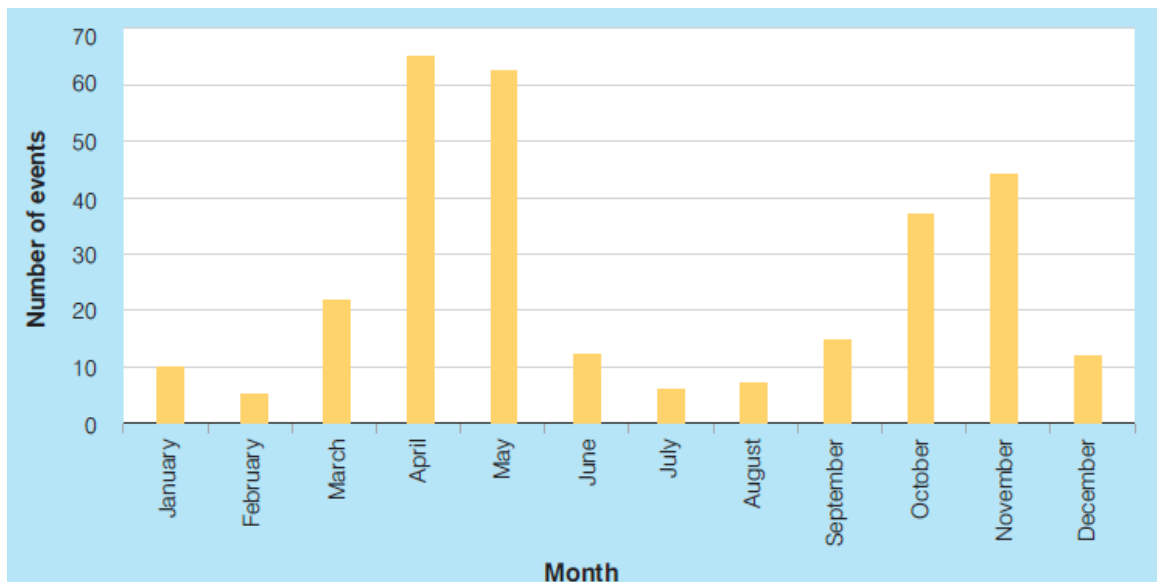

Figure 1.3: Seasonal Distribution of Lightning in Sr Lanka 1974 – 2008
(www.desinventar.lk)

1.3 Impacts of Lightning on Power Distribution Substations

In the normal operation of power systems, unavoidable disturbances and interruptions occur due to direct lightning strikes or induced surges caused by lightning strikes on surrounding structures. Power distribution transformers are more prone to impacts of lightning as they are installed in outdoor and connected to overhead incoming and outgoing conductors. In case of direct strike, an impulsive lightning current is injected into an overhead line section or power transformer itself, which causes a surge voltage to propagate towards the power transformer windings, load cables and further to the consumer installations. Similar phenomena could be observed when the electric charges accumulated on the surrounding structures are released rapidly into the power distribution substation when the lightning strikes on to surrounding structures of the substation. These structures include trees, overhead power lines, towers, buildings, etc.

1.3.1 Impacts on Medium Voltage side

The Medium Voltage (MV) side of the power distribution substations are frequently affected by lightning and it is identified as the main reason for distribution transformer failures. Most of the distribution transformer failures occur due to insulation failures and winding failures caused by surge currents, which the transformers are exposed during a longer period of time. The steep front of a surge wave generated by a lightning strike can cause deterioration in the insulation and ultimately lead to a dielectric breakdown. The voltage distribution along transformer MV winding becomes non-linear under surge conditions due to the capacitive currents [1].

CEB has in its distribution network, transformers with capacities from 100 – 1000 kVA and allocate a huge cost to purchase them and to replace them. The hidden costs such as labor cost, transport cost, management cost and the revenue loss due to outages are not reflected as technical losses. CEB distribution network is frequently attacked by lightning strikes and when such happens near a distribution transformer a surge is applied on the primary winding of the transformer. The impulsive surge currents can lead to disasters including transformer and other installation failures. The frequency and severity of this scenario depends on several factors, such as the magnitude of the

surge, number of multiple strokes, protection margin produced by the surge arresters etc. An appreciable number of transformer failures occur due to insulation failures notably at points near line ends [1]. Surge arresters are used to protect transformers against surges but their performance diminishes with time depending on its quality, number of strokes handled, environmental conditions etc. Poor quality surge arresters will not function properly and may activate after the rise time of the surge waveform. It can be commonly seen that the arrester's interconnection earth leads are not having enough cross section to handle heavy lightning surges [1]. simulations clearly reveal the improvement of the surge withstand capability of distribution transformers with the use of electrostatic shields.

1.3.2 Impacts on Low Voltage side

Studies had been carried out to investigate the level of overvoltage surges appearing on the low voltage (LV) side of power distribution substations due to lightning strikes on medium voltage power lines and induced surges on LV side generated on LV distribution lines, LV equipment, earthing cables, load cables in consumer premises and other equipment installed in substation premises. A number of factors are involved in low voltage distribution systems that may give rise to an unacceptable level of overvoltage due to lightning surges. These include the length of feeders, number of feeders, length of load cables, power rating of the transformer and etc.

Direct and induced lightning surges might cause severe overvoltage disturbances to sensitive equipment connected to low voltage network. Although the cables reduce the surge magnitude, a low voltage system with cables usually experience overvoltage surges penetrating into the system due to remote strikes on the MV distribution lines. Long fronted direct strikes are more damaging than those of short fronted impulses. Whereas the overvoltage disturbances caused by induced surges either on MV or LV overhead lines are relatively lower than that of direct strikes, they cannot be ignored and left untreated.

2 PROBLEM IDENTIFICATION

2.1 Research Approach

2.1.1 Distribution Division 3 of CEB

DD3 is selected as the working scope for this research. DD3 distribution licensee covers Sabaragamuwa Province, Uva Province and a part of Western Province called Western Province South - 2. Those provinces are divided into 13 Areas and 42 Consumer Service Centers. Total of 1,104,507 retail consumers and 1,654 bulk consumers (consume more than 42 kVA per month) are served through 5,101 power distribution substations available in DD3. These transformers are in a range of 100 kVA – 1,000 kVA in capacity and 33 kV/400 V or 11 kV/400 V levels.

Out of the 13 areas of DD3, most of them are with higher Isokreunic levels and higher ground flash densities. For example, Horana, Bandaragama, Ruwanwella, Awissawella, Ehaliyagoda, Rathnapura areas suffer because of frequent heavy lightning surges. Figure 2.1 shows the area structure of DD3.

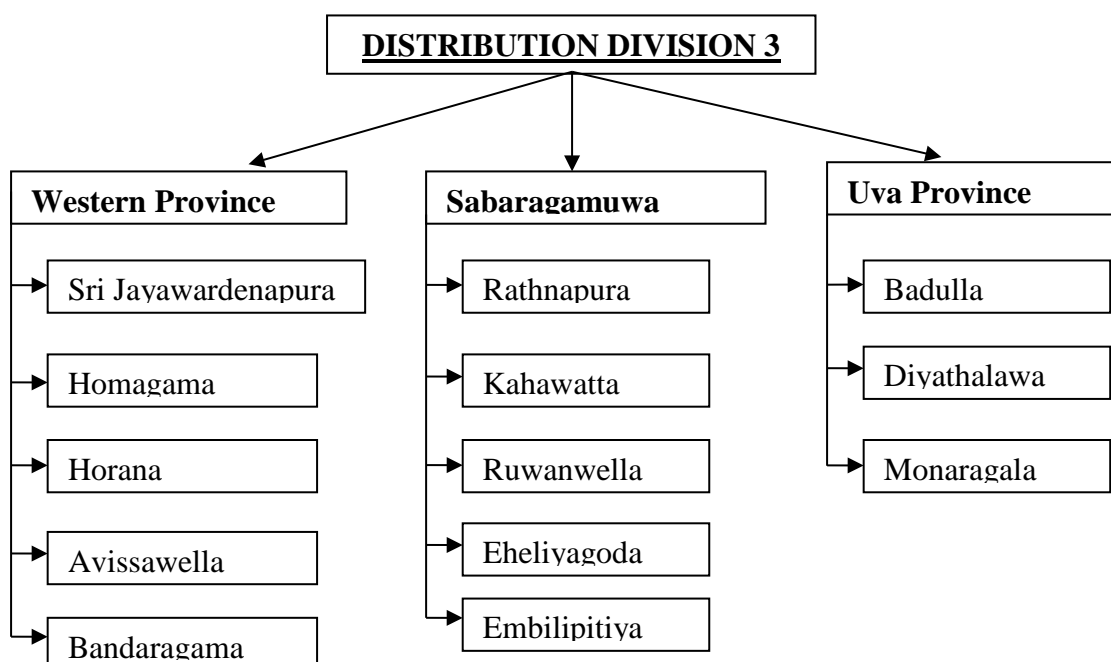

Figure 2.1: Area Structure of the Distribution division 3

2.1.2 Impacts of Lightning in Distribution Division 3 of CEB

Electricity distribution system of Sri Lanka, suffers very badly because of the severe lightning strikes happen throughout the year. Lightning activity is very high during rainy seasons such as months of April, May, November and December causing severe problems to power distribution system. Most of the areas in DD3 are highly affected by lightning strikes throughout the year as the Isokeraunic level of those areas are very high exceeding 90 thunder days per annum.

Most of the lightning surges do not give rise to visible damage at once, instead they cause degradation in the electrical equipment and power system. Repeated exposure to such transients will finally cause the permanent equipment failure. Most often such failure occurs in a totally unsuspecting atmosphere, thus the cause of failure is hardly attributed to the correct source. CEB distribution system also face the same scenario, where the unseen damage caused by lightning has the major component. Although the MV side of the PDSs are protected by lightning arresters, the LV side remains unprotected.

2.2 Problem Statement

Out of 5,100 transformers installed in DD3, around 2% have to be replaced annually and the cause is not verified in most of the cases. The field staff report these failures categorizing under; winding failures, insulation failures and physical damage to transformer bushings. Not only the transformer failures, but also the damage caused to energy meter, electrical wiring and electrical appliances at the consumer end need to be accounted as lightning damage. There are reports of failure of the distribution system with damage to lightning arresters, DDLO fuses, and surrounding structures as well. In general, the secondary side of the distribution transformer is not protected against lightning surges so that the induced voltage caused by lightning exceeds the basic insulation levels (BIL) of the equipment in the LV system.

Hence, it is mandatory to study the impact of lightning on the secondary side of the distribution substations to ensure that the PDSs and the consumers are protected from direct or induced lightning surges.

This research aims to identify the impact of lightning on LV side of the PDSs and to introduce a protection mechanism to protect the LV side of the PDSs. Figures 2.2 shows some incidents where lightning caused severe damage to distribution transformer and metering arrangements. Figure 2.3 shows the damaged pre programable meters and damaged meter enclosure caused by lightning.



Figure 2.2: Burnt Transformer and damaged wiring and structure at Ukuwelakanda PDS, Horana



Figure 2.3: Burnt energy meters and damaged MCB and structure at Super Pack Substation, Sri Jayawardanapura

2.3 Objectives

Objectives of this research are as follows.

- Qualitative and quantitative assessment of impacts of lightning surges on LV side of Power Distribution Substations.
- Modeling of Substation to identify and assess the impacts of lightning on LV side of the PDS.
- Implementation of LV lightning protection system for Power Distribution substations in Distribution Division 3 of Ceylon Electricity Board.
- To establish a continuous monitoring system for the protection of LV side of the PDSs in DD3.
- Reduction of losses related to meter burnings transformer damaging, electrical wiring and structure damage, etc.
- Protection of consumer equipment and installations attached to the LV distribution system.

2.4 Methodology

Following methodology is used throughout this research. PSCAD simulation was used to theoretically analyze the impacts of lightning on LV side of the power distribution substations. Field implementation is used to verify the observations achieved by the theoretical modelling.

Literature survey

- Study of the impacts of lightning surges on LV side of Distribution Substations (DS).
- Study of the behavior of LV side parameters under lightning surges.
- Study of the PSCAD simulation of distribution substations under lightning conditions.
- Study on designing of Lightning Protection system for LV side of distribution substations.
- Study on the lightning protection systems for LV side of distribution substations.

Data collection and Assessment of Impacts of Lightning in DD3, CEB

- Details of substations in areas highly affected by lightning.
- Details of losses caused by lightning in those substations.
- Quantitative assessment of visible damage caused by lightning.

PSCAD Simulation of Distribution Substation behavior at Lightning

- Simulation of varying lightning surges and distribution transformer.
- Simulation of behavior of electrical parameters of LV side at the occurrence of lightning surges with different magnitudes.

Design of Lightning Protection System for LV side

- Implementation of design algorithm to select protection parameters and type of protection devices.
- Calculation of main electrical parameters of protection device (U_c , U_p , I_n , I_m) as per IEC 61643-11 :2011.
- Design of installation modes and installation locations based on distribution substation model.

Field Implementation of Surge Protection Devices to Distribution Substations

- Sample study on selected distribution substations to select the most suitable protection device.
- Pilot implementation of SPDs on LV side of the power distribution substations.
- Implementation of Selected SPDs on PDSs in DD3, CEB.
- Continuous monitoring of substations where SPDs are installed.

Technical and Financial Evaluation of Results of the Field Implementation

- Deriving conclusions based on results of field implementation.
- Protection effectiveness and cost benefit analysis of SPDs on LV side of DS.
- Improvement of protection techniques according to feedback.

2.5 Literature Survey

2.5.1 Lightning Waveforms

Lightning strikes are standardized into few waveforms for the modeling, experimental surge generation and for designing surge protection devices. Two basic types of flashes exist as defined in IEC 62305-1: 2010.

- downward flashes initiated by a downward leader from cloud to earth;
- upward flashes initiated by an upward leader from an earthed structure to cloud.

Mostly downward flashes occur in flat territory, and to lower structures, whereas for exposed and/or higher structures upward flashes become dominant. With effective height, the probability of a direct strike to the structure increases and the physical conditions change.

Lightning waveforms are distinguished as per the time duration of the lightning, magnitude of the lightning voltage and the lightning current, the number of strokes per lightning strike and the steepness of the impulses.

Typical lightning waveform has two exponential wave shapes which represents steep rise time and the decaying time. Figure 2.4 shows the characteristic curve of a typical lightning surge.

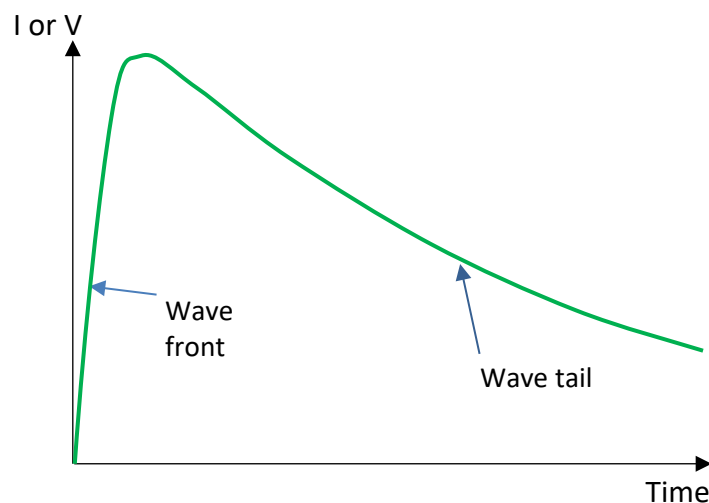

Figure 2.4: Typical Lightning Waveform

Two types of current waves are considered by the IEC standards. These two types of lightning current waves are used to define tests on SPDs (IEC standard 61643-11: 2011) and equipment immunity to lightning currents.

- 10/350 μs wave: to characterize the current waves from a direct lightning stroke as shown in Figure 2.5 (a).
- 8/20 μs wave: to characterize the current waves from an indirect lightning stroke as shown in Figure 2.5 (b).

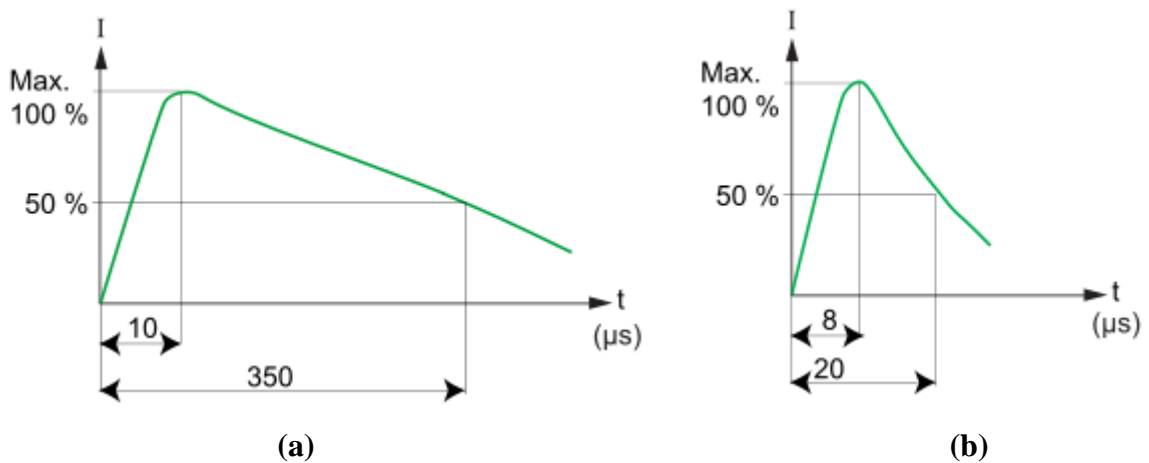

Figure 2.5: Standard Lightning Current Waveforms

The over voltages created by lightning strikes are characterized by a 1.2/50 μs voltage wave as shown in Figure 2.6. This type of voltage wave is used to verify equipment's withstand to over voltages of atmospheric origin.

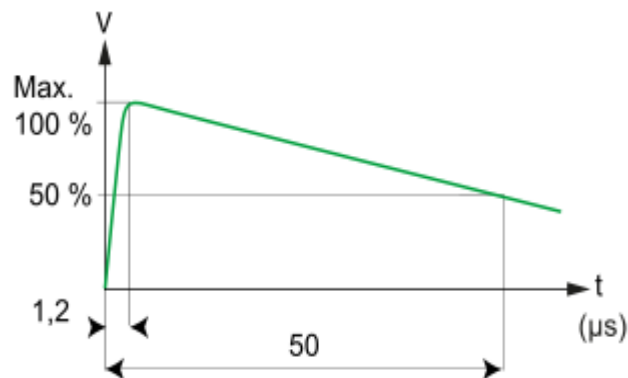

Figure 2.6: Standard Lightning Voltage Waveform

2.5.2 Lightning Protection Standards

The IEC 62305 series (part 1 to 5) restructures and updates the publications of IEC 61024 series, IEC 61312 series and IEC 61663 series.

IEC 62305-1:2010 provides general principles to be followed for protection of structures against lightning, including their installations and contents, as well as persons.

The need for protection, the economic benefits of installing protection measures and the selection of adequate protection measures should be determined in terms of risk management. Risk management is the subject of IEC 62305-2.

The criteria for design, installation and maintenance of lightning protection measures are considered in three separate groups:

- The first group concerning protection measures to reduce physical damage and life hazard in a structure is given in IEC 62305-3.
- The second group concerning protection measures to reduce failures of electrical and electronic systems in a structure is given in IEC 62305-4.
- The third group concerning protection measures to reduce physical damage and failures of services connected to a structure (mainly electrical and telecommunication lines) is given in IEC 62305-5.

IEC 61643-11:2011 is applicable to devices for surge protection against indirect and direct effects of lightning or other transient over voltages. These devices are packaged to be connected to 50/60 Hz ac power circuits, and equipment rated up to 1,000 V r.m.s.

IEC 61643-12:2008 describes the principles for selection, operation, location and coordination of SPDs to be connected to 50 Hz to 60 Hz a.c. and to d.c. power circuits and equipment rated up to 1 000 V r.m.s. or 1 500 V d.c.

2.5.3 Lightning Protection Devices

A surge protective device (SPD) is a device that limits transient voltage surges and runs current waves to ground to limit the amplitude of the voltage surge to a safe level for electrical installations and equipment. The surge protective device includes one or several nonlinear components. When a voltage surge exceeds a voltage threshold, the SPD conducts the energy to earth or divert the energy to another active conductor.

The SPD has an internal thermal protection device which protects against burnout at its end of life. Gradually, over normal use after withstanding several voltage surges, the SPD degrades into a conductive device. Then the thermal protection mechanism operates and disconnect the SPD from the system to avoid power frequency current flow to the earth.

Three test classes are defined for SPD in International standard; IEC 61643-11:2011- Surge protective devices connected to low-voltage power systems - Requirements and test methods.

- Class I test: Test carried out with the maximum impulse current I_{imp} (typical current shape 10/350).

The class I tests is intended to simulate partial conducted lightning current impulses. SPDs subjected to class I test methods are generally recommended for locations at points of high exposure, e.g., line entrances to buildings protected by lightning protection systems.

- Class II test: It is conducted using crest value of the current through the SPD having a current wave shape of 8/20.
- Class III test: It is conducted using the combination waveform (1.2/50 and 8/20 μ s).

SPDs tested to class II or III test methods are subjected to impulses of shorter duration. These SPDs are generally recommended for locations with lesser exposure.

Following parameters are defined related to low voltage surge protection devices by IEC 61643-11: 2011.

- I_n : Nominal discharge current; the crest value of the current through the SPD having a current waveform of 8/20. This is used for the classification of the SPD for the class II test and also for preconditioning of the SPD for class I and II tests.
- I_{max} : Maximum discharge current for class II test; crest value of a current through the SPD having an 8/20 waveform and magnitude according to the test sequence of the class II operating duty test. I_{max} is greater than I_n .
- I_{imp} : Impulse current, it is defined by a current peak value I_{peak} and the charge Q . Tested according to the test sequence of the operating duty test. This is used for the classification of the SPD for class I test.
- U_c : Continuous operating voltage; the maximum r.m.s. or d.c. voltage which may be continuously applied to the SPDs mode of protection. This is equal to the rated voltage.
- U_p : Voltage protection level; a parameter that characterizes the performance of the SPD in limiting the voltage across its terminals, which is selected from a list of preferred values. This value shall be greater than the highest value of the measured limiting voltages. The most common values for a 230/400 V network are: 1 kV - 1.2 kV - 1.5 kV - 1.8 kV - 2 kV - 2.5 kV.
- Measured limiting voltage; the maximum magnitude of voltage that is measured across the terminals of the SPD during the application of impulses of specified wave shape and amplitude
- U_{res} : Residual voltage, the peak value of the voltage that appears between the terminals of an SPD due to the passage of discharge current.

2.5.4 Lightning and the Power Distribution Systems

There are reports on damages due to lightning surges to the LV distribution system as well as electrical installations at the consumer ends [1]. A lightning strike to a LV power line will propagate to the transformer because of resistive coupling. A strike to an MV line may transfer part of the energy through both inductive and capacitive coupling to the transformer [2]. There can also be a resistive coupling if there is an insulation breakdown between the windings. A nearby strike basically induces voltage impulses in distribution lines through inductive coupling while strikes near to the utility may cause a potential rise in the earthing system which leads to resistive coupling.

Lightning over voltages on LV networks can be produced by several mechanisms, but the most important ones, in terms of voltage magnitudes and frequency of occurrence, are related to transference from the primary side and to induction by nearby strokes. Over voltages of much higher magnitudes are produced by direct strokes, but this situation is not so often due to the shielding from tall objects and the primary line and to the limited length of the exposed secondary circuits [5]. In general, the distribution network consists of a step-down transformer together with a radial distribution network towards the consumer end and it is therefore, surge transfer through the distribution transformer has become very crucial.

2.5.5 Lightning Impact on Distribution Transformers

If the lightning surges are severe, it may even blast the arresters and drop down lift off (DDLO) fuses. Some surges may enter to the distribution transformers from HV side to the ground through the tank through oil insulation consequently reduces the insulation resistance of the transformer [3]. In some cases, surge transfer through oil form oil-vapor and the oil may come out from the pressure valve of the transformer and the seals between the transformer bushing and the transformer body.

When the surges are less severe and are below the cut-off voltage of the lightning arrester, the surge may transfer to the secondary and propagate towards the consumer end. Depending on the surge magnitude and gradient in one side and the breakdown strength of the apparatus on the other side, the surge may damage to energy meter,

RCCB and other electrical appliances in the consumer premises [3]. The magnitudes of the voltages transferred to the secondary in the event of direct strikes to the primary circuit, in some cases, can be high enough to cause failures on the LV winding [5].

TT arrangement is used in the distribution network of CEB, with primary side delta connected and the secondary side star connected with grounded neutral. The transformer tank and the surge arresters at the delta connected side are grounded separately.

The LV windings are first wound on top of the transformer core whereas the HV windings are wound next. The insulation between the LV and HV windings is about 20 mm consisting two zig-zag oil-impregnated pressboard insulation separated by a cylindrical pressboard of 1 mm thickness. Transformer oil is circulated through the space within the zig-zag pressboard. Between HV to ground, the insulation is almost the transformer oil whereas between LV to core, a pressboard is included in addition to transformer oil [3].

2.5.6 Lightning Protection of Distribution Substations

The role of surge protective devices (SPDs) is twofold. As a transient propagates in a line, the SPDs should switch itself from high impedance mode to low impedance mode for a short duration allowing the transient to pass into earth. After that it should be switched back to the high impedance mode. In the event of a ground potential rise such as a nearby lightning to strike to ground, the SPDs should be switched into low impedance mode equalizing the earth, neutral and line potentials [2].

Installation of LV arresters leads to a great reduction in the failure rate of pole mounted transformers. The main conclusion drawn from investigations conducted in Australia, Norway, and the USA is that the installation of arresters at the secondary terminals leads to a significant reduction in the distribution transformer failure rate [5].

To reduce the impact of surges generated at the MV side on secondary side, the MV arresters should be installed as close as possible to the transformer bushings, preferably at a distance shorter than 0.4 m, with their grounding terminals connected to the

transformer tank through a cable shorter than 0.4 m [5]. Such measure will result in a substantial reduction of the occurrence probability, at the transformer terminals, of lightning over voltages with magnitudes higher than the insulation capability. From impulse tests on the transformer LV windings, it is known that surges exceeding 30 kV damage the LV windings. But as has already been considered, long-duration surges of a smaller magnitude (perhaps as low as 3 kV) may transfer sufficient voltage to the high-voltage (HV) winding to damage its insulation [6].

LV surge arresters come in the form of modules to be installed inside the LV switchboard. There are also plug-in types and those that protect power outlets. Some are built for outdoor installation such as on transformer bushings. Properly applying a surge protective device (SPD) is dependent on the configuration of the power distribution system and equipment connected to the electrical distribution Network [6].

The most important parameter for the selection of a metal–oxide arrester is the highest power frequency voltage which the arrester can continuously withstand. It is often called as maximum continuous operating voltage (MCOV). The surge arrester protection level is usually determined as the ratio where the voltage peak value on the arrester terminals during flow of the nominal discharge current. For different types of sparkles arresters and various manufactures, it is contained in the three to five limits. When selecting the arresters type, attention should be given to the value of this ratio. The lower the ratio is, the greater the insulation protective margin of protected equipment will be [6].

3 ASSESSMENT OF IMPACTS OF LIGHTNING IN DD3

3.1 Data Collection of DD3

Details of distribution network infrastructure of the DD3 including number of consumers are shown in Table 3-1.

Table 3-1: Distribution Network infrastructure of the DD3 as at year 2014

Description	Units	DD3 Data
No. of LV Distribution Substations	No.	5,101
33kV Distribution Lines	km	7,947.9
11kV Distribution Lines	km	39.68
11kV Underground Cables	km	4.58
No. of 33/11kV Primary Substations	No.	11
LV Distribution Lines	km	28,190.41
Bulk consumers at the end of the year	No.	1,654
Retail consumers at the end of the year	No.	1,104,507

DD3 has more than 5,000 substations serving more than 1 Million consumers. These substations have 33kV/400V transformers of capacity varying from 100-1,000 kVA. Winding configuration of the transformers are Star-Delta for 33kV/400v respectively and it is of the type double-wound, oil immersed naturally cooled and hermetically sealed fully filled type. The high voltage winding is a layered winding and the low voltage winding is of foil winding using Copper sheets. The transformer tank is fabricated from steel and All transformers are suitable for outdoor mounting on pole or plinth platforms. All bushings (MV and LV) are of porcelain clad, and creepage distance of the bushing insulator is 720 mm.

According to the TT wiring configuration, the floating point of LV star winding is effectively grounded via neutral bushing of the LV side. Transformer body is also separately grounded. Figure 3.1 shows the capacity wise transformer population of DD3.

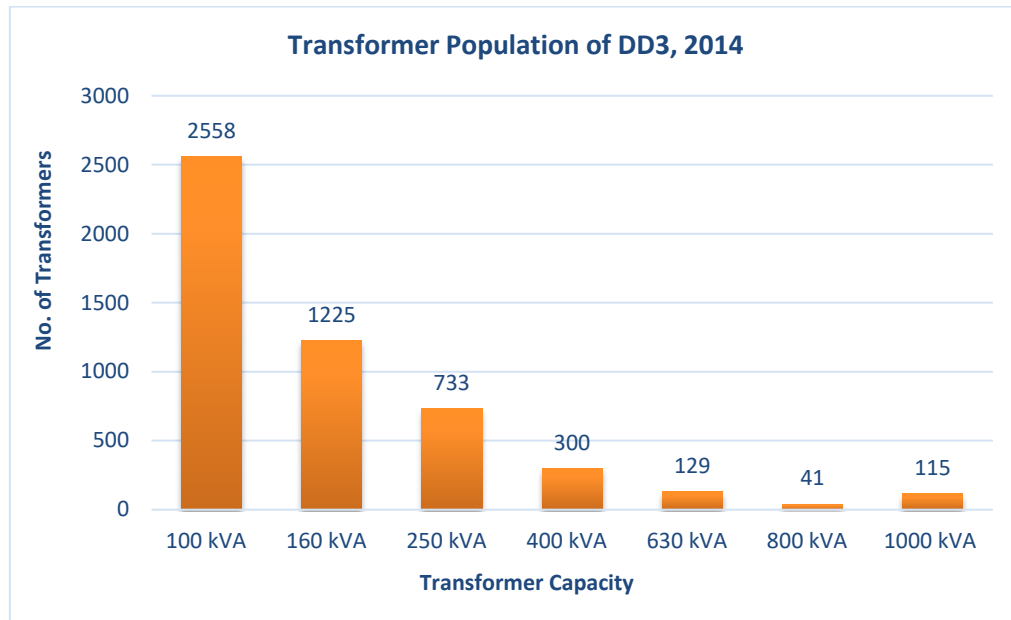

Figure 3.1: Capacity wise Transformer Population

Bulk Customers are provided with an energy meter (kWh) and a maximum demand meter (kVA) (The maximum demand meter measures the maximum power Demand of the Bulk Consumer during an integration period of 15 minutes) and charged under the relevant tariff category. Presently, most of the Bulk Customers are provided with Polyphase Programmable Meters (PPM), which can measure both the energy consumption and the maximum demand. These meters are of Class 1.0 or superior, and the integration period is 15 minutes for kVA measurement. They are usually installed inside a separate enclosure. These meters are usually connected to the Load by a current transformer (CT) of either Class 0.5 or Class 0.2 depending on the specific requirements. Three-phase, four wire meters are used for LV-metered Bulk Customers and three-phase, three-wire meters are used for HV-metered Bulk Customers. The new PPMs installed at Bulk Customer's premises are programmed for Time of the Day Tariff (TDT) metering, and may have the capability for remote reading. However, CEB has the right to connect some distribution feeders to those bulk supply transformers as well.

Area wise population of bulk supply consumers with PPMs is shown in Figure 3.2. This data is important as the PPMs are frequently damaged by lightning surges.

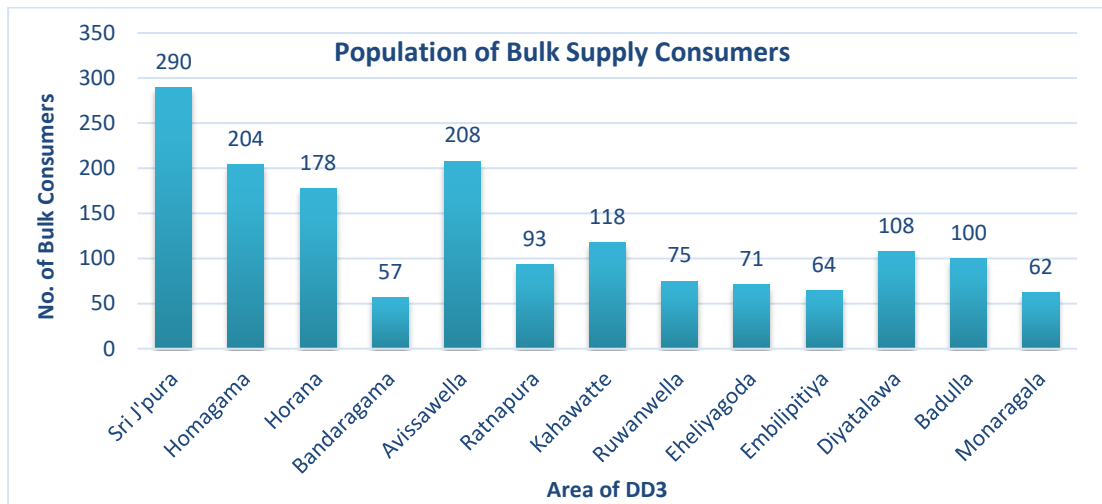

Figure 3.2: Area wise Population of Bulk Supply Consumers

3.2 Assessment of Damage on Transformers

Distribution transformers and the programmable polyphase meters are the frequent victims of lightning surges in DD3. Average of 100 transformers are replaced per annum in DD3 and most of them are replaced due to winding failures and insulation failures caused by lightning. Figure 3.3 shows the burnt transformers during 2012-2014.

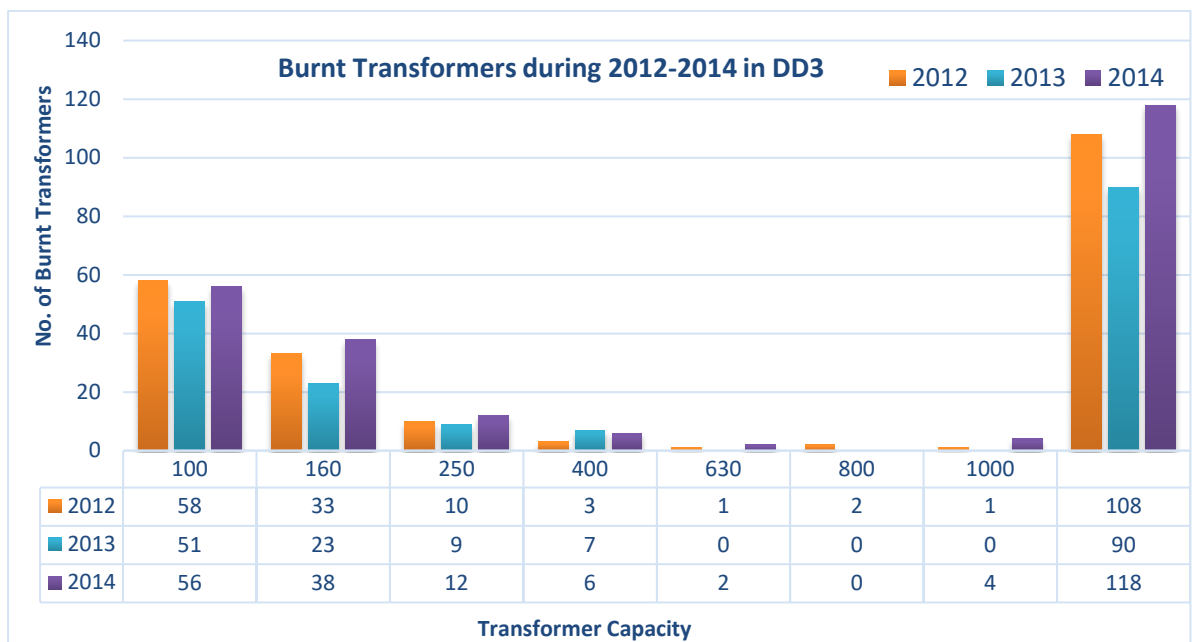

Figure 3.3: Burnt Transformers During 2012-2014 in DD3

The reason behind the burning of transformer cannot be determined exactly. But most of the time the transformers are burnt in areas where lightning strikes are frequent and in higher magnitudes. In most of the cases, the field staff identify the failure reason as lightning depending on environmental factors and by experience of lightning frequency of particular area.

Furhter the prolonged exposure to the lightning cause degradation of transformer insulation and eventually cause the failure of transformer. Cost of replacing transformers is calculated as below for the period of 2012-2014 in DD3.

Table 3-2: Cost of Burnt Transformers during 2012-2014 in DD3

Year\kVA	100	160	250	400	630	800	1000
No. in 2012	58	33	10	3	1	2	1
No. in 2013	51	23	9	7	0	0	0
No. in2014	56	38	12	6	2	0	4
Total No.	165	94	31	16	3	2	5
Price of T/F (Rs.)	765,000	950,000	1,193,000	1,765,000	2,400,000	2,800,000	3,250,000
Total Cost (Rs.)	126,225,000	89,300,000	36,983,000	28,240,000	7,200,000	5,600,000	16,250,000
Total Cost (Rs.)	309,798,000.00 (Three Hundred Ten Million)						
Avg. Cost per Annum (Rs.)	103,266,000.00 (One Hundred Three Million)						

Transformer prices were obtained from the Price List of CEB of year 2012, 2013, 2014.

The overhead cost of replacing transformers including trasportation cost, labour cost, and the loss of revenue caused by power interupption has been assumed as negligible compared to the cost of transformer. Apart from the cost, the inconvenience faced by the consumer also should be considered as a huge impact.

However, unaccountable and hidden damage caused over a long period of time is also very high and has significant impact on distribution network.

3.3 Assessment of Damage on PPMs

Burnt programmable polyphase meters connected to bulk supply consumers during 2012-2014 are shown in Figure 3.4.

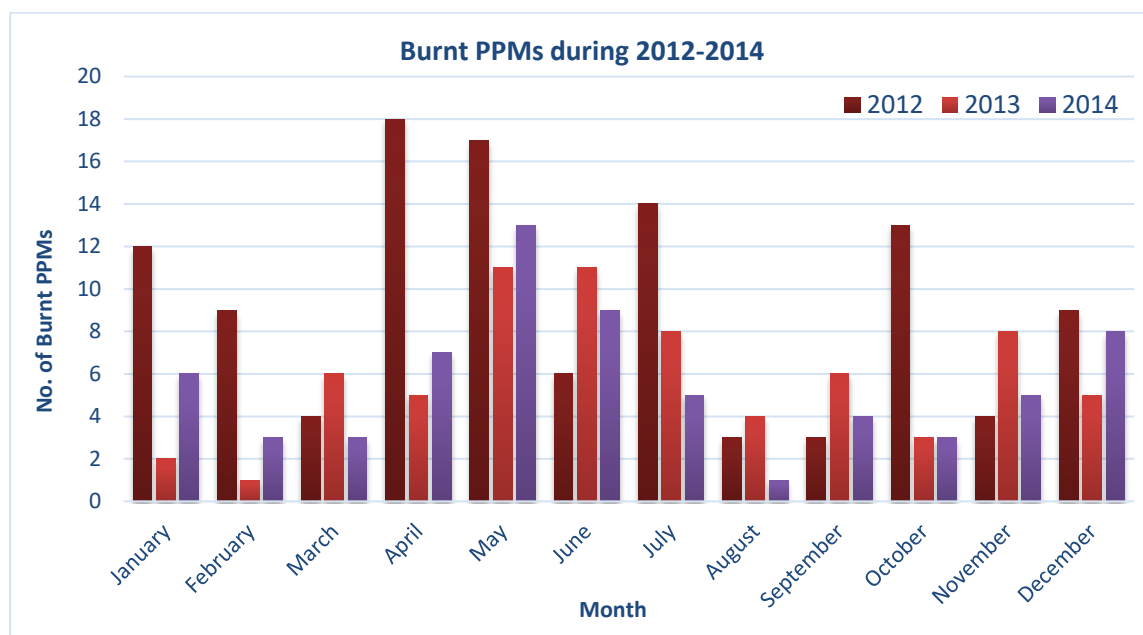

Figure 3.4: Burnt PPMs during 2012-2014 in DD3

From the graph, it is visible that burning of PPMs has increased in the months of April-May and November-December. Cost of replacing burnt PPMs during 2012-2014 in DD3 is shown in Table 3-3.

Table 3-3: Cost of replacing burnt PPMs in 2012-2014 in DD3

Description	Cost (Rs.)
Average list price of 1 PPM (Rs.)	40,000.00
Cost overhead per changing 1 PPM	
Salaries of Employees (1ES + 2 JTM + Driver)	3,541.67
Transportation Cost	618.49
Accessories and consumables	600.00
Total cost for replacing 1 PPM	44,030.99
Total number of burnt PPMs	242.00
Total cost of Burnt meters (2012, 2013, 2014)	10,831,958.00
Average Cost of Burnt PPMs per Annum	3,610,652.00

PPM is a sophisticated equipment with lot of electronics inside and it is also connected to a modem device for remote communication and remote meter reading. BIL of PPM is 6 kV and it cannot withstand average lightning surges attacking the LV side of the distribution transformer. The voltage terminals of the PPM attract lightning surges into the PPM and over voltage surges damage the sensitive circuitry causing burnt equipment. Most of the lightning damaged PPMs cannot be repaired as the whole meter is burnt causing irrevocable damage by lightning.

From the quantitative data of damage caused by lightning on transformers and PPMs, it is obvious that the LV side of the PDSs should be protected from lightning. With the cost of replacing damaged structures, wiring and other equipment, the impact of lightning on LV side of the PDS is much greater than the calculated amount.

In CEB distribution network, the LV side is not protected against lightning by any means. Consumers use LV surge protection devices or they used to switch off and isolate their equipment and installations during heavy lightning periods.

From the utility point of view, CEB believes that MV surge protection systems are adequate to protect the whole distribution substation and consumer side equipment. However, if the MV surge protection system has failed to cover all the impacts of lightning, specially the surges generated form the secondary LV side.

4 SIMULATION OF LIGHTNING ON PDS

4.1 PSCAD Simulation model

PSCAD model was developed to simulate impact of lightning on the LV side of the PDS. The model used a high frequency single phase transformer model [3] as the DT. In this transformer model, it is assumed that similar surges propagate towards three phases and considered a single phase for simplicity. In this model, all the winding impedances, shunt elements, capacitances (between LV to HV windings, LV to ground, HV to ground and within windings) were considered and primary side parameters are referred to secondary side. By applying Kirchoff's circuit law at the secondary side output, the transfer function of the transformer was derived [3].

The most common transformer available in CEB distribution network is 100 kVA, 33kV/400V transformer manufactured by LTL Holdings. Therefore, electrical parameters of 100 kVA, 33kV,400V were used for modeling. Standard lightning surge voltage waveform of 10/350 μ s waveform was used for modeling. Surge waveform simulation was done using double exponential waveform generators and gain functions in PSCAD. Four scenarios were modeled as mentioned below.

1. Distribution transformer (DT) without MV surge arrester. Lightning surge generated from MV side.
2. Distribution transformer with MV surge arrester. Lightning surge generated from MV side.
3. Distribution transformer with MV surge arrester. Lightning surge generated from secondary side (LV side).
4. Distribution transformer with MV surge arrester and LV surge arresters. Lightning surge generated from secondary side (LV side).

In each of the above scenarios, surge waveforms of different magnitude were generated and the output of primary and secondary was observed.

Figure 4.1 shows the simulation model of distribution transformer with surge generator, MV surge arrester and output channels.

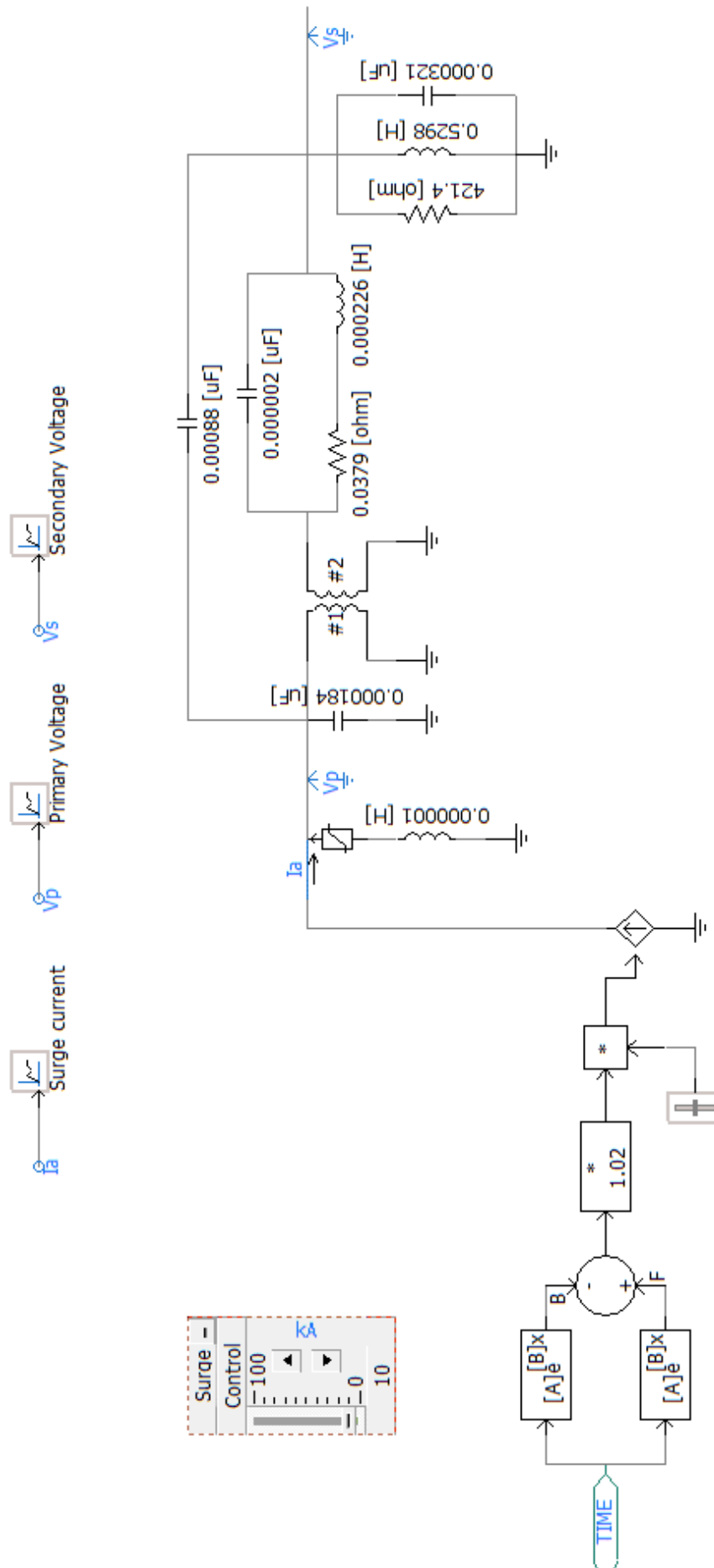

Figure 4.1: PSCAD Model of Distribution Transformer with Surge Generator

4.1.1 DT without MV Surge Arrester. Lightning Generated from MV Side

Case 1 – 5 kA Lightning generated from MV side

Probability of occurrence of 5 kA lightning is 0.95 as per IEC 62305-1: 2010.

Figure 4.2 shows the 5 kA Lightning surge of 10/350 μ s waveform generated by the double exponential surge generator.

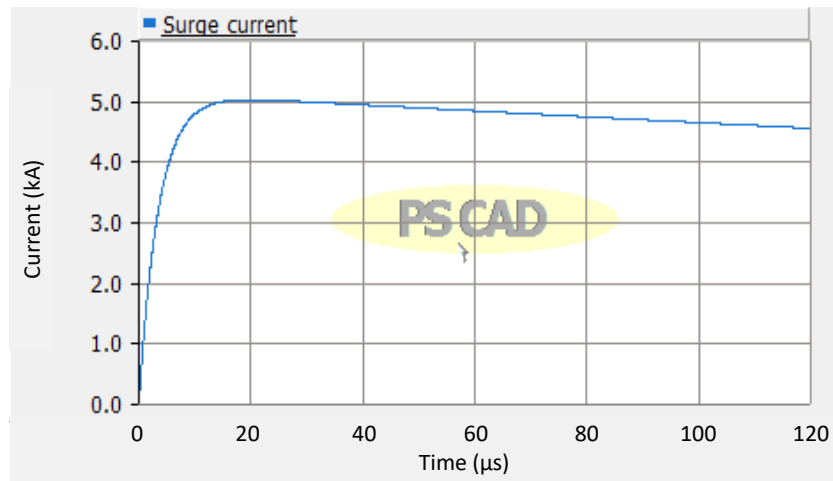

Figure 4.2: 5 kA Lightning Surge of 10/350 μ s Waveform

The output voltage waveform of secondary winding of the DT is shown in Figure 4.3.

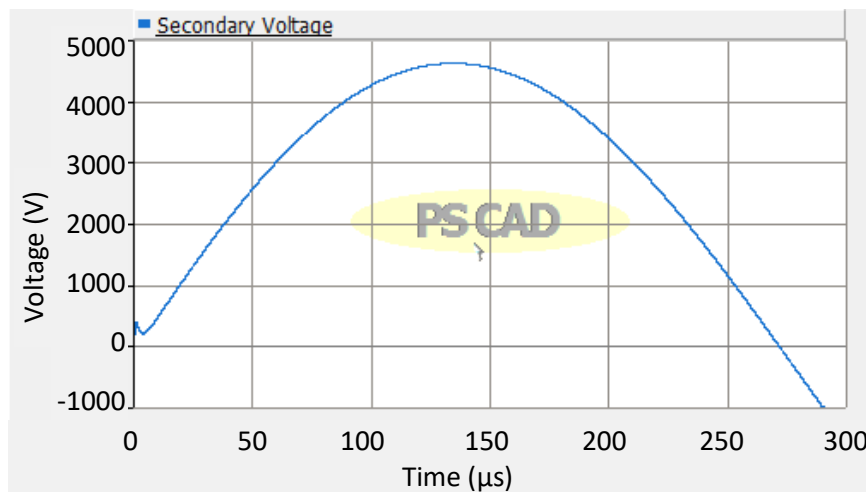

Figure 4.3: Secondary Voltage Waveform at 5 kA Lightning on Primary Side

Sometimes, the MV surge arresters could get disconnected from the DT and no protection is available on primary (MV) side. Then the secondary voltage could rise up to 5,000 V, and that voltage impulse could damage sensitive equipment connected to secondary side of the DT.

Case 2 – 10 kA Lightning Generated from MV Side

Probability of occurrence of 10 kA lightning is 0.9 as per IEC 62305-1: 2010.

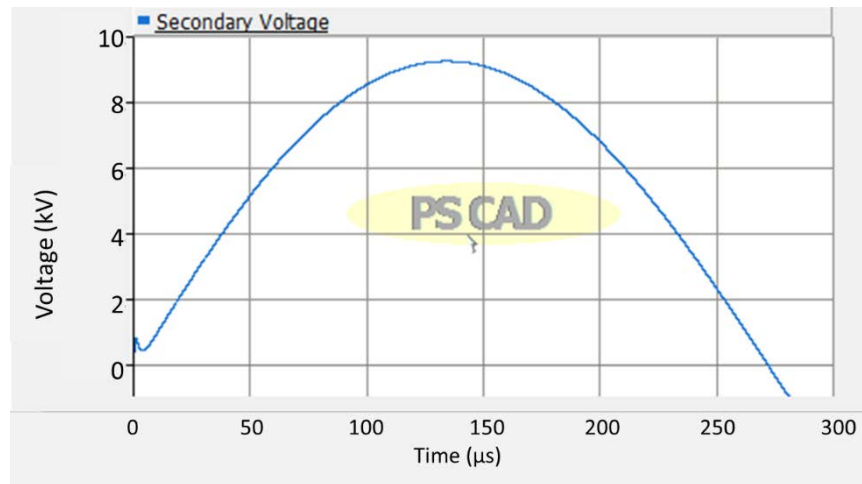

Figure 4.4: Secondary Voltage Waveform at 10 kA Lightning on Primary Side

Case 3 – 40 kA Lightning Generated from MV Side

Probability of occurrence of 40 kA lightning is 0.4 as per IEC 62305-1: 2010.

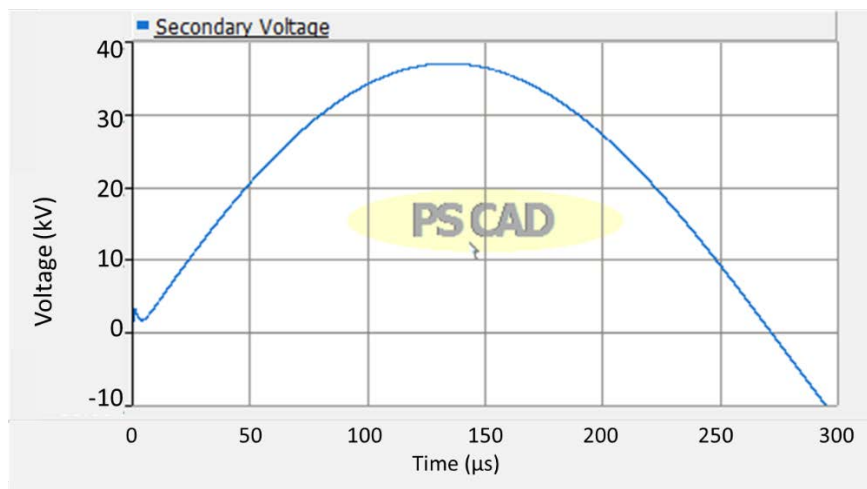

Figure 4.5: Secondary Voltage Waveform at 40 kA Lightning on Primary Side

Figure 4.4 and 4.5 shows that secondary side of the DT is highly affected by lightning surges caused by capacitive coupling of MV and LV windings. Therefore, if the MV protection is not available or malfunctioning, the transformer and LV side consumers are at a high risk. 40 kV voltage impulse at secondary could destroy the PPM which has the BIL of 6 kV.

4.1.2 DT with MV Surge Arrester. Lightning from MV Side

Hubbell 36 kV ($U_c = 29$ kV) arrester parameters are used for modeling. V-I characteristics of the surge arrester is shown in Figure 4.6.

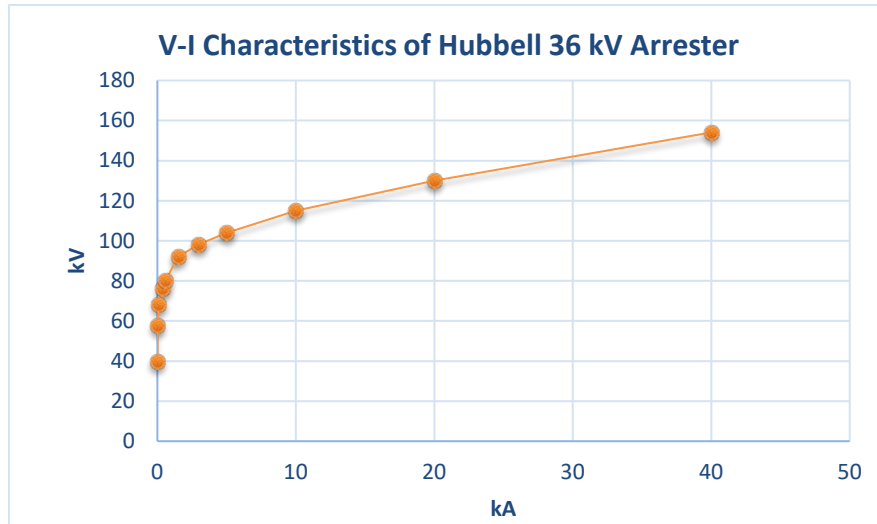

Figure 4.6: V-I Characteristics of Hubbell 36 kV Surge Arrester

Case 1 – 10 kA Lightning Generated from MV Side

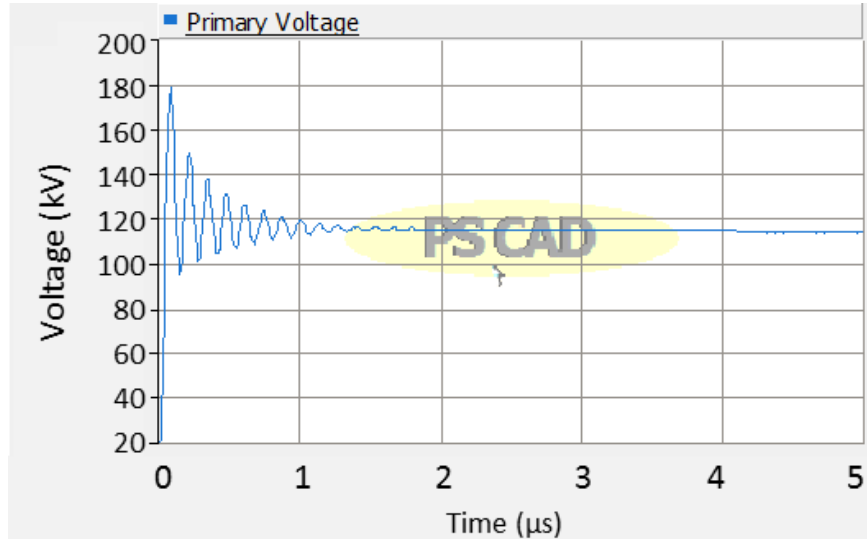

Figure 4.7: Primary Voltage Waveform at 10 kA Lightning on Primary Side

Even though the cutoff voltage of the arrester at 10 kA surge current is around 115 kV, the primary winding voltage has increased to 180 kV because of the inductance of the earth cable of the surge arrester ($1\mu H$ inductance is shown in Figure 4.1).

The output voltage waveform of secondary winding of the DT is shown in Figure 4.8.

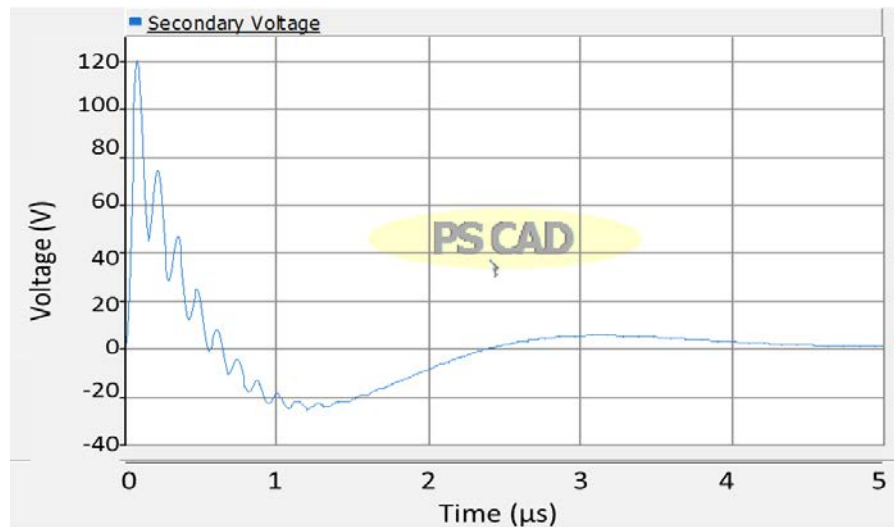

Figure 4.8: Secondary Voltage Waveform at 10 kA Lightning on Primary Side with MV Surge Arrester

When the MV surge arrester was not present, voltage rise of the secondary was 2 kV and with the introduction of MV surge arrester, the secondary voltage impulse has reduced to 120 V, which is safer for the LV side.

Case 2 – 40 kA Lightning Generated from MV Side

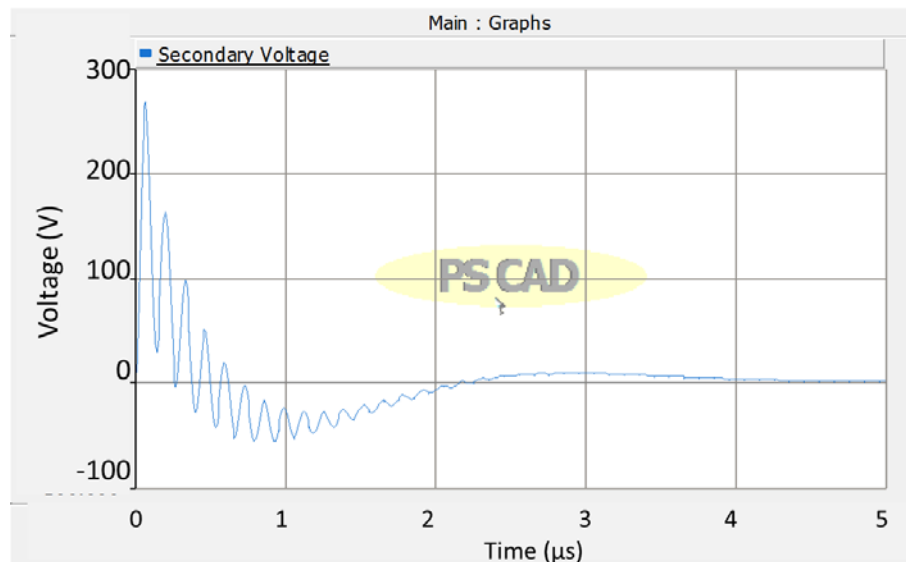

Figure 4.9: Secondary Voltage Waveform at 40 kA Lightning on Primary Side with MV Surge Arrester

4.1.3 DT with MV Surge Arrester. Lightning Generated from LV Side

PSCAD simulation was done with the surge generator connected to secondary side of the DT. Sample load of 82 kVA is connected to the secondary side. Inductance of $1\mu\text{H}$ is used to compensate the inductance of load cables of the DT.

Lightning waveforms of different magnitudes were injected from secondary side and the voltage waveforms were analyzed to check the impact on LV side

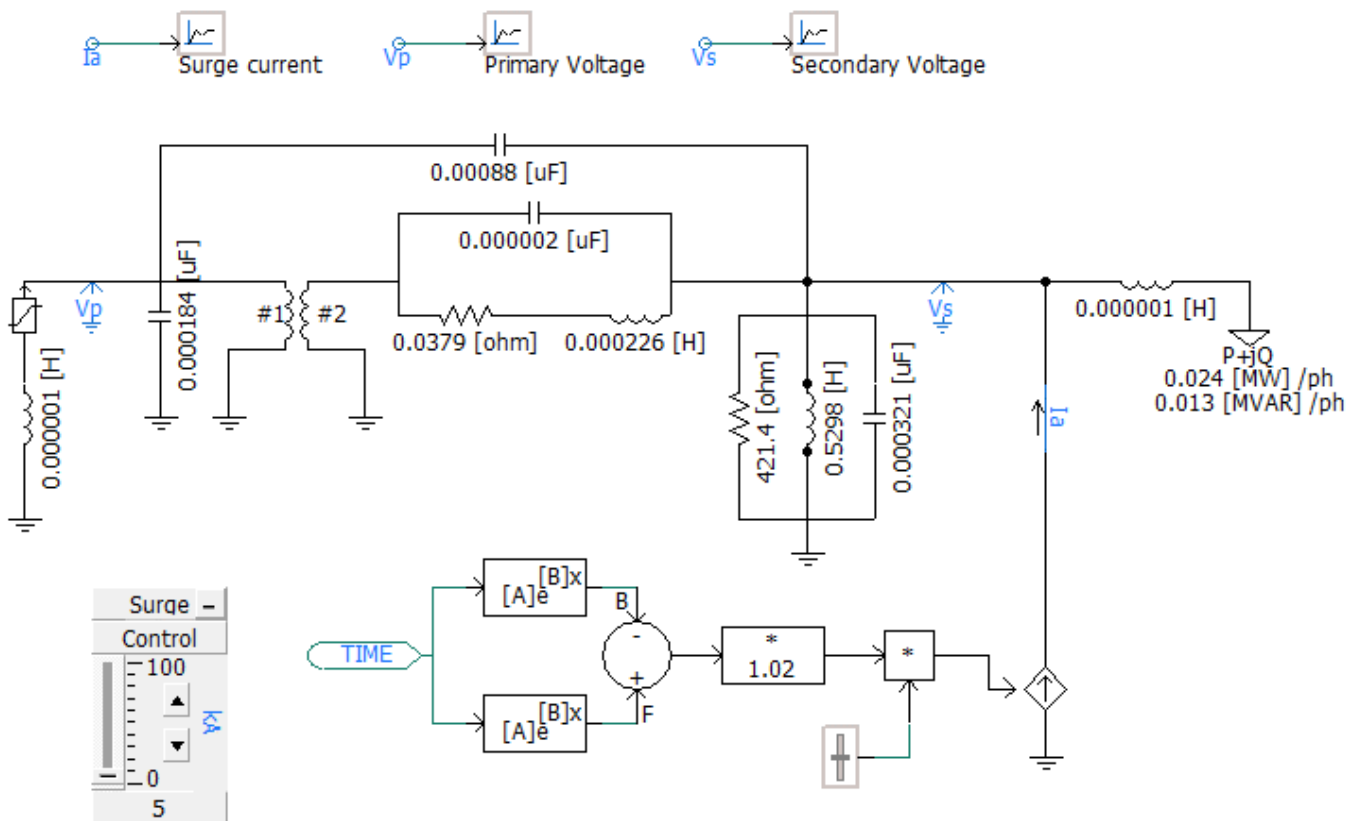

Figure 4.10: PSCAD Model of Distribution Transformer with Surge Generator Connected to LV side with MV Surge Arrester

This scenario could happen when the occurrence of direct lightning strike on load cables or distribution feeders, or an induced surge caused by direct lightning strike on to a surrounding structure or ground.

Ground potential rise will deviate the floating point and eventually cause an increase in phase voltage.

Case 1 – 5 kA Lightning Generated from LV Side

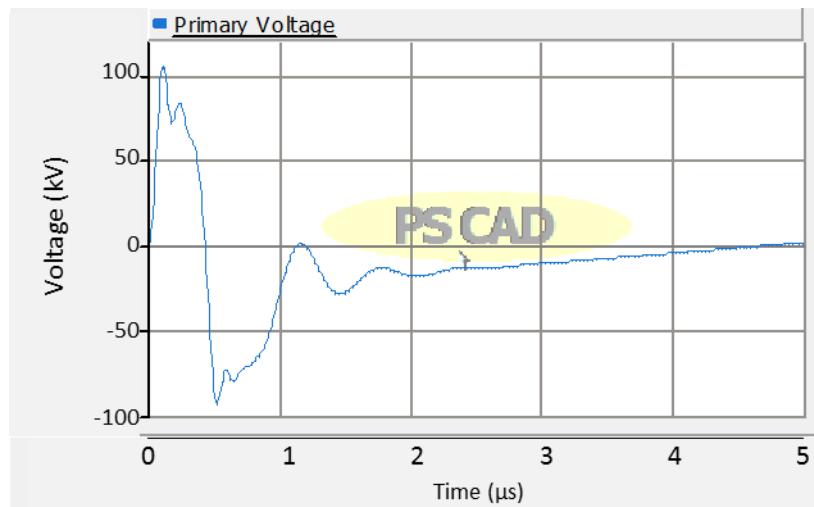

Figure 4.11: Primary Voltage Waveform at 5 kA Lightning on Secondary Side with MV Surge Arrester

Primary winding voltage has gone up due to capacitive coupling of MV and LV windings, and cut off by the SPD in MV side.

The output voltage waveform of LV winding of the DT is shown in Figure 4.12.

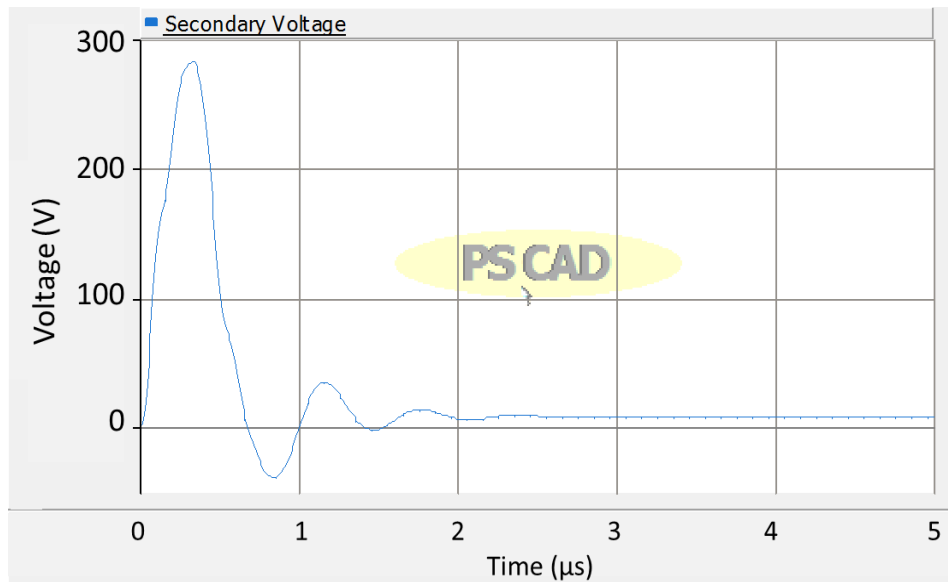

Figure 4.12: Secondary Voltage Waveform at 5 kA Lightning on Secondary Side with MV Surge Arrester

Secondary voltage has been increased by lightning and the combination of power frequency and lightning induced voltage will be higher than this.

Case 2 – 10 kA Lightning Generated from LV Side

Output voltage waveform of the primary winding at the occurrence of 10 kA lightning on secondary side is shown in Figure 4.13.

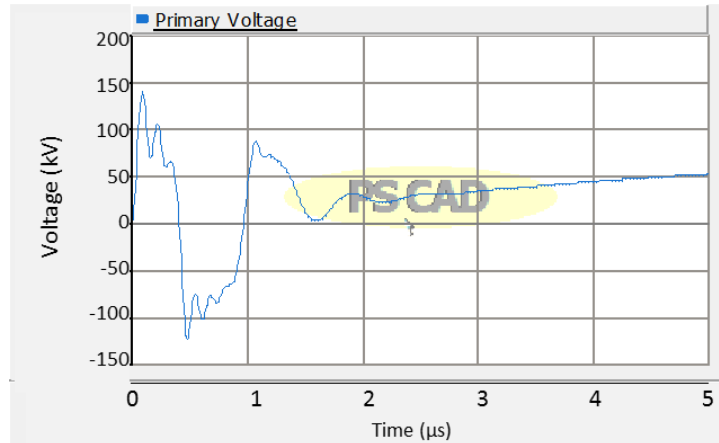

Figure 4.13: Primary Voltage Waveform at 10 kA Lightning on Secondary Side with MV Surge Arrester

Primary winding voltage has gone up due to capacitive coupling of MV and LV windings, and cut off by the SPD in MV side. BIL of the transformer is 170 kV and the primary voltage has increased up to 140 kV.

The output voltage waveform of secondary winding of the DT is shown in Figure 4.14.

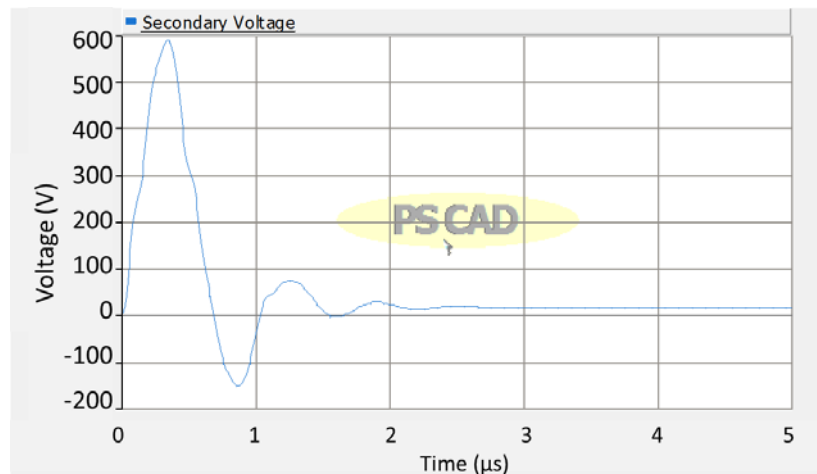

Figure 4.14: Secondary Voltage Waveform at 10 kA Lightning on Secondary Side with MV Surge Arrester

Now the secondary voltage has increased up to 600 V and that could be harmful to the sensitive electronics attached to LV side.

Case 3 – 40 kA Lightning Generated from LV Side

Output voltage waveform of the primary winding at the occurrence of 40 kA lightning on secondary side is shown in Figure 4.15.

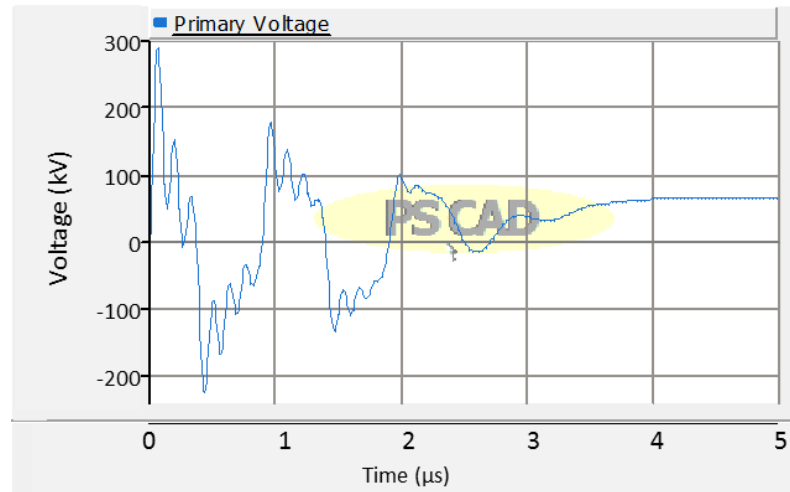

Figure 4.15: Primary Voltage Waveform at 40 kA Lightning on Secondary Side with MV Surge Arrester

Primary winding voltage has exceeded the BIL of transformer and transformer failure or serious damage to the transformer insulation could happen in this case.

The output voltage waveform of LV winding of the DT is shown in Figure 4.16.

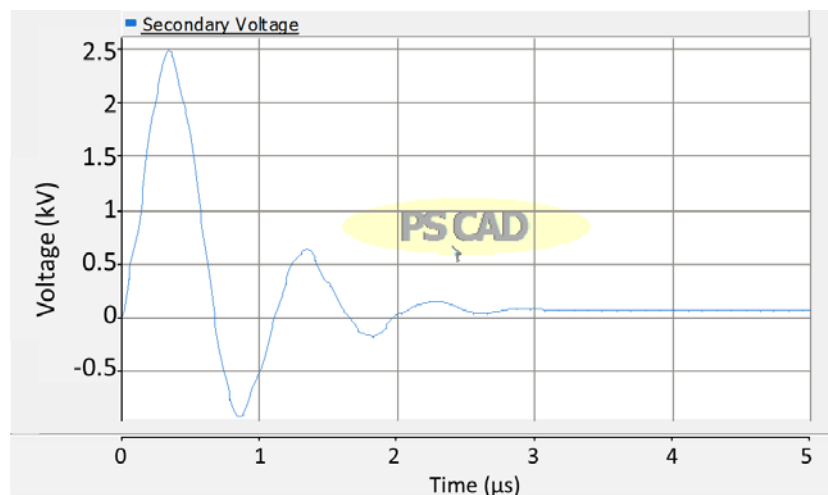

Figure 4.16: Secondary Voltage Waveform at 40 kA Lightning on Secondary Side with MV Surge Arrester

Secondary voltage has increased up to 2.5 kV and that could be harmful to the DT winding and LV consumers as well.

3 scenarios simulated above shows that when the lightning current is more than 10 kA, the LV side of the DT is in danger irrespective of the side where lightning surge injected to the system. Therefore it is clear that LV side surge protection is necessary to protect the PDS and consumers connected.

4.1.4 DT with MV and LV Surge Arresters. Lightning Generated from LV Side

LV surge arrester was added to the DT to simulate the impacts when the DT is protected from both MV and LV sides.

ABB LOVOS, 440 V ($I_n = 10$ kA) arrester parameters were used to model the LV surge arrester in PSCAD. $1\mu\text{H}$ inductance for LV surge arrester earth cable and $20\mu\text{H}$ inductance for the load cables has been modeled.

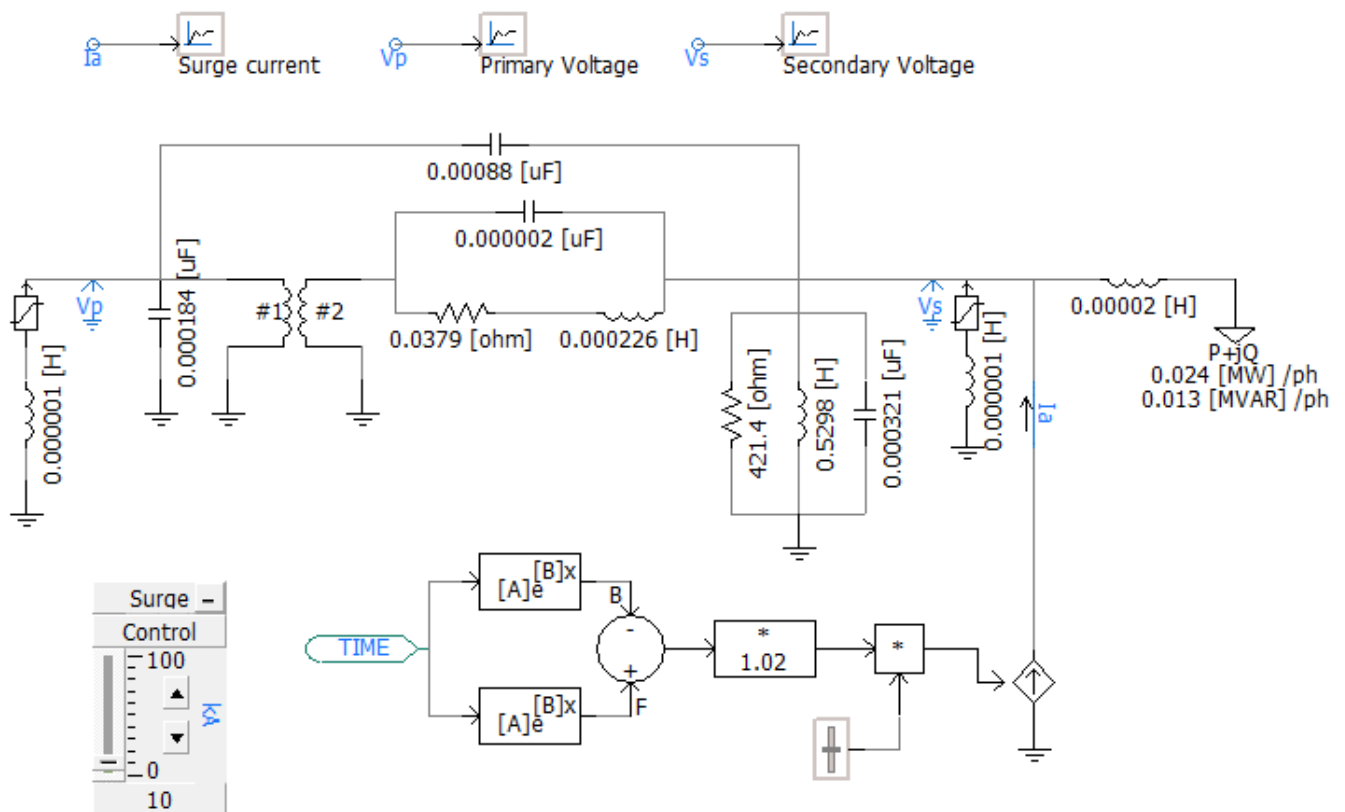

Figure 4.17: PSCAD Model of Distribution Transformer with Surge Generator Connected to LV side with MV and LV Surge Arresters

Case 1 – 5 kA Lightning Generated from LV Side

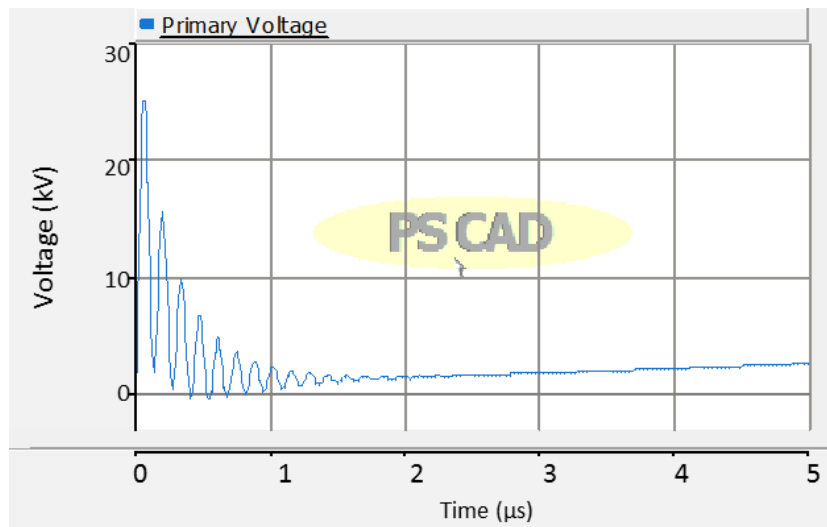

Figure 4.18: Primary Voltage Waveform at 5 kA Lightning on Secondary Side with MV and LV SPDs

Primary winding was not affected by the lightning as both sides of the DT are protected with SPDs.

The output voltage waveform of LV winding of the DT is shown in Figure 4.19.

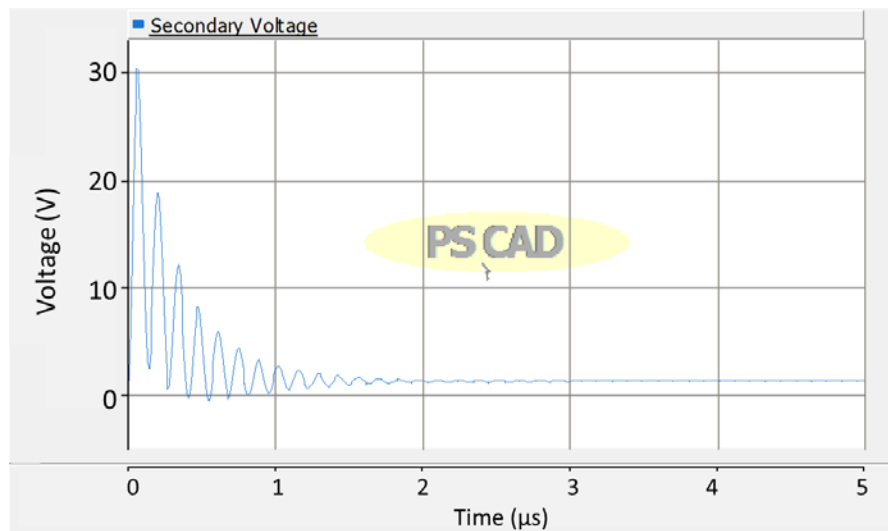

Figure 4.19: Secondary Voltage Waveform at 5 kA Lightning on Secondary Side with MV and LV SPDs

Surge current was diverted to ground by the surge arrester and the DT is not affected by the lightning.

Case 2 – 10 kA Lightning Generated from LV Side

Output voltage waveform of the primary winding at the occurrence of 10 kA lightning on secondary side is shown in Figure 4.20.

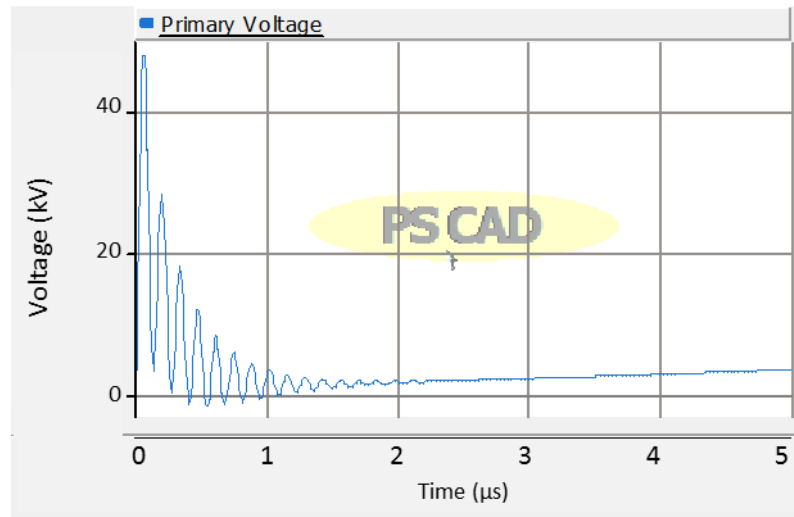

Figure 4.20: Primary Voltage Waveform at 10 kA Lightning on Secondary Side with MV and LV SPDs

Primary winding voltage has gone up, but limited by the SPDs. Hence no damage to the DT or equipment.

The output voltage waveform of secondary winding of the DT is shown in Figure 4.21

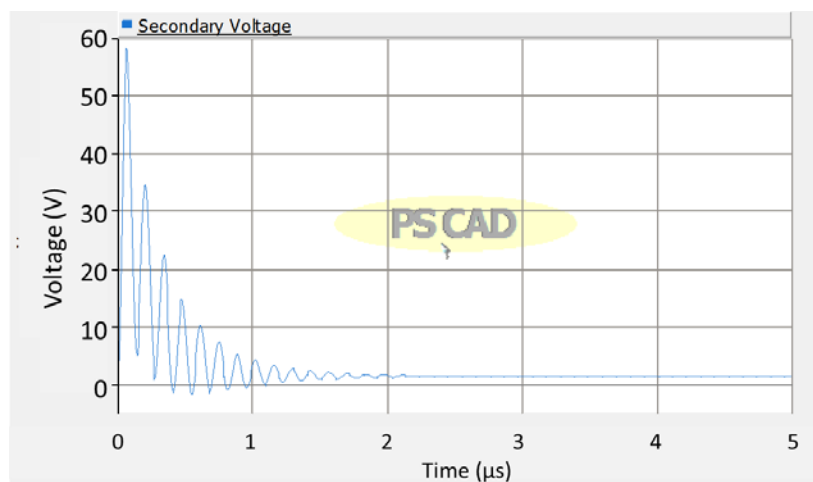

Figure 4.21: Secondary Voltage Waveform at 10 kA Lightning on Secondary Side with MV and LV SPDs

Now the secondary voltage is limited to 60 V and that would not do any harm to the system.

Case 3 – 40 kA Lightning Generated from LV Side

Output voltage waveform of the primary winding at the occurrence of 40 kA lightning on secondary side is shown in Figure 4.22.

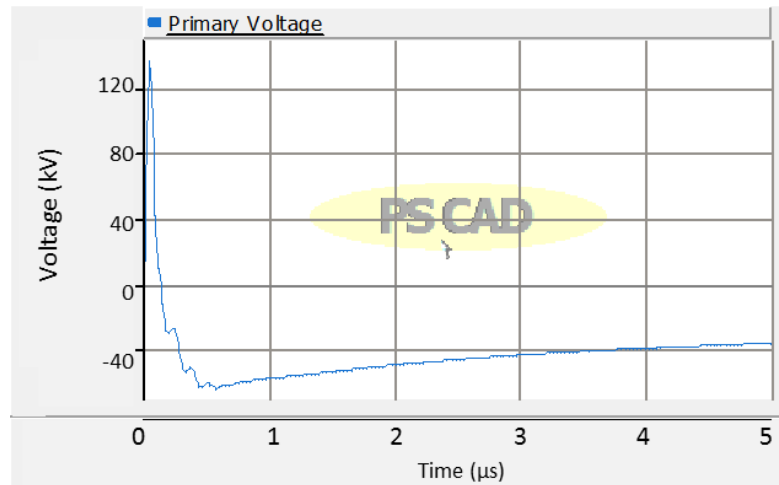

Figure 4.22: Primary Voltage Waveform at 40 kA Lightning on Secondary Side with MV and LV SPDs

Primary winding voltage has not exceeded the BIL of transformer and transformer and the MV system is protected.

The output voltage waveform of LV winding of the DT is shown in Figure 4.23.

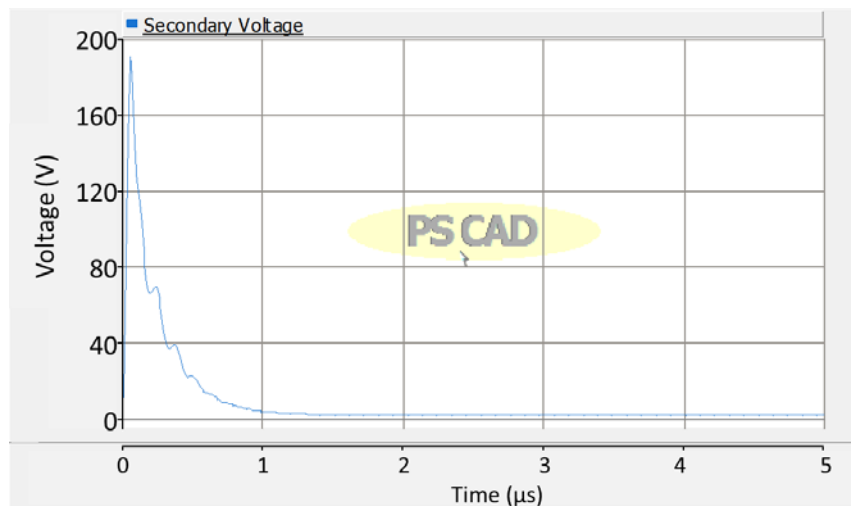

Figure 4.23: Secondary Voltage Waveform at 40 kA Lightning on Secondary Side with MV and LV SPDs

Secondary voltage has increased up to 180 V and limited under the safety margin. Surge current is effectively diverted by the SPD in LV side.

4.2 Observations of PSCAD Simulation

It was clearly visible that the LV side surge protection can effectively reduce potential disturbances generated by lightning surges at MV and LV sides. Therefore, following conclusions were derived from the above scenarios.

- ✓ Lightning surges on primary side of the transformer has considerable impact on the secondary side electrical parameters.
- ✓ Capacitive coupling between HT and LT windings induce voltage impulses on secondary side even when a MV arrester is present.
- ✓ If the MV arrester is damaged or unearthed, the whole substation could be damaged by average lightning surges.
- ✓ By adopting LV side surge protection, the impact of lightning surges on secondary side (from Load end) could be minimized.
- ✓ LV side transformer protection is required to protect transformer, other substation equipment and consumer loads from lightning surges.

5 DESIGN OF LV SURGE PROTECTION SYSTEM

5.1 Power Distribution Substation Model

In this chapter the behavior of the LV side parameters of the PDS is studied and an algorithm is developed to cover all the steps in designing and selecting the best protection scheme for the LV side of the power distribution substation. Then the main parameters of the protection system were determined in relation to the LV distribution network parameters of CEB distribution network.

The typical power distribution substation of CEB consist of distribution transformer, MV surge protection system, earthing arrangements for transformer and surge arresters, programmable polyphase meter (only for the bulk consumers whose contract demand is more than 42 kVA), load cables of LV bare line Aluminum or Bundled conductor distribution feeders serving domestic consumers.

Figure 5.1 shows the schematic diagram of the typical distribution substation system.

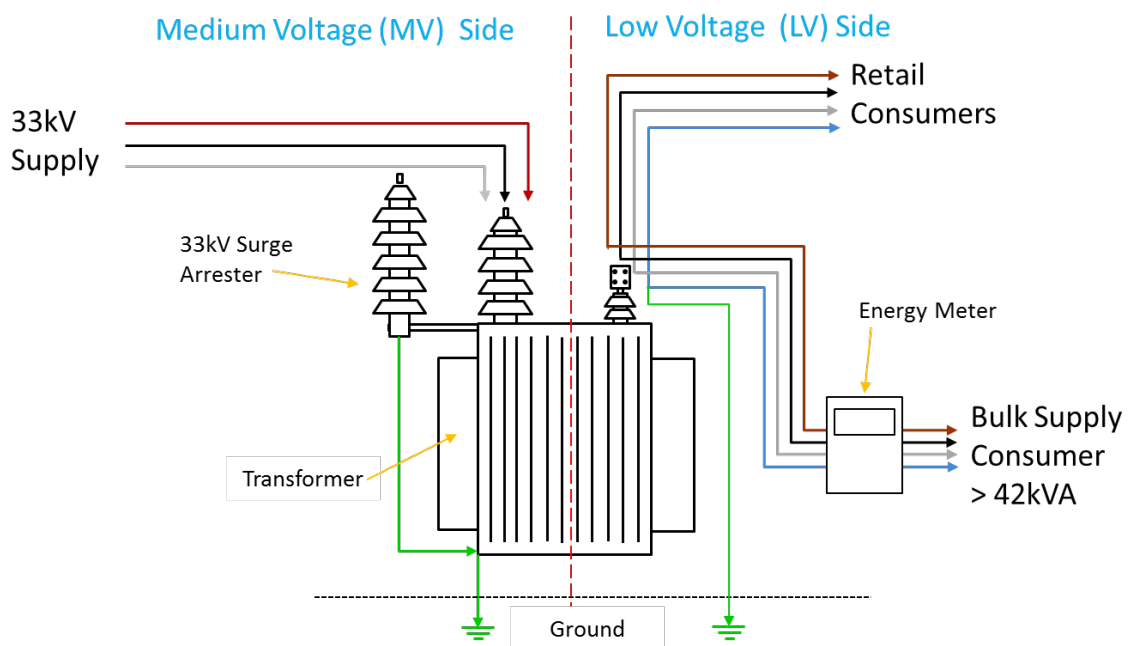

Figure 5.1: Typical Power Distribution Substation

5.1.1 Behavior of the LV side Parameters During a Lightning Strike

Direct or Induced Lightning Surge on MV Side

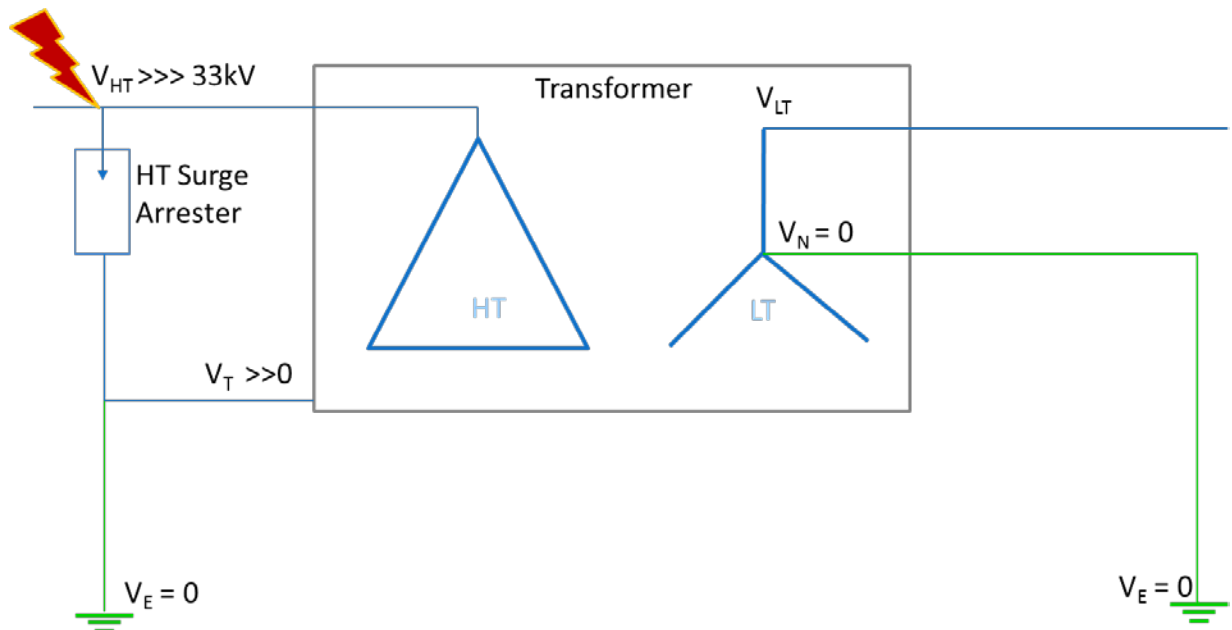

Figure 5.2: Single Line Diagram of PDS during Lightning on MV Side

- When a direct or induced lightning coming from MV side, the voltage of the live terminal of the surge arrester V_{HT} is the combination of residual voltage of the surge arrester and the voltage rise of the earth cable.
- However, the transformer body is connected to the earthing terminal of the arrester and therefore, the transformer tank is also at a higher voltage (V_T) compared to the ground potential V_E .
- Because of the capacitive coupling, voltage impulse is transferred to the LV winding and relative to the voltage of the floating point, the LV terminal voltage (V_{LT}) could go up to kilo Volt range.
- In the case of surge arrester earth cable is not connected to the transformer body, the V_T will be at 0 potential and the voltage difference between MV terminal and transformer body will be very high. This can cause primary winding to body flashover.

Direct or Induced Lightning Surge on LV Side

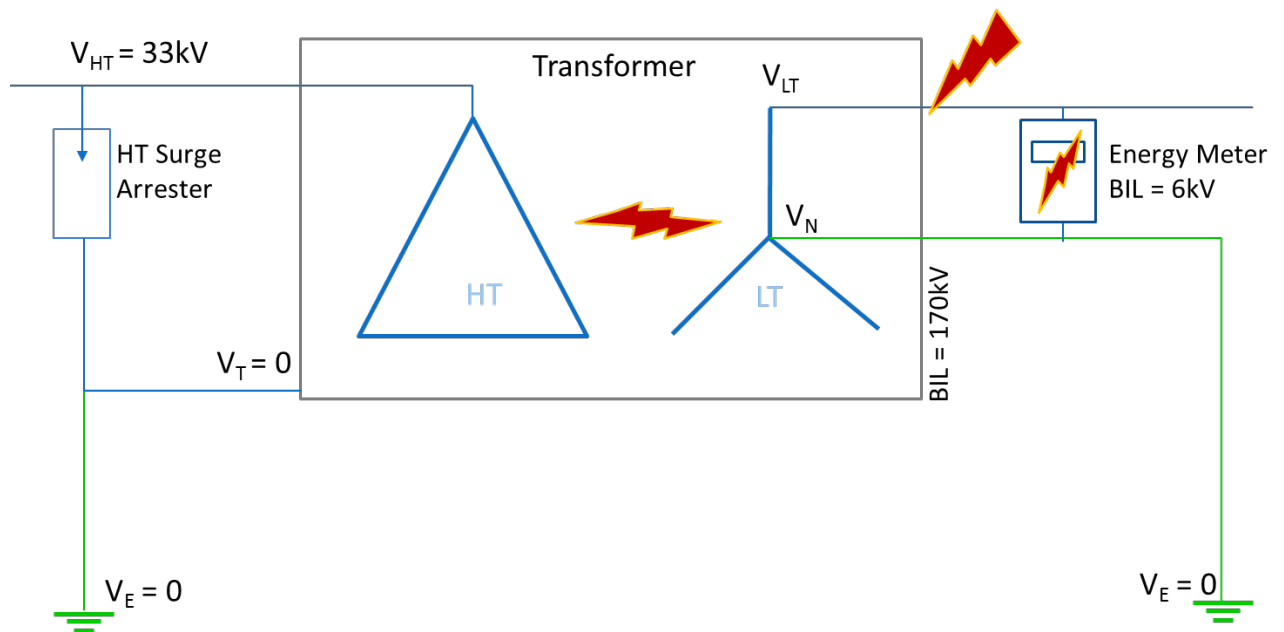

Figure 5.3: Single Line Diagram of PDS during Lightning on LV Side

- When a direct or induced lightning coming from LV side, the voltage V_{LT} increases rapidly putting the LV side consumers in to a risk.
- Because of the capacitive coupling, voltage impulse is transferred to the MV winding and flashover between MV winding and transformer body could occur. This will cause damage to the oil insulation and prolonged exposure will eventually cause insulation failure of the transformer.
- The PPM connected to LV load cable will sense this voltage rise in LV side could be damaged if the induced voltage is higher than 6 kV.
- In some cases, single phase domestic energy meters are also affected by the surge currents in LV distribution feeders. If any protection device is connected to the LV side, most of these damages can be minimized by diverting the surge currents to the ground.

5.1.2 Lightning Protection Zones (LPZ) of PDS

According to IEC 62305:2010 several lightning protection zones are defined to protect structures from lightning.

- LPZ 0_A zone where the threat is due to the direct lightning flash and the full lightning electromagnetic field. The internal systems may be subjected to full or partial lightning surge current.
- LPZ 0_B zone protected against direct lightning flashes but where the threat is the full lightning electromagnetic field. The internal systems may be subjected to partial lightning surge currents.
- LPZ 1 - Zone where the surge current is limited by current sharing and by isolating interfaces and/or SPDs at the boundary.
- LPZ 2, ..., n - Zone where the surge current may be further limited by current sharing and by isolating interfaces and/or additional SPDs at the boundary. Additional spatial shielding may be used to further attenuate the lightning electromagnetic field.

Identification of lightning protection zones relevant to the distribution substations is shown in Figure 5.4.

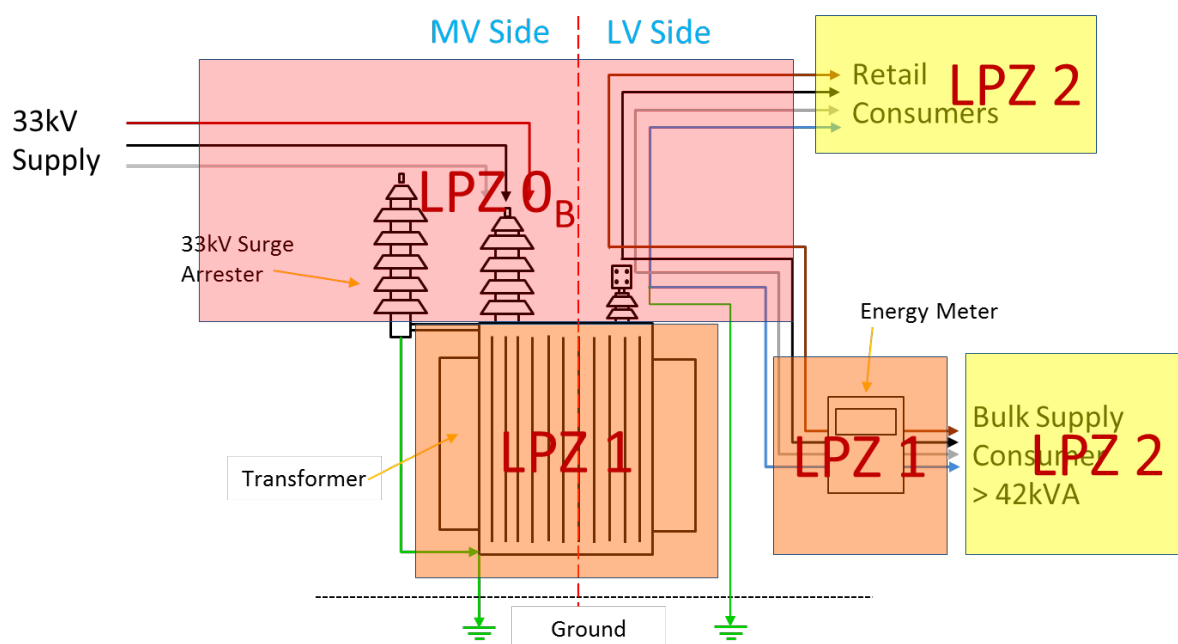

Figure 5.4: Lightning Protection Zones in PDS

5.1.3 LV Protection Design Algorithm

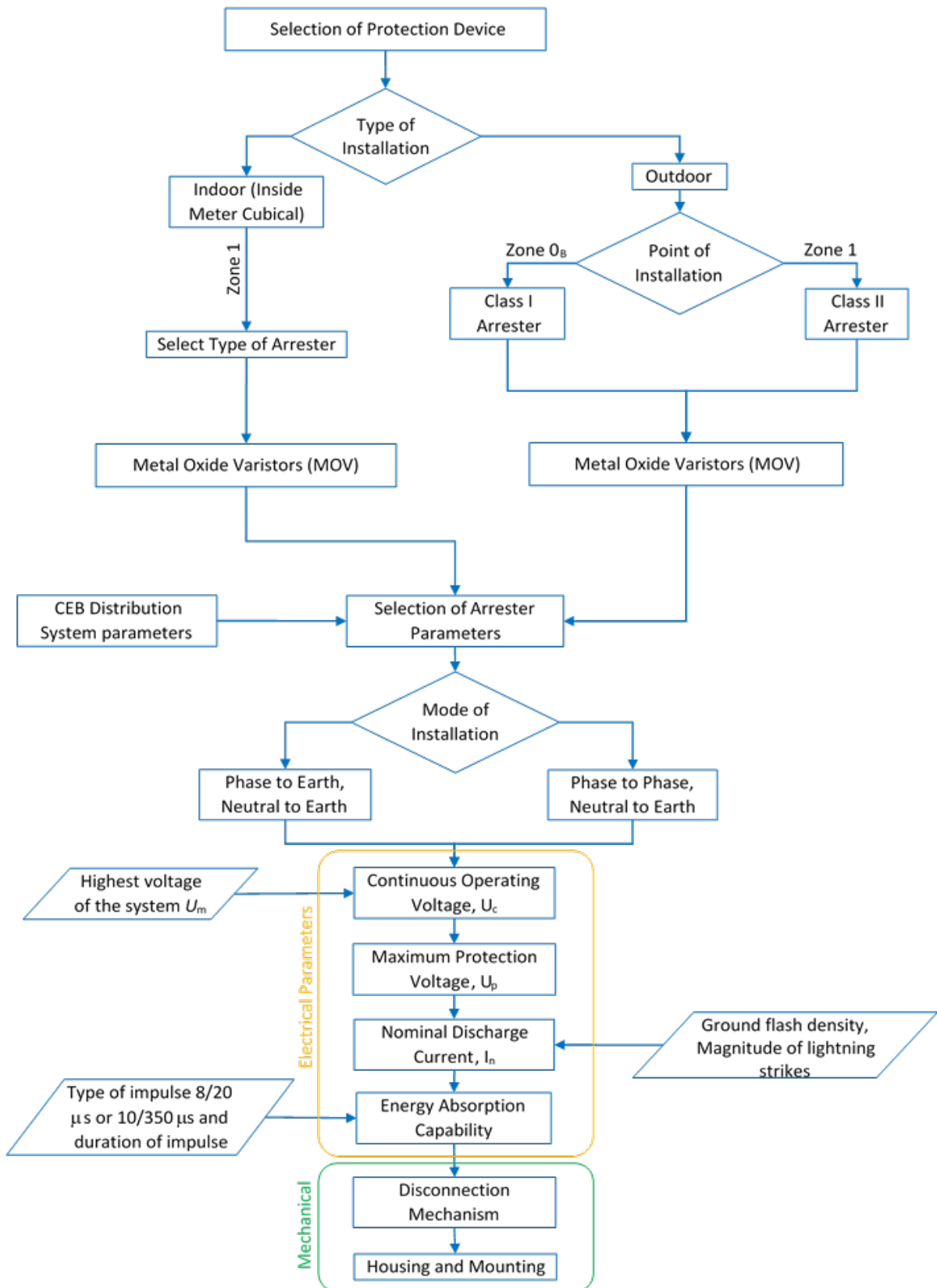

Figure 5.5: LV Protection Design Algorithm

5.2 Design of LV Surge Protection System for PDS

5.2.1 Design Principles – LV Surge Protection System

- 1) Terminals of LV bushings of the transformer are in LPZ 0_B and needs to be equipped with SPDs. 4 bushings are available in the transformer LV side for 3 phases and the neutral. These bushings have flags with four connection holes to connect the load cables.
- 2) PPM Energy meter is at LPZ 1. Energy meter should be protected with SPDs only if the SPDs at LPZ 0_B could not protect the energy meter or if the severity and frequency of the lightning strikes are higher. Lightning surge propagates to the PPM through the voltage tapings connected to the load cables to measure the voltage of three phases.
- 3) Transformer LT winding is at LPZ 1. It should be protected by the SPDs at LPZ 0_B (SPDs at HV and LV bushings).
- 4) Bulk and Retail consumers are at LPZ 2 with respect to the PDS. Consumer side should be protected with SPDs or filters only if the SPDs at LPZ 0_B and LPZ 1 could not protect them from surge currents generated from DT side.

Two main components of the substation to protect are; Transformer and the PPM. Hence the protection devices should be installed closer to those components to minimize the arrester lead length. Proposed installation points and the lightning protection zones they belong are as follows.

- ✓ Terminals of LV bushings of Transformer – Zone 0_B
- ✓ Voltage input of Energy meter – Zone 1

According to the lightning protection zone concept defined in IEC 62305-1:2010 and the protection class definition of IEC 61643-11:2011.

- ✓ Arresters installed at the terminals of LV bushings of Transformer should be Class I.
- ✓ Arresters installed voltage input of energy meter should be Class II.

5.2.2 Design Principles –Protection System Parameters

Continuous operating Voltage of SPD (U_c)

The maximum U_c should be selected as follows where U_m is the system highest voltage of the LV side.

Reference; IEC 62305-4:2006 Protection against lightning - Part 4: Electrical and electronic systems within structures.

$$U_c \geq 1.1 \times U_m / \sqrt{3} \quad \text{For } \emptyset - E, N - E, \emptyset - N \text{ installation}$$

$$U_c \geq 1.1 \times U_m \quad \text{For } \emptyset - \emptyset \text{ installation}$$

$$U_m = 400 V$$

$$U_c \geq 1.1 \times 400 / \sqrt{3} \cong 254 V \quad \text{For } \emptyset - E, N - E, \emptyset - N \text{ installation}$$

$$U_c \geq 1.1 \times 400 \cong 440 V \quad \text{For } \emptyset - \emptyset \text{ installation}$$

Maximum Protection Voltage of SPD (U_p)

Maximum voltage appears across its terminals during the flow of nominal discharge current through the SPD, which is selected from a list of preferred values provided by manufacturer.

This value shall be greater than the highest value of the measured limiting voltages.

$$U_t \geq 2U_p \quad U_t \text{ is the maximum allowed voltage between terminals [7]}$$

$$U_t = 6 kV \quad \text{For 33/400 kV transformer LV side and for 3 phase PPM}$$

$$\therefore U_p \leq 6/2 kV$$

$$U_p \leq 3 kV$$

For different type of arresters and different manufacturers the U_p / U_c ratio remains in 3-5 limits. The lower the U_p / U_c ratio, the greater the insulation protective margin of protected equipment.

Nominal Discharge Current (I_n) 8/20 μ s

Maximum Discharge Current (I_m) 8/20 μ s

Over 90% of direct lightning strokes on lines, the currents flowing through arresters are less than 10 kA.

$$I_n = 5 \text{ kA} - 10 \text{ kA} \text{ and } I_m = 25 \text{ kA} - 40 \text{ kA}$$

Considering the high isokeraunic levels (90 -100) and higher ground flash density (15 – 20 flashes/km²), it is recommended to have higher ratings for I_n and I_m .

$$I_n = 10 \text{ kA}$$

$$I_m = 40 \text{ kA}$$

5.2.3 Selection of Protection System

Design algorithm and the parameters derived in the previous section was used to select the suitable protection device. Market analysis has been done to find the products available in the local market and the international market following features were considered when selecting the SPD.

- Should be able to install at outdoors
- Should withstand tropical environmental conditions
- Should be in compact size to be installed at transformer LV bushing
- Technical specification should match with all the above electrical parameters
- Should be easily installable and replaceable
- Should have a disconnection mechanism, which will isolate the SPD at the event of SPD failure
- Cost of the SPD should be affordable (less than the cost of replacing the PPM)

Comparison of LV side SPDs available in the market is shown below.

Table 5-1: Comparison of LV side SPDs

Feature	ABB	AK Power	Ensto	Tyco - Raychem	G.K. Power	IzoElektro
Make	Poland	Australia	Finland	Ireland	Thailand	Slovenia
SPD type	limiting voltage, Polymer housed with disconnecting device located internally	limiting voltage, Polymer housed fully encapsulated Varistor	limiting voltage, UV radiation resistant and moisture proof housing. Can be installed only on insulated conductors	limiting voltage, weatherproof polymer housing with disconnecting device located internally	limiting voltage, gapless MOV with polymeric housing with automatic disconnector	limiting vltage, ZnO, Silicon rubber housing with automatic disconnector
Standards	acc. to IEC61643-1: 2005 - class II acc. to DIN/VDE 0675/6 - A	AS 1307.2 1996 IEC 99-4 distribution class	acc. IEC 61643-1 - class II DIN/VDE 0675/6 c - A	acc. IEC 61643-1 - class II	acc. IEC 61643-1 - class II	acc. IEC 61643-1 - class II DIN/VDE 0675/6 c - A
Test classification	acc. to IEC61643-1: 2005 - class II tests		IEC 61643-1,1998-02	IEC 61643-1 + Amd.1 and EN 61643-11	IEC 61643-1	EN 61643-11:2002 - 73/23 EEC
For system voltages	up to 1 kV	up to 500 V	up to 660 V	up to 440 V	up to 480 V	up to 585 V
Location	outdoor and indoor	outdoor	outdoor	outdoor	outdoor	outdoor and indoor
SPD disconnecting device	located internally	N/A	N/A	located internally	located internally	located internally
Ambient temperatures	from -40°C to +70°C		from -60°C to +70°C	from -40°C to +70°C		from -40°C to +85°C
Nominal discharge current (In) 8/20µs	5 or 10 kA		5 or 10 kA	10 kA	5 kA	15 kA
Maximum discharge current(I _m)8/20µs	25 or 40 kA		25 kA or 40 kA	40 kA	10 kA	40 kA
Limiting discharge current	40 kA or 65kA 4/10 µs	65kA 4/10 µs	40 kA or 65 kA 4/10 µs	100 kA 4/10 µs		
Voltage protection level (Up)	up to 5.8 kV at I _{max} up to 3.4 kV at long lasting surge (2000 ns)	up to 2.2 kV	up to 2.7 kV	up to 1.6 kV		up to 2.24 kV
Continuous operating voltage (U _c)	280, 440, 500, 660, 800, 1000 V AC (effective value)	280, 400 V	280, 440, 660 V AC	280, 440 V AC	480 V	275, 350, 440, 585 V
Energy absorption capability (per kV)	4, 5 or 7 kJ		.7 to 2.6 kJ	4.1 kJ		2.45 kJ or 3.2 KJ
Short-circuit withstand	3 kA					
Maximum residual voltage at I _n				1.8 kV (with 15cm lead)	2 kV	
Frequency	up to 62 Hz		up to 62 Hz	up to 62 Hz		
Price in LKR					6,000	
Image						

From the above table, the ABB surge arrester was selected as the most suitable SPD for LV surge protection of power distribution substations. Characteristics of the ABB LOVOS 10 surge arrester is shown below.

Table 5-2: Characteristics of ABB LOVOS 10 Surge Arrester

SPD type	limiting voltage
Number of terminals	one
SPD type (acc. to IEC 61643-1;2005)	Class II
SPD type (acc. to DIN/VDE 0675/6)	A
Test classification	acc. to IEC 61643-1;2005 - class II tests
For system voltages	up to 1 kV
Location	Outdoor and indoor
Accessibility	Inaccessible (out of reach)
Method of installation	Permanent (name plate "downwards")
SPD disconnecting device	located internally
Ambient temperatures	from -40°C to +70°C
Protection degree	IP 06 for standard execution IP 66 with insulated accessories
Nominal discharge current I_n 8/20μs	5 or 10 kA (peak value)
Maximum discharge current I_{max} 8/20 μ s	25 or 40 kA (peak value)
Limiting discharge current*	40 kA or 65kA 4/10 μs
Voltage protection level U_p	acc. to guaranteed data table
Continuous operating voltage U_c	280, 440, 500, 660, 800, 1000 V AC (effective value)
Energy absorption capability**	4, 5 or 7 kJ / kV U_c
Short-circuit withstand	3 kA
Frequency	up to 62 Hz
Total creepage distance	62 mm

The active element of this surge arrester is a Metal Oxide Varistor. Surge arrester is equipped with a disconnecting device, that disconnects the arrester from the system if it is damaged as the result of overvoltage of too high energy or inadmissible voltage increase in the system. If such a situation occurs, then the bottom terminal of the disconnecting device is ejected by the spring inside. This terminal remains suspended on an insulation string. Advantages of ABB LOVOS 10 surge arrester are as follows.

- Easy installation and replacement
- Disconnecting device act as a damage indicator as well
- Large choice of accessories suitable for different type of installations
- Hydro phobic casing resistant to UV radiation and non-flammable
- Maintenance free over the lifetime
- All accessories are made of corrosion resistant materials

Cost of this arrester with live side terminal bracket is Rs. 1,500 including freight charges.

6 IMPLEMENTATION OF LV SURGE ARRESTER INSTALLATION

6.1 Sample Selection of Distribution Substations

Based on PPM burnings and transformer burnings reported in year 2011, 2012 & 2013, a sample of 307 sites were selected for the initial installation. LV surge arrester installation was carried out from year 2013 to year 2016. Around 100 substations were covered per annum. Details of selected implementation sample is shown in table 6-1.

Table 6-1: Sample Selection for Surge Arrester Installation

Year	Based on Meters Burnt	Based on T/Fs Burnt	Total No. of Substations
2013	57	45	94
2014	53	37	86
2015	43	47	82
2016	20	29	45
Total selected Substations	173	158	307

As the total substation population is much larger than the selected sample, a control sample was selected to get a proper evaluation of results. Details of the control sample is shown in table 6-2.

Table 6-2: Selection of Control Sample

Based on Meters Burnt	Based on T/Fs Burnt	Total No. of Substations
90	68	150

When selecting the control sample following points were considered to increase the quality of the results.

- Substations for control sample were selected based on the same principle that the control sample includes substations at which the transformer or the PPM has been burnt during year 2011 to 2013.
- Implementation sample and control sample include substations from similar areas with same isokeraunic level.
- Variation of transformer capacities of the selected substations of both samples are approximately similar and match with the total transformer population.

Justification of selected samples against the total transformer population of DD3 is shown in Figure 6.1.

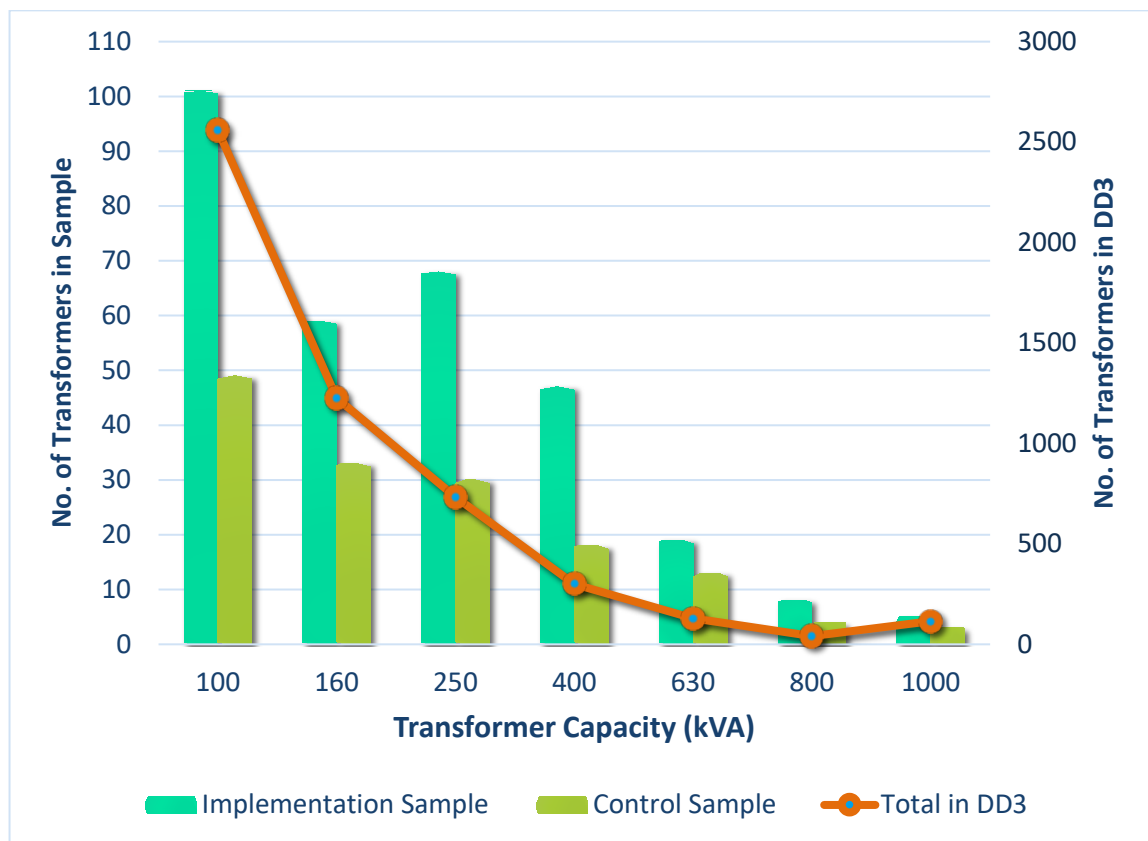

Figure 6.1: Transformers in Selected Sample Against Total in DD3

6.2 Installation of LV Surge Arresters

CEB distribution network is configured as a TT network and the neutral of the transformer is solidly grounded through a 50 mm² multi stranded insulated copper cable. Earth lead of the MV surge arresters are connected to the transformer body and the transformer body is grounded through a 50 mm² multi stranded insulated copper cable. There are two methods in which LV surge arresters can be connected to the DT.

1. Phase – Earth and Neutral – Earth Connection,
2. Phase – Neutral and Neutral – Earth connection.

However, as in TT system the neutral is effectively grounded, there is no need to connect a surge arrester to neutral conductor. Hence, the selected method for installing LV surge arresters in distribution transformers consist only three arresters connected between phase conductors and the earth (in this case, the transformer body). LV surge arrester connection method for CEB distribution system is shown in Figure 6.2.

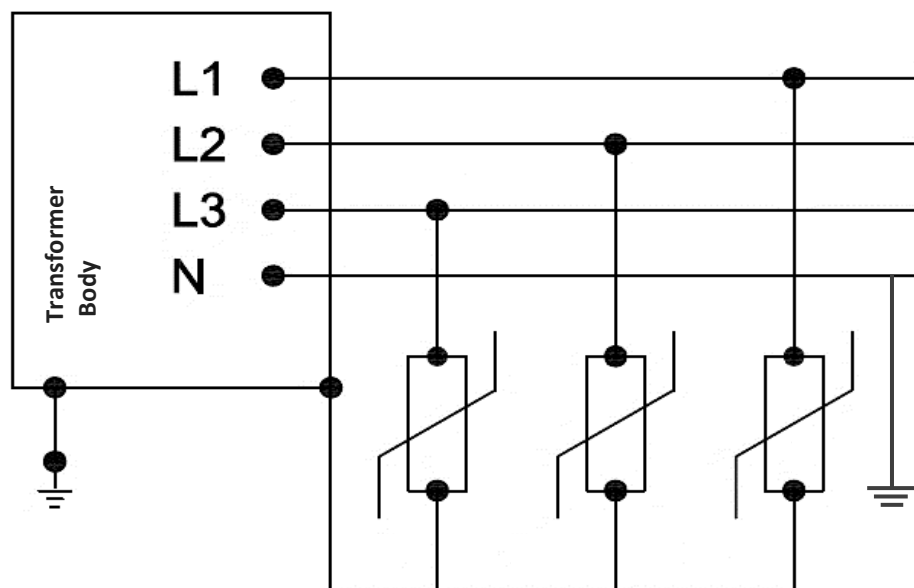

Figure 6.2: LV Surge arrester connection at PDS

From year 2013 to 2016, more than 300 power distribution substations were protected by installing LV surge arresters. During the installation of arresters, the earthing system of the distribution substation was also improved. Some of the installation locations are shown in Figure 6.3.

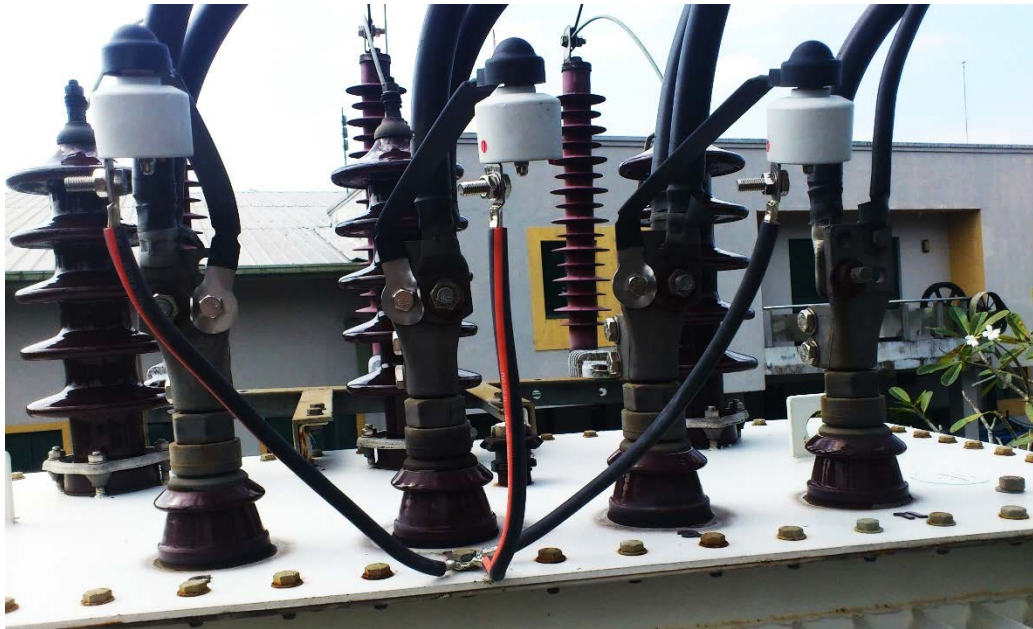

Figure 6.3: LV Arrester Installation at Furgurson Garment, Rathnapura



Figure 6.4: LV Arrester Installation at Tea Small Holdings, Horana



Figure 6.5: Installation at Labugama Water Treatment Plant, Awissawella

At some locations where the frequency and magnitude of the lightning is very high, LV SPDs were installed at PPM voltage tapping points as well.

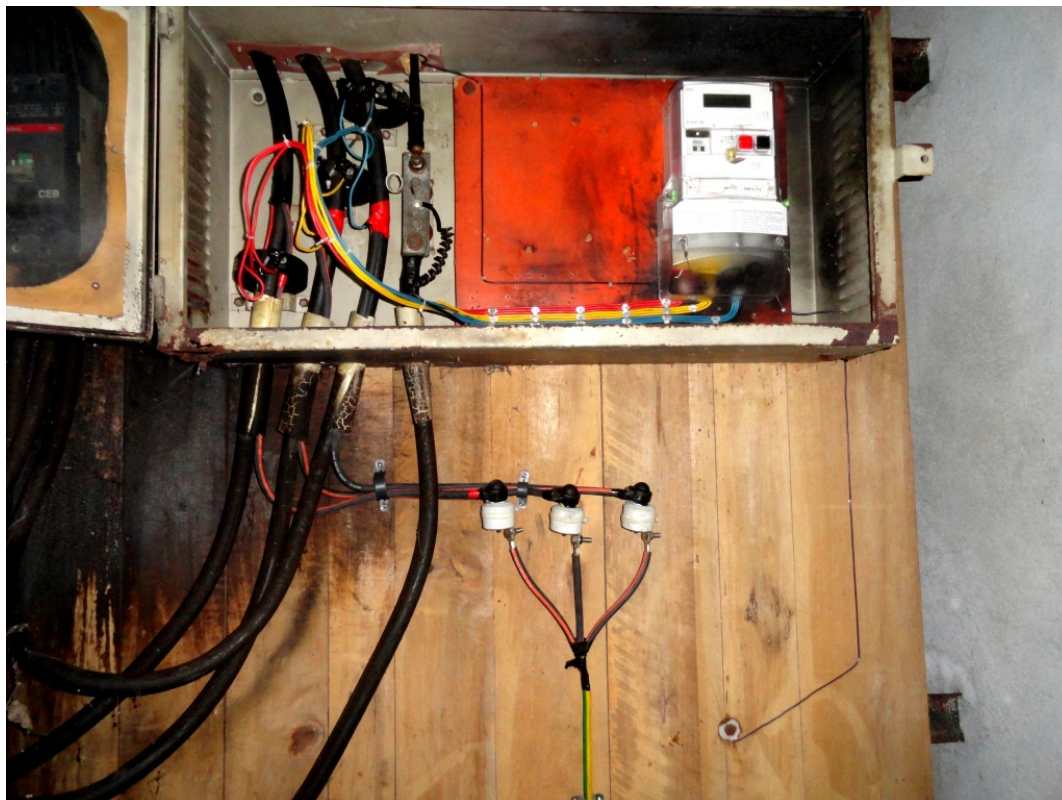

Figure 6.6: Installation on PPM at Sripali, Horana

Status of the LV surge arrester installation project by the end of year 2016 is as follows.

- More than 300 substations in DD3 are protected and installations are going on.
- Installed substations are routinely monitored to check if the arresters are damaged.
- All the substation earths are measured and improved if necessary during the LV arrester installation.
- If meter or transformer burnt in a particular substation, Meter Testing Laboratory of DD3 or Area Engineer will inform us immediately. LV arresters will be installed on those substations giving priority.
- Introduced LV surge arresters to other distribution divisions.

At some locations installed arresters were burnt because of heavy lightning or at the end of effective life of MOV element and disconnected from the system by the thermal disconnection mechanism.



Figure 6.7: Disconnected Arrester at Sripali, Horana

6.3 Results of Field Implementation

Results of the PPM burning after LV surge arrester installation started, during the period from 2013-2016 in implementation sample and control sample.

Table 6-3: PPM burnings after LV Surge Protection

Year	No. of total new Installations	No. of Meters burnt in Implementation sample	No. of Meters burnt in Control sample (Out of 150)
2013	94	3	8
2014	86	12	23
2015	82	16	28
2016	45	9	18
Total	307	40	77
Percentage of Burnt Meters		13 %	51 %

Results of the transformer burning after LV surge arrester installation started, during the period from 2013-2016 in implementation sample and control sample.

Table 6-4: PPM burnings after LV Surge Protection

Year	No. of total new Installations	No. of Transformers burnt in Implementation sample	No. of Transformers burnt in Control sample (Out of 150)
2013	94	1	1
2014	86	7	4
2015	82	10	12
2016	45	6	5
Total	307	24	22
Percentage of Burnt Transformers		8 %	15 %

Comparison of burnt PPMs during the period from 2013 to 2016 clearly shows that there is a reduction of burnt PPMs after the implementation of the LV surge protection system. However, at some months the rate of meter burnings has increased by the frequent heavy lightning strikes. At some sites, meter was burnt even after the installation of surge arresters. The reason could be twofold;

- In some cases, when the arresters are disconnected, the meter will be exposed to lightning surges and subsequent surges could damage the PPM. For some sites, there is no proper mechanism to check whether the surge arrester is in good condition or damaged. Condition of arrester is only verified by the field staff by visiting the site.
- At some sites, ratings of the installed lightning arrester may not impose adequate protection level to withstand the magnitude of the lightning surges attacking that particular area. For those sites, a higher rated arrester should be installed or parallel arresters should be installed to increase the level of protection.

Comparison of burnt PPMs during the period from 2013 to 2016 is shown in Figure 6.8.

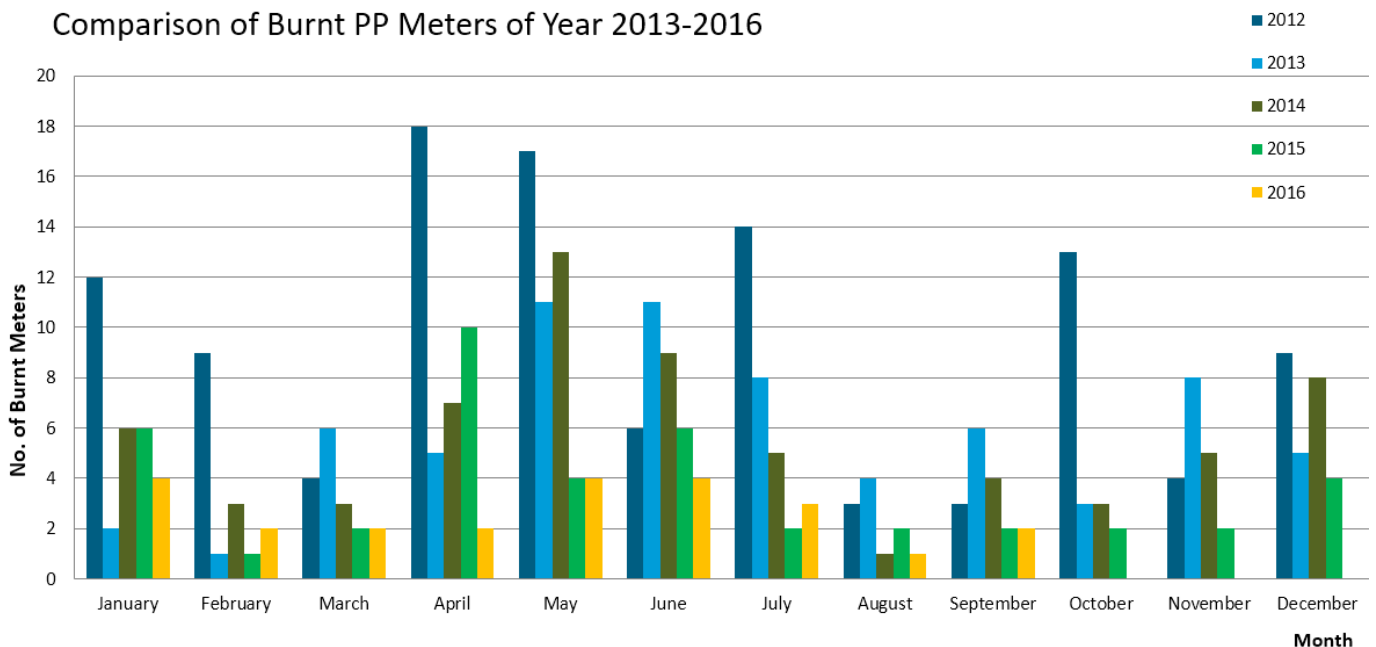

Figure 6.8: Comparison of burnt PPMs in DD3 during 2013 – 2016

Comparison of burnt distribution transformers against the transformer population of the selected sample during the period of year 2013 to 2016 is shown in Figure 6.9.

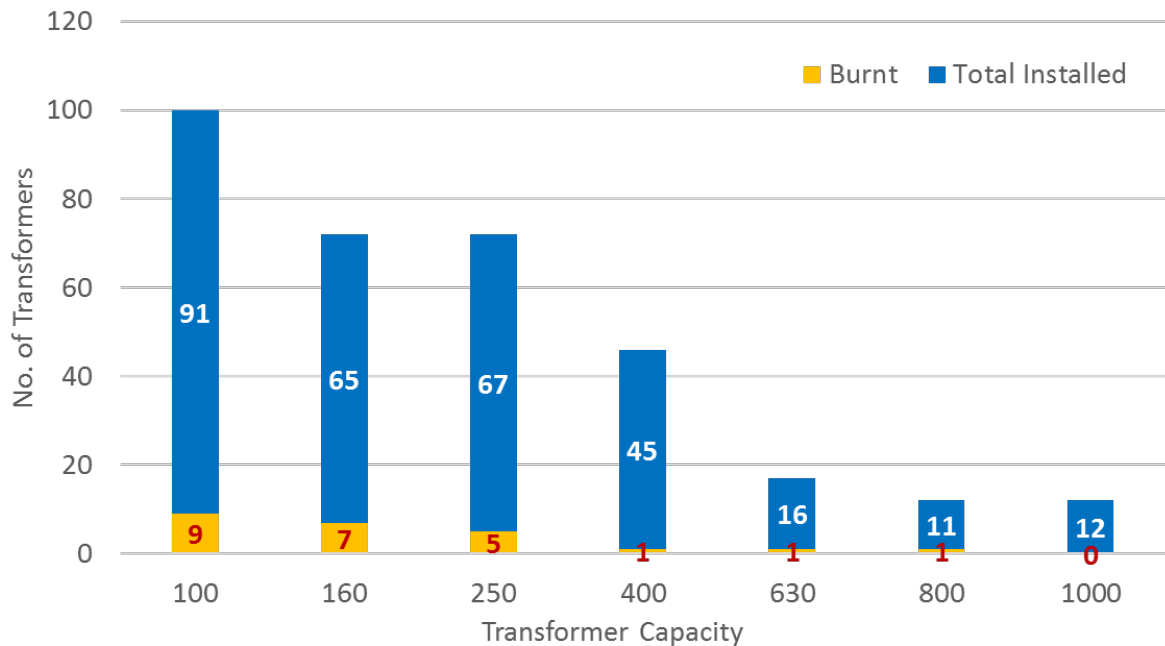

Figure 6.9: Burnt DT during 2013 – 2016 Against the Sample Selected

However, from the Figure 6.10 it is observed that the total number of transformer burnings during 2012 – 2015 does not show a clear reduction of transformer burning in the last two years after introducing LV surge protection.

Burnt Transformers in year 2012 - 2015

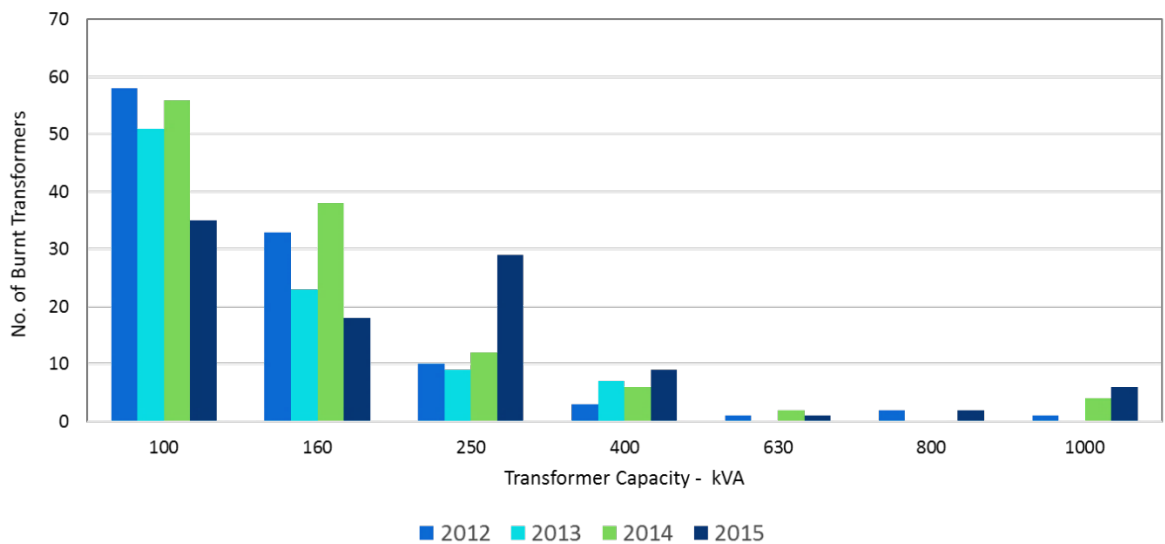

Figure 6.10: Burnt DTs in DD3 during 2012 – 2015

7 CONCLUSION AND RECOMMENDATION

The results obtained from the simulation model and the field implementation were studied. As this field implementation is still going on, continuous monitoring and analyzing should be done to obtain results with higher accuracy.

7.1 Conclusion

Following conclusions were derived from the results of the simulation model and the field implementation

- ✓ From the field implementation results obtained so far, the simulation results are proven to be correct that there is a large impact of lightning on low voltage side of the power distribution substations in CEB.
- ✓ LV surge protection should be done for power distribution substations to protect the transformer and other installations in the secondary side of the transformer. Further the protection level at PDS reflect on the consumers connected to the PDS and they will also be benefited from LV side protection system at PDS.
- ✓ Induced surges or direct strikes on the load side of the transformer cause heavy damage to the substations in areas with higher isokeraunic levels. Those substations can be protected by installing multiple SPDs with higher current ratings.
- ✓ As the cost of set of SPDs are around Rs. 6,000.00, compared to the cost of PPM which is around Rs. 45,000.00. Cost saving can be achieved by applying SPDs in LV side.
- ✓ Even though, it is not exactly verified by the field implementation results that the transformer burnings are reduced by this project, the simulation model clearly shows the impact of secondary side surges on distribution transformers. Hence, it could be concluded that by applying LV surge arresters, the level of protection of transformer could be increased so that the effective life of the transformer will be increased.

7.2 Recommendation

It is recommended to continue the field implementation to obtain more results to verify the effectiveness of the project. Ratings of the purchased LV surge arrester is not enough to protect the PDSs in critical areas with higher lightning currents and with frequent lightning strikes.

Further, it is recommended to protect LV side of the power distribution substations to ensure the protection of equipment attached and the transformer itself. Effective life of the transformer can be increased by the added protection of low voltage side SPDs.

Awareness of low voltage surge protection among technical staff of CEB should be enhanced by the means such as technical publications, trainings and workshops.

7.3 Limitations Identified

The following problems and limitations were identified from the results in previous chapter.

- Applying this solution will not work at all substations because of the unpredictable, probabilistic nature of lightning surges.
- Different practices used in different areas for substation installation, earthing, load connection, etc. cause degradation of substation protection.
- Available protection methods for outdoor LV lightning protection is limited.
- Difficulty of monitoring of all the LV side protected substations to verify if the arresters are working properly or damaged.
- Difficulty in getting approvals to implement the project as it is a new thing which is not in practice.
- Lack of knowledge in field workers about lightning protection cause substandard installations.
- Limited options available in the international market for outdoor low voltage surge protection.

8 REFERENCES

- [1] W. D. A. S. Wijayapala and H. S. C. Karunananda, “Mitigation of Lightning Surge Stresses in the High Voltage Windings of Distribution Transformers by Introducing an Electrostatic Shield”, ENGINEER - Vol. XLVIII, No. 03, pp. [1-11], 2015.
- [2] Chandima Gomes “a tutorial on the selection and installation of surge protection devices in a tt wiring system” 30th International Conference on Lightning Protection - ICLP 2010 (Cagliari, Italy - September 13th -17th, 2010).
- [3] M.A.R.M.Fernando, V.Coaray “Lightning surges at distribution transformer secondary”, International Conference on Industrial and Information Systems (ICIIS), 2010.
- [4] IEEE Guide for the application of surge-protective devices for low voltage (1000 V or less) AC power circuits, IEEE Std. C62.72™-2007.
- [5] Alexandre Piantini¹, Jorge M. Janiszewski, Thaís O. de Carvalho, Paulo F. Obase “Lightning-caused Transformer Failures in Distribution Systems” 2014 International Conference on Lightning Protection (ICLP), Shanghai, China.
- [6] Nehmdoh A. Sabiha and Matti Lehtonen “Lightning-Induced Over Voltages Transmitted Over Distribution Transformer with MV Spark-Gap Operation—Part II: mitigation Using LV Surge Arrester” IEEE transactions on power delivery, vol. 25, no. 4, October 2010.
- [7] J R Lucas and D A J Nanayakkara “Lightning protection of pole-mounted transformers and its applications in Sri Lanka” Transactions of the IEE Sri Lanka – April 2001.