

METHODS FOR IMPROVEMENT OF
ENGINEERING PROPERTIES OF PEAT
-A COMPARATIVE STUDY

Project Report Submitted in partial fulfillment of the



M. Eng. Degree Course
University of Moratuwa, Sri Lanka.
in Geotechnical Engineering

Electronic Theses & Dissertations

www.lib.mrt.ac.lk

Ms. W.G.S. Munasinghe



UNIVERSITY OF MORATUWA
THESES & DISSERTATIONS

Supervised By : Dr. S.A.S. Kulathilaka

624"01"
624.131.27

Department of Civil Engineering
University of Moratuwa
Sri Lanka

April 2001

METHODS FOR IMPROVEMENT OF ENGINEERING PROPERTIES OF PEAT -A COMPARATIVE STUDY

Project Report Submitted in partial fulfillment of the



M. Eng. Degree Course
University of Moratuwa, Sri Lanka.
in Geotechnical Engineering
Electronic Theses & Dissertations
www.lib.mrt.ac.lk

Ms. W.G.S. Munasinghe

ප්‍රකාශනය
කරුවන් විසින් විද්‍යාලය, ශ්‍රී ලංකාව
සමරුව.

Supervised By : Dr. S.A.S. Kulathilake

074345



University of Moratuwa

Department of Civil Engineering
University of Moratuwa
Sri Lanka

April 2001

74345

624 "01"

624.131.27

74345

TH



ACKNOWLEDGEMENT

Even a small research owes its existence to many more people than the one whose name appears as researcher. I am immensely grateful to this research's formulator Dr. S.A.S.Kulathilake, Department of Civil Engineering, University of Moratuwa, who contributed a great deal to this research. His guidance, support and stimulating criticisms made the research a complete success.

The support of course co-ordinator Dr.U.G.A.Puswewala is highly appreciated in memory of the scheduling of research activities. I would never get the chance of doing this research study unless the Scholarship granted by the Asian Development Bank and their consideration is very much appreciated.

I respect the management of National Building Research Organisation for their kind support by allowing me to carry out the laboratory tests. I shall also forward my gratitude to the following soil laboratory staff for their kind assistance and corporation throughout my project period.



University of Moratuwa, Sri Lanka.
Electronic Theses & Dissertations
www.lib.mrt.ac.lk

- University of Moratuwa: Mr. K.R.Pitipanarachchi, Mr. D.G.S. Withanage and Mr. D. Bandulasena
- National Building Research Organisation: Mr. Chandima Ahangama, Mr. Soysa and Mr. Ajith
- Road Development Authority, Research Laboratory, Ratmalana: Mr. Paranayapa

I would also thank to Mr. Nuwan Kodagoda – Computer Division for his support and Ms.Pradeepa Peiris for her assistance in report documentation. My sincere thanks are also forwarded to Mr. Asiri karunawardena, Ms. Prishantha Dissanayake and Ms. Rathnajothe for their keen support and my colleagues Nirmalee, Sudeera, Udeni, Thushara, Kumudini, Dishmie and all others are also acknowledged for their corporation.

Sriyani Munasinghe

ABSTRACT

Development of cost effective methods for improvement of engineering properties of peat is a need of the hour in Sri Lanka in view of the number of major infrastructure development projects that are proposed over the lands underlain by peat. In this research several different methods of improvements were tried out in Sri Lankan peat, which have a rather low organic content around 20%-40%. The improvement methods tried out were namely; pre-consolidation through preloading, mixing with cement at percentages of 5%, 10% and 15% and mixing 15% of lime. Peats at different levels of humification were used in the study.

It was shown that the preconsolidation causes a significant improvement in both the primary and secondary consolidation characteristics irrespective of the degree of humification. Improvements were achieved in both the fibrous and amorphous peat.

Even after the mixing of 15% of cement or 15% of lime significant improvements of consolidation characteristics could not be achieved in fibrous peat. But, even the mixing of 5% cement caused significant improvements in both the primary and secondary consolidation characteristics in amorphous peats. The organic contents of the two types of peat considered were similar.

Improvements of shear strength were achieved in all types of peat due to preconsolidation. Mixing with cement also caused some improvements in undrained shear strength of Peat. However, these improvements were not as high as those reported for inorganic soils.

Consolidation tests were conducted with simultaneous measurement of settlement and pore water pressure, in a new experimental setup developed. The data obtained were used to check the validity of the Terzaghi theory to model the consolidation behaviour of peat. Some experiments were conducted to derive Bjerrum curves for Peat.

CONTENTS

Acknowledgements

Abstract

Chapter	Page
1 Problematic nature of Peat and Need for Improvement of Soft Peat Layers	
1.1 Problematic Nature of Peat	1
1.2 Formation of Peat	2
1.3 Organic Content	3
1.4 Improvement of Peat	4
1.5 Outline of the Thesis	5
2 Improvement of Engineering Properties of Peat by Pre-consolidation and Deep Mixing	
2.1 Improvement of Engineering Properties of Peat by Preloading	7
2.2 Improvement of Engineering Properties of Peat by Deep Mixing Method	11
3 Selection of Peat types and sample preparation	
3.1 Types of peat in Sri Lanka	16
3.2 Basic properties of selected peat	16
3.3 Specimen preparation and the laboratory simulation of improvement	17
4 Comparison of improvements in primary consolidation characteristics	
4.1 Introduction	19
4.2 Improvement in coefficient of volume compressibility	19
4.3 Improvement in compression index and compression ratio	20
5 Comparison of improvements in secondary consolidation characteristics	
5.1 Introduction	30
5.2 Variation of C_{α} with stress level	30
5.3 Variation of C_{α} with time	31
5.4 Variation of C_{α} with overconsolidation achieved in preloading	32



University of Moratuwa, Sri Lanka.
Electronic Theses & Dissertations
www.lib.mrt.ac.lk

6	Comparison of improvements in shear strength characteristics	
6.1	Improvement of undrained shear strength due to cement and lime mixing	40
6.2	Improvement of undrained shear strength due to preloading	41
7	Modeling the consolidation behaviour of Improved and untreated peat	
7.1	Background	45
7.2	Development of a laboratory setup for simultaneously measurement of pore water pressure and settlement	
7.3	Testing procedures and test results	47
7.4	Back analysis of the test results using Terzaghi Model	53
7.4.1	Fundamentals of Terzaghi Model	55
7.4.2	Analysis of Test data	55
7.5	Application of Bjerrum model concepts for peaty clay	
7.5.1	Bjerrum Model and Aging Curves	56
7.5.2	Experimental procedure and results	58
8	Conclusions	67
9	References	68
	Appendix	

CHAPTER 1

Problematic nature of Peat and Need for Improvement

1.1 Problematic Nature of Peat

With the development taking place in the country, there is a scarcity of lands with good sub soil condition in an around Colombo and other major cities. Therefore, Civil Engineers are compelled to build new structures and infrastructure facilities in areas where existing ground conditions are not very favourable. Construction on soft ground leads to stability problems during the construction and long-term settlements during the service.

In the city of Colombo and suburbs number of new projects are proposed where there are soft organic clay/peat layers of thickness as high as 10m. These soils possess very poor engineering qualities of high compressibility and very low shear strength. Peats consist of remains of dead vegetation and animal matters in various stages of decomposition and they usually have very high natural water contents (of the order of 500% on some cases), very high void ratios (in the order 8 – 10 in some cases) and low specific gravities (as low as 1.5). Because of these properties, they show high compressibility and very low shear strength causing very high settlement and shear failures in constructions associated with them. Furthermore, peats have considerably high secondary compressions that continue for a long time. Another notable feature is that the properties could change rapidly within a very short distances even in the same site, due to different levels of decomposition.

Peats are often seen in low lying areas subjected to flooding and often these sites are required to be filled up to a given level prior to any construction. Due to the loads imposed by the fill and the structures, the soft peaty soil will be subjected to large settlements. In some situations, heavy loads from the super structure can be transferred to an underlying harder stratum through piled foundations. However, it is not the most economical form of foundation when the roads and service lines are to be constructed. Even for the lightly loaded buildings, the provision of piled foundations may not be economically viable. In such situation, it would be appropriate either to replace the peat with a stronger material or to improve the engineering properties of peat.

With many projects proposed over the lands underlain with peat/organic clays in Sri Lanka in the next few years it is a need of the hour to develop cost effective alternate methods to improve the relevant engineering properties of peats.

1.2 Formation of Peat

Peat consists of partially decomposed and disintegrated plant remains. The conditions under which peat will begin to accumulate are determined primarily by climate and topography. Peats accumulate under incomplete aeration and high water content in poorly drained areas where there is an excess of rainfall.

Humification is the process by which the plant organic matter is broken down by soil micro flora, bacteria and fungi. Terms such as decay, decomposition and breakdown are also used for this process. These organisms require oxygen. The end products of humification are thus carbon dioxide and water. Immersion in water catastrophically reduces the oxygen supply thereby reduce the population of aerobic micro flora and encourage the activities of anaerobic species with different and less rapid metabolic activity. Therefore the reduction in total activity causes the accumulation of partially decayed vegetable matter as peat. Hobbs (1986).

Apart from the oxygen supply the process of decaying is also influenced by temperature, acidity and the availability of nitrogen. Generally, when the temperature and PH value is higher the decomposition is faster and the accumulation of peat would be slower. A temperature in the range of 35 to 40 c° is ideal for decomposition and the peats will not accumulate. Hobbs (1987) found that peat does not accumulate unless the PH values are less than 5.5. In Sri Lankan peats the PH values found were in the range of 2 to 3 and hence provides an ideal condition for accumulation.

As the humification process continues the original fibrous structure of the peat is lost and the peat gets an amorphous and granular appearance. The physical and engineering properties of peat are closely related to the average state of humification. Von Post (1922) proposed a simple field test for assessing the degree of humification on a scale of 1 to 10.

1.3 Organic Content

The purity of peat is an important property and is customarily determined by measuring the organic content. The usual method for determining the organic content for peat is to burn off the organic matter after drying the specimen at 65c°. The furnace temperatures of the order of 450 – 550c° are used in the burning.

Peat that is completely free of extraneous mineral matter may have ash content as low as 2%, and thus an organic content of 98%. At the other extreme a lake mud or peaty clay may contain less than 10% organic matter. In Sri Lanka peat usually the organic content varies between 20% and 40%. However, as reported by Hobbs (1987), in the Russian geotechnical practice a Peat is classified as a soil containing more than 50% of organic matter. The American practice use the term only for a soil containing more than 75% of organic matter. On that basis the peats that we encounter in Sri Lanka can be classified as peaty clays.

1.4 Improvement of Peat

Different methods are available for the improvement of compressibility / stiffness characteristics and shear strength of soft clays and peats. The two approaches in the improvements process can be classified as densification techniques and solidification techniques. Preloading, vacuum preconsolidation and dynamic compaction, are some of the most widely used densification techniques. Addition of a cementitious material and mixing over the full depth of layer in order to solidify the soil can be classified as a solidification technique.



University of Moratuwa, Sri Lanka.
Electronic Theses & Dissertations
www.lib.mrt.ac.lk

Most commonly used densification technique is the reduction of void ratio by preconsolidation of the soft clay through preloading. A load equivalent to or exceeding the expected design load of structure is applied on the soil layer before the construction. This is usually done by the placement of an earth fill. Applied load is left there until the required consolidation is achieved. During the preloading period, clay will consolidate causing a reduction in void ratio and will experience an increase of shear strength. To be most effective, the amount of preload removed at the end of the preloading period should be more than the expected design load. Preloading is one of the most inexpensive methods for densification and can be implemented without the use of special machinery. The vertical drains may be used to accelerate the process of consolidation. If the soft clays of very low shear strength, the preload may have to be applied in several stages and the project may extend over a longer period. Another possible option in such instances is to make use of berms.

Vacuum dewatering, which is also known as vacuum consolidation, is another densification technique. Initially a layer of free draining material is placed on top of the clay and covered with an impermeable membrane. Thereafter a vacuum is applied to the soil mass reducing the atmospheric pressure that is normally there. Usually vertical drains are also used in an appropriate grid. While the total stress remains unchanged, a vacuum is created on top of the soil

layer and in the vertical drains due to the vacuum pump. The pore water pressure gradient thus created will cause the water to move towards the vertical drains and finally drain out of the soil. This will reduce the pore water pressure in the soft soil and increase its effective stress. The void ratio is also decreased due to the expulsion of water. As there is no external load applied, this will not lead to shear failures in the soil. As such, this is an ideal solution in the case of very soft clayey soils.

Dynamic compaction can also be used to densify thick peat layers. Deep compaction of the soft soil is achieved by applying impact energy into the subsoil. This method reduces the total and differential settlements and increases the shear strength. Improvement of secondary consolidation characteristics were also achieved by this process.

Deep mixing of soft soil with the addition of a cementitious material can be classified as a solidification technique and it has two major aspects of 'insitu stabilisation' and 'insitu fixation'. This soil improvement technique mixes the soil with cementitious material (such as cement, lime, fly ash or even biological reagents) in the form of slurry or powder to improve the engineering properties of the soft soil. Specially designed machines with several shafts equipped with mixing blades and stabilizer injection nozzles are used to construct insitu treated soil columns in various patterns and configurations.

It is preferable to use cement compared to lime due to reasons such as; the lower cost when compared to lime, and the difficulty of storing lime in a hot and humid climate. A practice of using cement and lime together has also started recently.

This method is successfully applied for soft clays by Japanese and Swedish Geotechnical Engineers. Addition of lime or cement has shown a very effective and reliable way of achieving a rapid improvement of engineering properties of the soft inorganic clays. But not much records are available about the application in peaty soils except for some case histories from Finland. (Huttunen et al 1996).

1.5 Outline of the Thesis

In this research project, the processes of preloading and deep mixing with cement and lime were simulated under the laboratory conditions. Different proportions of cement and lime were used in the mixing process. The shear strength characteristics and primary and secondary consolidation

characteristics of both the treated and untreated peats were determined in the laboratory and comparisons were made to assess the levels of improvements that can be achieved. Consolidation characteristics of peat in the loading increments and reloading increments were compared to assess the improvements achieved in the preloading. Improvement of shear strength due to consolidation was also studied. Peats at different levels of humification were used in the study.

Chapter 2 of the thesis presents a detailed description on the current state of the improvement methods of preloading and deep mixing with cementitious materials. The use of stone columns in soft clayey soil was also briefly described in the chapter.

Chapter 3 justifies the selection of different peat/soft clay types for the research and describes the process of sample preparation and the design of the test procedure to simulate the preloading and deep mixing under the laboratory conditions.

Chapter 4 compares the improvements achieved in the primary consolidation characteristics by the process of deep mixing and preloading.

Chapter 5 compares the improvements achieved in the secondary consolidation characteristics by the process of deep mixing and preloading. Improvements in shear strength achieved through these methods were compared in chapter 6.

Chapter 7 discuss the need to find a suitable model to represent the consolidation behaviour of the peat. Attempts made to apply the Terzaghi model and Bjerrum model to represent the consolidation behaviour of the peat, are outlined in the chapter. Development of an experimental setup to measure the pore water pressure and settlements simultaneously is also presented in chapter 7. The data obtained through this setup were used in the attempt to model the behaviour of peat through the Terzaghi Theory.

The experimental process and the results thus obtained in the attempt to obtain Bjerrum's curves for the Madiwela Peat is also presented in the Chapter 7.

Chapter 8 concludes the findings of this research, and suggests areas for further research.

CHAPTER 2

Improvement of Engineering Properties of Peat by Pre-consolidation and Deep Mixing

Number of different techniques are used to improve the engineering properties of soft peaty clays. There are densification techniques through consolidation of the peaty clay by application of a surcharge. Consolidation has also been achieved by the application of a vacuum, with or without the use of a surcharge. Dynamic compaction is another technique that had been tried out with peaty clays with very encouraging results (Lo et al 1990). Deep mixing with cement or lime is widely tried out with soft inorganic clays. There are limited records of the use of the technique with peat (Huttunen et al 1996).

As this research project was conducted with the objective of comparing the effectiveness of the methods of preloading and the deep mixing for the improvement of peaty clays, a detail discussion of the two techniques is done in this chapter.

2.1 Improvement of Engineering Properties of Peat by Preloading

In the preloading technique the sub soil is preconsolidated usually by applying a load that is equal to or greater than the intended structural load. Normally, preloading is supplied with an earth fill of estimated thickness. Once the required consolidation is achieved the preload fill shall be removed prior to the construction of the final structure. The preloading period necessary could be estimated using the laboratory determined coefficient of consolidation. But the removal of preload shall be done only after confirmation of the consolidation through the field monitoring of the settlements and pore water pressures.

After removal of the preload, the soil behaves as an over consolidated soil and the settlement due to the construction of the structure would be much smaller. The process can be illustrated using the e vs $\log \sigma$ plot in Figure 1 and the corresponding sketches in Figure 2.

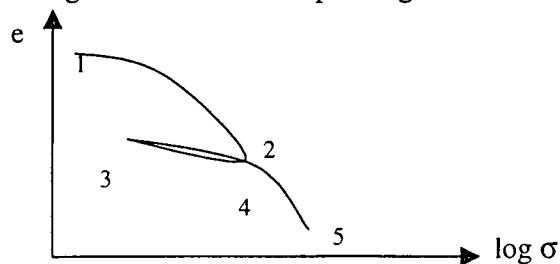
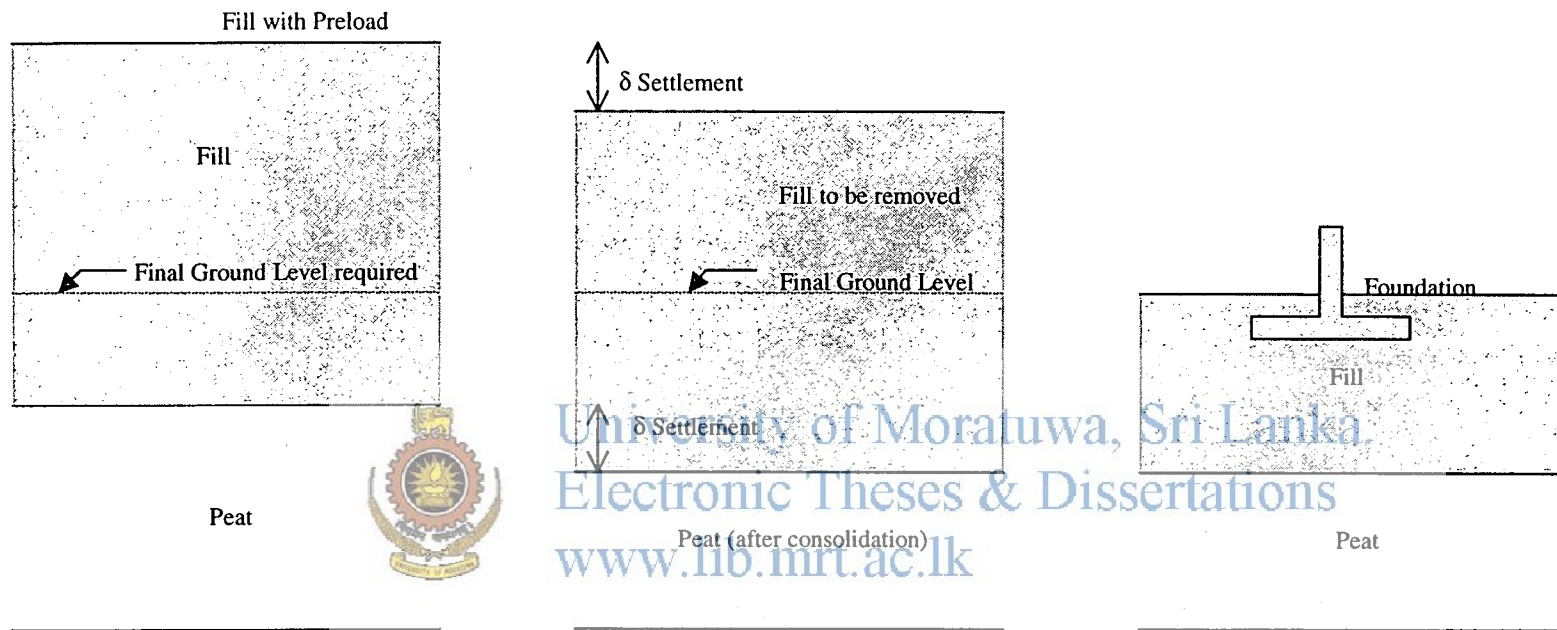

Figure 1: e vs $\log \sigma$ curve



(a)- Placement of Preload

(b)- After Consolidation

(c)

Figure 2 – Graphical Illustration of Preloading Process

Normally peats are associated with low-lying areas and to prevent possible flooding, it would be necessary to have an increase in ground level. Once the fill load is applied, soft soil layer will be subjected to consolidation and the fill layer will settle with the soft soil (Figure 2(b)). The state of the soft soil will move from point 1 to point 2 in the e vs $\log \sigma$ curve (Figure 1). In order to prevent the settlement of the fill itself, fill material should be placed in layers and well compacted. If the field observations show that the required consolidation is achieved, the preload could be removed while trying to maintain the required ground elevation (Figure 2(C)). The state of the soil will move from point 2 to point 3 (Figure 1) due to the removal of preloading. Now the construction can be carried out and the load of the structure will cause the soil to move along the path 3-4-5 (Figure 1). The line 3-4 is with flatter gradient almost in line with 2-3 and after passing the point 4 settlements would occur along a much steeper line 4-5. (Figure 1). Therefore, sufficient care should be taken to ensure that stresses due to the structure would not take the state of the soil beyond point 4.

One of the major concerns of the preloading technique is the long time taken for the process. The consolidation process may be accelerated by using an additional surcharge load or by the use of vertical drains such as, sand drains, prefabricated plastic drains or fiber drains (Fibre drain) made of natural jute and coir fibres.

Although the preloading is a cost effective method, the required total fill may not be applied on the soft peaty soil in one increment without causing shear failures. In such instances techniques such as staged loading, the use of berms and use of stone columns may have to be used. The appropriate process shall be designed having considered the strength of the peat, the thickness of the peat layer and the total fill thickness required.

In the staged loading process the peat / soft clay is allowed to consolidate for some time under a safe thickness of fill placed. Once the peat has achieved sufficient strength through the consolidation, further fill can be placed at a second stage (Figure 3(a)). Further stages of filling may be required depending on the total fill thickness needed and the strength and the thickness of the peat layer. The use of a berm at toe (Figure 3(b)) can improve the stability of the fill. Berms are often used together with the staged loading. A wider fill can be placed at the first stage and once the peat has consolidated second stage can be placed, leaving a berm of necessary width.

When the fill thickness required is high for the case of a very soft peat layer of larger thickness, staged loading process or the use of berms may not provide adequate stability. Additional strengthening of the peat by the use of stone columns or sand compaction piles would be required in such instances. In the composite ground made, a major part of the fill load would be carried by the stone columns. As such, the settlements in the soft peat will be reduced. Any potential failure surface will have to shear through the stone columns and the stability against potential failures is also greatly enhanced. The required spacing and size of the stone columns has to be designed for a given situation depending on the fill thickness required and the state of the peat layer.

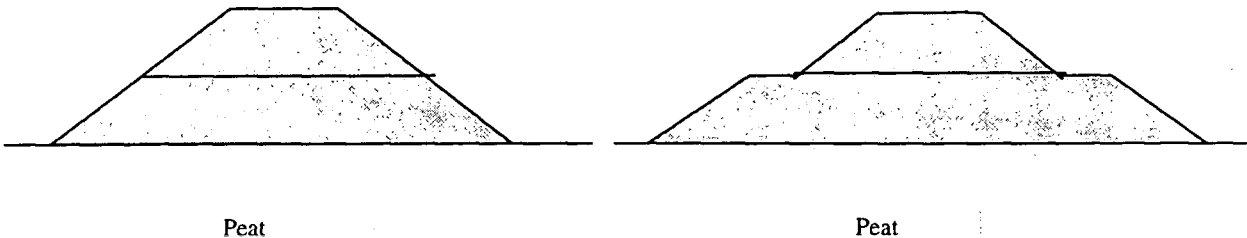

University of Moratuwa, Sri Lanka.
 Electronic Theses & Dissertations
www.lib.mrt.ac.lk

Figure 3 (a) : Staged Loading

Figure 3 (b) : Loading with Berms

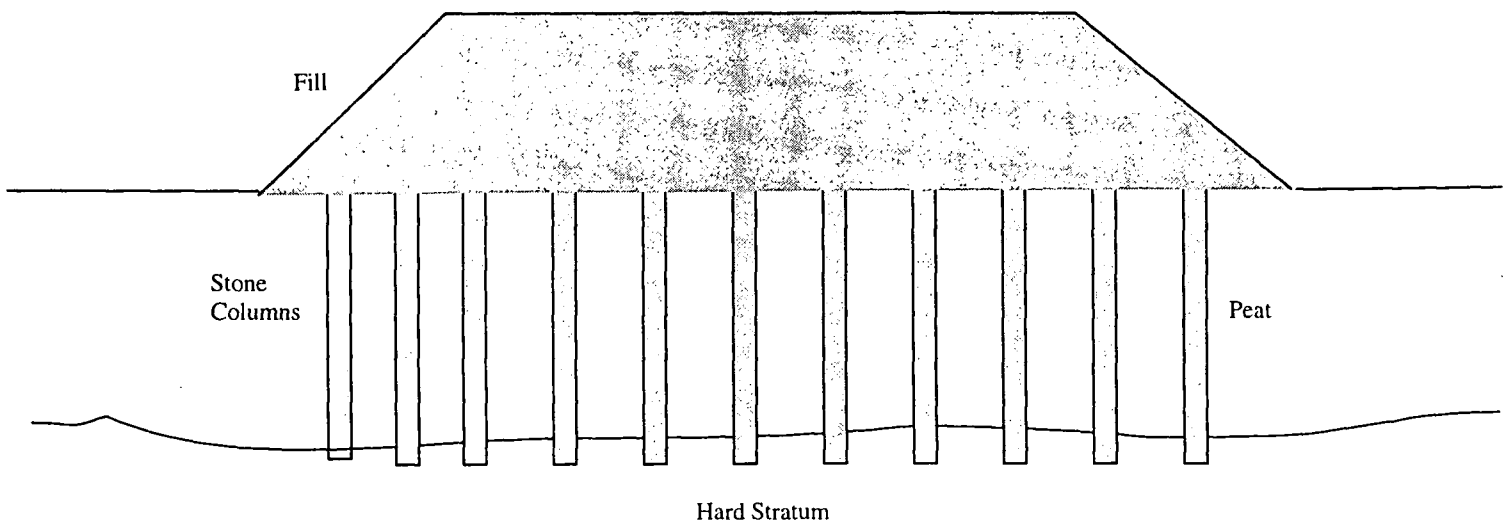

Figure 3(c): Use of Stone Columns

In the construction of stone columns, the soft soil shall be removed by making a borehole and the volume be replaced by good quality granular material brought from elsewhere. A unit cell (plan) in the peat / stone column system is shown in Figure 4 (a). The area of (cross section) peat is denoted by A_s and the area of stone column is denoted by A_c . The replacement ratio is defined as; $a_s = A_s / (A_s + A_c)$ (Figure 4). Often, the stone column technique will require replacement ratios of the order of 20%, 30%, (Abostu and Suematsu 1985). Once a load is applied on the composite ground formed, stone columns will take a greater share as indicated by the stress concentration in Figure 4 (b).

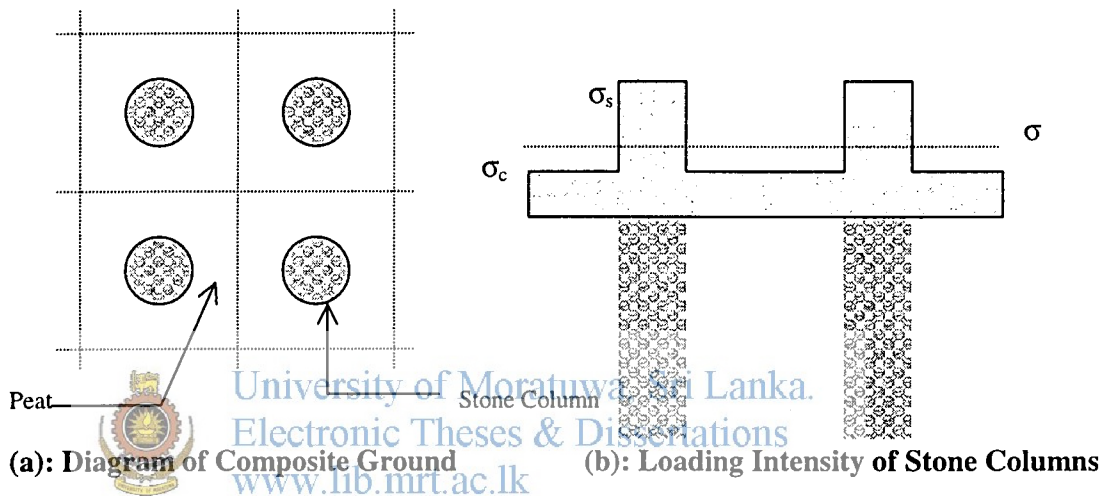

Figure 4 - Stone Column Technique

2.2 Improvement of Engineering Properties of Peat by Deep Mixing Method

Deep mixing method is a solidification technique that mixes existing soil with cementitious materials using mixing shafts consisting of auger cutting heads, continuous auger flights and mixing paddles. Number of mixing shafts connected to the equipment depends on the purpose of the project. Cementitious materials are generally delivered in a grout or slurry form from parts in the cutting heads located in the lower ends of the multiple shafts. This method was developed in Japan in 1960's and widely used in 1970's for improvement of soft clayey soils. The deep lime mixing (DLM) was brought into practice throughout Japan and South East Asia in 1974. In 1975, the cement deep mixing (CDM) - the "wet method" of deep mixing using cement slurry was introduced. Independent developments have taken place in Sweden from 1970. Lime was used as a stabilizer in Sweden and cement was more commonly used in Japan. In recent years a mixture of cement and lime has had increased attention in both countries.

In inorganic soils the soil- cement or soil-lime composite have produced extremely high strengths and low compressibilities in comparison with the densification techniques. In some situations as

in congested urban areas, the construction period could be the dominant factor and preloading technique may not be acceptable.

This method had been particularly useful in instances where deep excavations were to be done on soft clays. By improving the soft soil by the application of a solidifying agent, the strength and the stiffness of the soft clay can be significantly improved within a short time in the order of 4 weeks.

This method makes use of the existing soil and no spoil is created. Insitu soil itself is mixed with the cementitious material. As such, it is not necessary to bring high quality granular fill from outside. Often the percentage of cementitious material to be added would be in the order of 5% to 15% (by weight), which is much lower than the replacement percentage usually needed in the case of stone columns. The other advantage of using deep mixing method is the creation of lower noise and vibration during construction than in the conventional methods of granular stone columns or sand compaction piles.

The deep mixing machine used must be capable of supplying the stabilizer (cement or lime) uniformly into the soil and achieving sufficient mixing of the soil and the soft soil. Specially designed machines with several shafts equipped with mixing blades and stabilizer injection nozzles are used to construct insitu treated soil columns in various patterns and configurations. Mainly, there are two types of mixing methods as Mechanical method and Pressurized method. In mechanical method (Figure 5(a)), additives are supplied in slurry form or dry additives are supplied with air. In pressurized method (Figure 5(b)), mixing is carried out by pressurized grout, by pressurized grout and compressed air or by pressurized grout, compressed air and pressurized water. Now there are machines where both systems of mechanical mixing and pressurizing are combined to produce much larger diameter treated columns more efficiently.

The successive stages of the process in the mechanical method is illustrated in Figure 6. A cross section through several mixed columns is presented in Figure 7. In practice deep mixing is installed in different patterns such as in the form of blocks, walls, grid and columns as shown in the Figure 8. One unit in either of the above geometries may consist of several overlapping columns, depending on the number of shafts and the configuration of the deep mixing machine.

There are numbers of case histories of the use of deep mixing method. Huttunen et al (1996) reported the application of the deep mixing technique to stabilize peats in Finland.

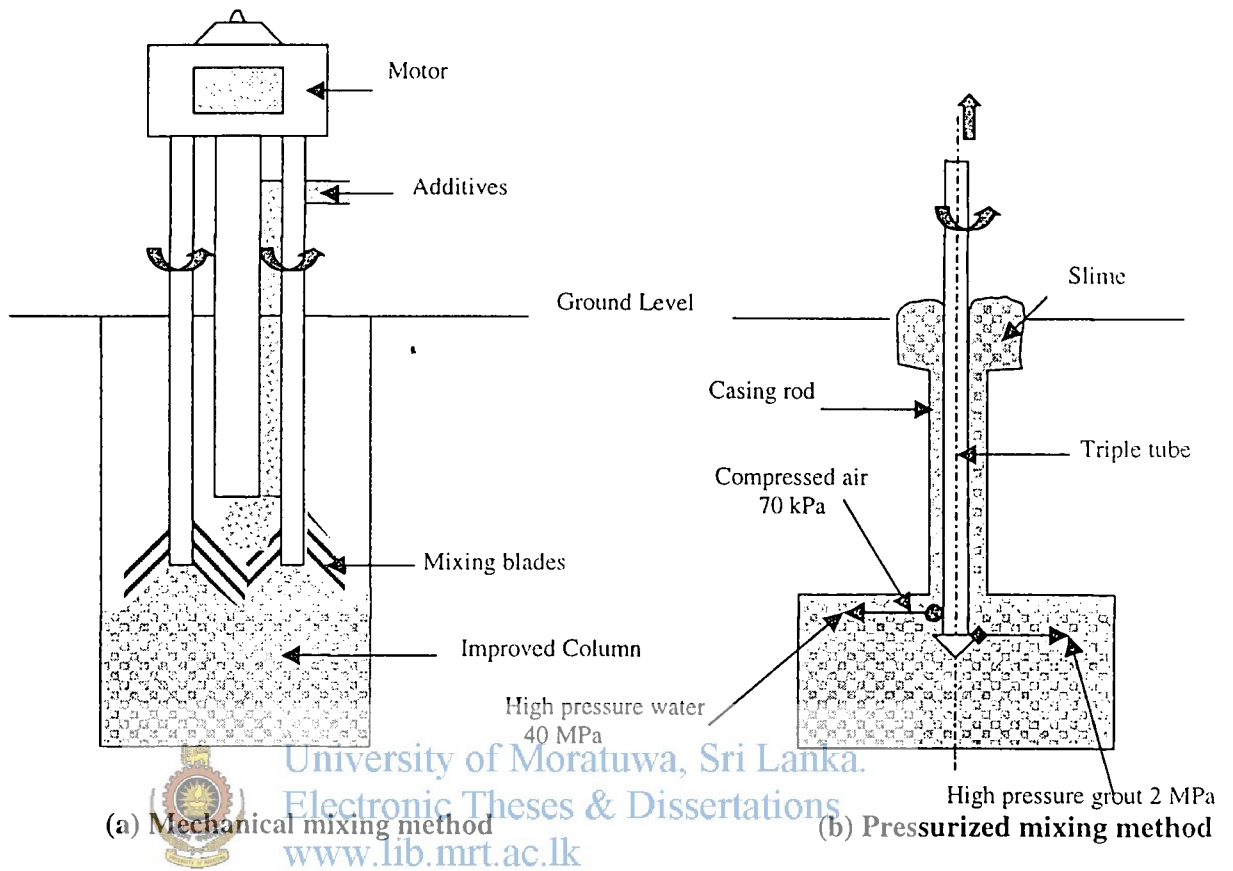

Figure 5 - (after Probha (1998))

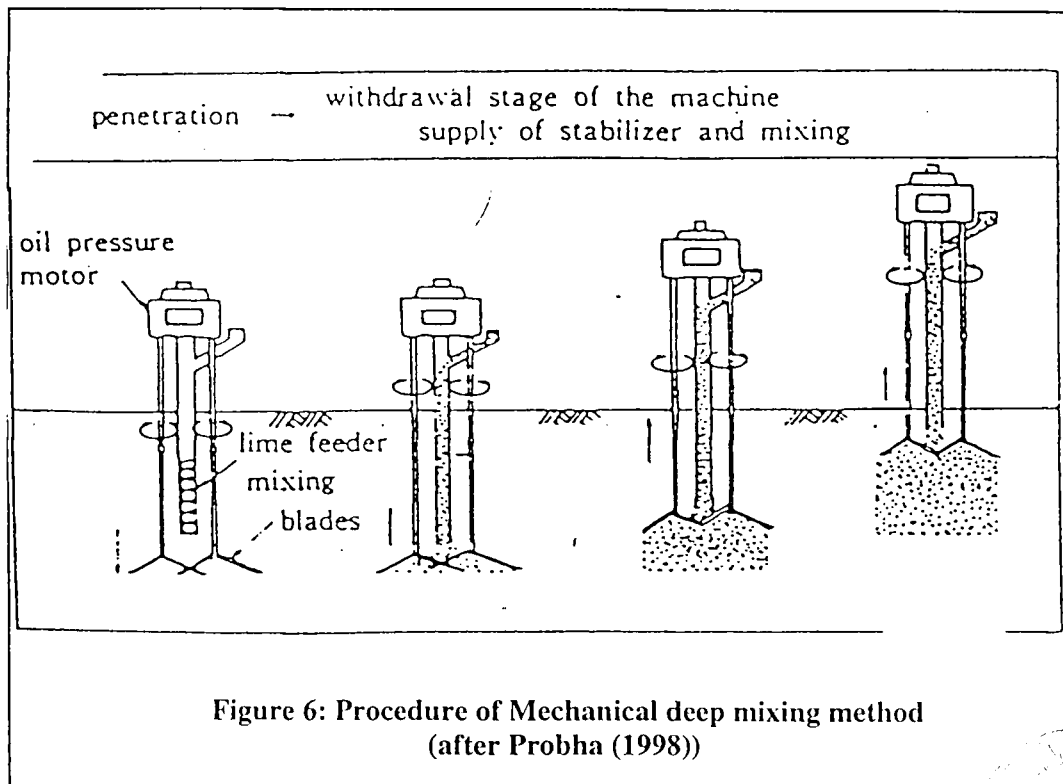
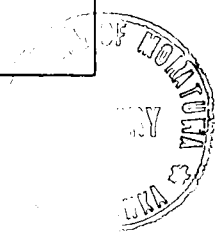
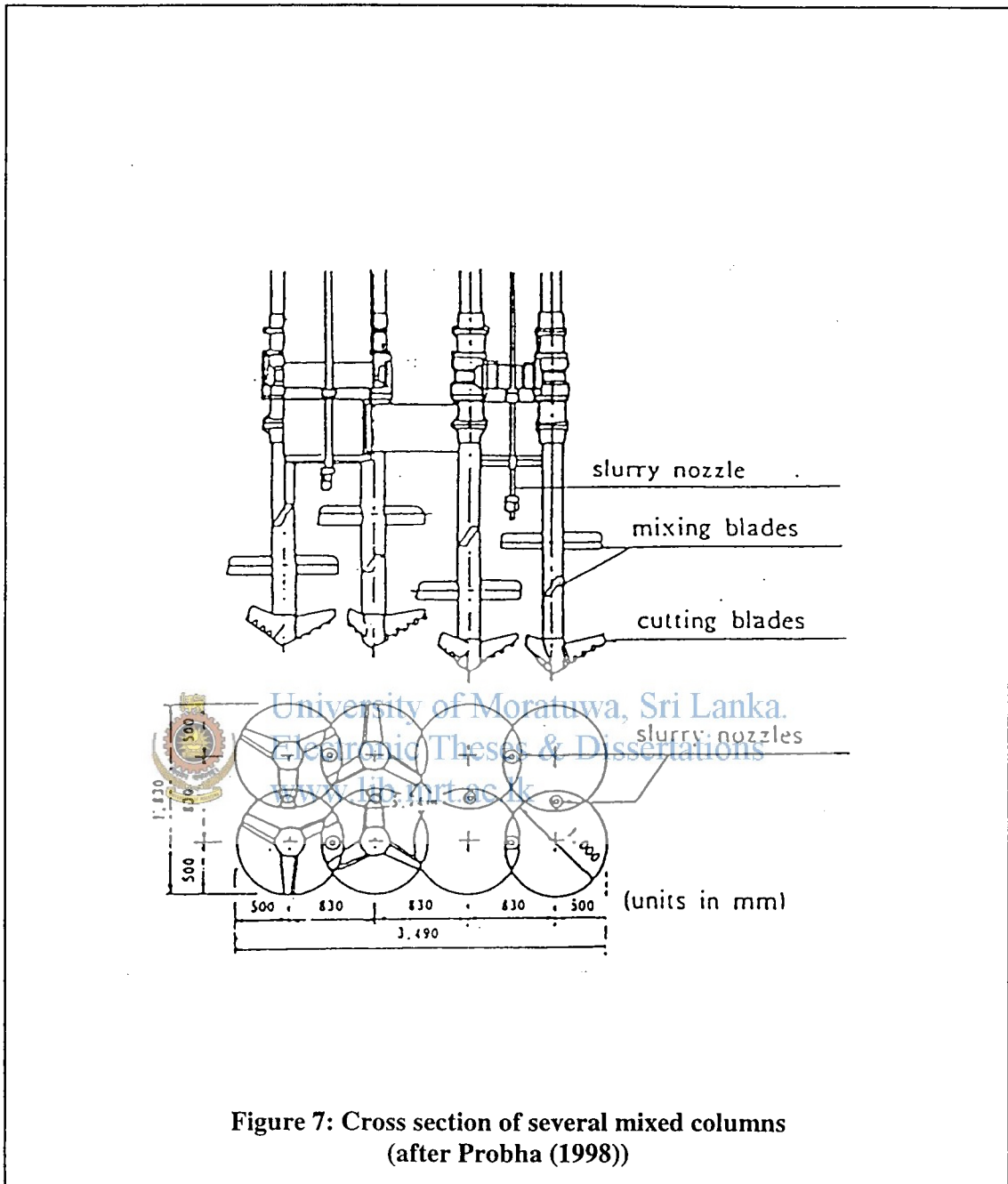

Figure 6: Procedure of Mechanical deep mixing method (after Probha (1998))





It is important to note that the strength achieved by deep mixing were very high in the case of inorganic soils. Deep mixing technology has been used very successfully for construction of marine and water front structures, for excavation to prevent the base heave, to prevent landslides, as the foundation of various structures and as a measure against seepage by applying a cut-off wall for dams, dykes and river banks.



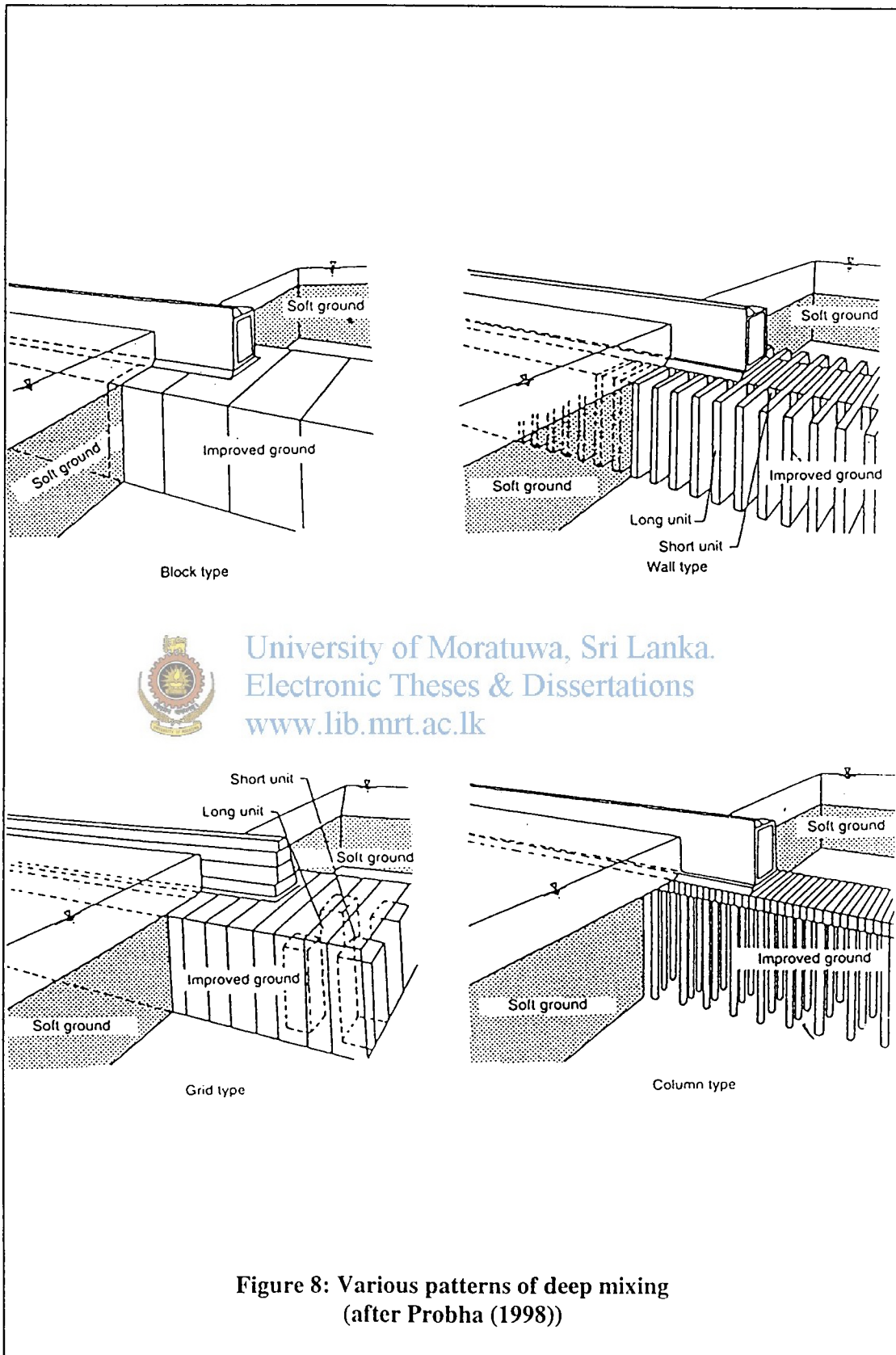

CHAPTER 3

Selection of Peat types and sample preparation

3.1 Types of peat in Sri Lanka

Several types of peat at different levels of humification were selected for this research project. The degree of improvement achievable could depend on the degree of humification and the initial water content. Hence attempts were made to obtain peats where the said properties are different.

Peats used are named here after the location from where they were obtained. However, it may not represent all the peats available in these locations as the degree of humification can be quite variable even within a site.

3.2 Basic properties of selected peat

The basic properties of the peat and their level of humification (based on visual observations) is reported in Table 1. The basic properties of Wattala Peat were nearly the same order as Madiwela peat except for the degree of humification. The moisture contents were around 250%-400%, Organic content was in the range of 20%-40%, specific gravity was in the range 1.8-2.23. The initial void ratio was very high in both Madiwela peat and Wattala peat (Table 1). Peliyagoda peat was of much lower initial water content and a lower void ratio. The PH values for the peats were less than 3.0. Tests were also conducted on an organic silt obtained from Madiwela for the purpose of comparison.

Place	Type	Natural Moisture Content	Organic Content	PH Value	Specific Gravity	Initial Void Ratio	Dry Unit wt (kg/m ³)
Wattala	Amorphous Granular Peat	387.00	29.00	2.60	2.23	8.63	220.13
Madiwela	Fibrous Peat	297.00	34.80	2.99	1.87	5.55	231.41
Peliyagoda	Amorphous Granular Peat	98.05	24.00	2.85	2.18	2.14	
Madiwela	Organic Silt	137.80	-	-	2.3	3.17	242.07

Table 1. Basic Properties of Differing types of Peat used



3.3 Specimen preparations and the laboratory simulation of improvement

In order to simulate the preloading process; loading, unloading and reloading increments were applied in the Oedometer. Loading increments represents the untreated peat and the reloading increments represented the Preloaded Peat. The improvement achieved by Preloading is evaluated by comparing the parameters derived in the loading and reloading increments at the similar stress levels.

To simulate the site condition in deep mixing method, soil is remoulded in the laboratory by an electrical hand mixer (Figure 9). In order to compare the effect of addition of cement / lime, samples were remoulded by mixing over the same time period and at the same rotating speed. Effectiveness of the method, for fibrous and amorphous peat was studied by subjecting different types of peat for this treatment. With each type of peat, specimen were made by remoulding with no cement and by remoulding with the addition of 5% cement, 10% cement, 15% cement and 15% lime. In addition, an undisturbed sample of peat was also taken. After preparing samples with the hand mixer they were left to harden in buckets for a period of four weeks under water (Figure 10).

Considering the presence of significant secondary consolidation effects in peat, consolidation tests were conducted with 2 week long load increments instead of the conventional 24-hour long increments.

Unconsolidated Undrained Triaxial tests were conducted to evaluate the improvement of shear strength when Peat is mixed with cement or lime. The effect of Preconsolidation on shear strength was evaluated by conducting Consolidated Undrained Triaxial tests on undisturbed peat specimen. The increase of undrained strength (ΔC_u) due to the increase of consolidation pressure ($\Delta \sigma_3$) was determined. The ratio $\Delta C_u / \Delta \sigma_3$ was obtained through these results.



Figure 9: Mixing peat with Cement / Lime using a hand mixer



University of Moratuwa, Sri Lanka.
Electronic Theses & Dissertations
www.lib.mrt.ac.lk



Figure 10: Preparation of samples

CHAPTER 4

Comparison of improvements of peat in primary consolidation characteristics

4.1 Introduction

Effectiveness of pre-consolidation and deep mixing methods in improving the primary consolidation characteristics were studied by comparing the parameters; coefficient of volume compressibility - m_v , compression index - C_c , recompression Index - C_r , compression ratio $C_c/(1+e_0)$ and recompression ratio $C_r/(1+e_0)$.

4.2 Improvements in the Coefficient of Volume Compressibility

The effect of preloading and deep mixing with cement and lime on the coefficient of volume compressibility m_v is illustrated in Figure 11 and 12 for Madiwela and Wattala Peat respectively. Both peats possessed similar organic contents and void ratios but the degree of humification is much higher in Wattala Peat. Madiwela peat was a fibrous peat and Wattala peat was of amorphous granular nature. The curves in two Figures present the variation of m_v with stress level for different percentages of cement / lime and reloaded peat. Note that the m_v value is also plotted on a log scale.

Considering the Figure 12, it is evident that due to the mixing of 5% cement by weight. Wattala amorphous peat experienced a significant reduction of the coefficient of volume compressibility. This was of the same order as the reduction achieved by reloading. With the fibrous Madiwela peat, although the preloading has caused a reduction in the coefficient of volume compressibility, the mixing of cement to the percentages of 5%, 10% and 15% or lime to the value of 15% has not caused much improvement as illustrated by Figure 11.

In another series of tests done with Peliyagoda peat – an amorphous granular peat with lower initial water content, the addition of 15% of lime has caused a significant improvement of coefficient of volume compressibility (Figure 13) (Priyankara et al 2000). The Figure indicated that the improvements achieved in Peliyagoda peat by lime mixing were of the same order as that achieved by preloading. In an organic silt obtained from Madiwela mixing of 5% cement caused a significant reduction in the coefficient of volume compressibility as



depicted in Figure 14. The improvements achieved due to the preloading were higher than in the case of 5% cement mixing.

The plots of m_v vs stress level done for peat only and different percentages mixing of cement and lime in Figure 11, Figure 12, Figure 13 and Figure 14 showed a gradual reduction of m_v with the increase of the stress level. This reduction of compressibility with the stress level is a common feature for all clays during consolidation.

However, the plots of the coefficient of volume compressibility vs stress level for the reloading increments of; peat only, peat with 5% cement, peat with 10% cement, peat with 15% cement and peat with 15% lime done in Figure 15, showed that the coefficient of volume compressibility increased gradually with the stress level. The plots done for the reloading increments in Wattala peat (Figure 16), Madiwela peat (Figure 17) and Madiwela organic silt (Figure 18) showed a similar behaviour. This behaviour can be explained in the following manner. Peats in the reloading increment are in an over consolidated state. As the stress level increases the over consolidation ratio decreases. At the stress level of 20 kN/m² in reloading, over consolidation ratio is four and at the stress level of 80 kN/m², the over consolidation ratio is one. As the over consolidation ratio decreases the coefficient of volume compressibility should increase. If the samples had been loaded to 160 kN/m² the m_v value would have increased further and would be in line with the extended curve for the loading increments.

It can be seen from Figure 15, 16, 17 and 18, that the coefficient of volume compressibility for reloading increments of peat mixed with cement or lime is very much smaller than that for the reloading increment with peat alone. This is quite visible even in Madiwela peat. This is an indication that the combined use of deep mixing and preloading will make the peat highly incompressible. However, the combined use of both techniques may not be economically viable.

4.3 Improvements in Compression Index and Compression Ratio

In addition to the coefficient of compressibility the compression index C_c , re-compression index C_r , compression ratio $C_c / (1+e_0)$ and recompression ratio $C_r / (1+e_0)$ can be used as independent parameters to assess the improvements achieved in primary consolidation

characteristics. These parameters can be evaluated from e vs $\log \sigma$ curve, which has loading, unloading and reloading increments. Figures 19-22 illustrate the e vs $\log \sigma$ curve for Madiwela peat, Wattala peat, Peliyagoda peat and Madiwela organic silt with different percentages of cement or lime. For the purpose of comparison some graphs are plotted together. The graphs corresponding to natural peat and 5% cement mixed peat for Wattala peat is presented in Figure 23 and the graphs corresponding to natural Madiwela peat and 15% lime mixed Madiwela Peat are presented in Figure 24.

It is evident from these comparison plots that with both Wattala and Madiwela peat (without any mixing) re-compression index C_r is much smaller than the compression index C_c . The ratio of C_r / C_c is 0.05 for Wattala peat, 0.09 for Madiwela peat. The ratio C_r / C_c has the values of 0.128 for Madiwela organic silt and 0.07 for Peliyagoda peat. Thus it is clear that the preloading can cause a significant improvement in primary consolidation characteristics in both types of peat (fibrous and amorphous) and in organic silt.

It can be seen that the gradient of loading curve for 15% lime mixed Madiwela peat is quite similar to the gradient of Madiwela peat without any lime mixing (Figure 24). However, with the amorphous type Wattala peat, the gradient of the loading curve for 5% cement mixed peat is much smaller than the gradient of the loading curve for Wattala peat without any mixing (Figure 23).

Table 2 presents the $C_c / (1+e_o)$ and $C_r / (1+e_o)$ values for improved and non-improved peat of Wattala, Madiwela and Peliyagoda and organic silt of Madiwela. It is evident from this also that the different percentage of cement mixing and lime mixing has not caused much of a reduction in the $C_c / (1+e_o)$ in the Madiwela peat. The comparison of values corresponding to "Non improved" and "Reloaded" clearly indicates the improvements achieved with preloading. However the, addition of 5% of cement has caused a Significant improvements in Wattala peat. Significant improvements were seen in Peliyagoda peat also where 15% lime mixing was done.

Peat Type	Method of improvement	Curing Time Period (wks)	$C_c/(1+e_0)$ or $C_r/(1+e_0)$
Amorphous Peat - Wattala	Non Improved	-	0.3644
	Reloaded	-	0.0527
	5% cement mixed	2	0.0365
Fibrous Peat - Madiwela	Non Improved	-	0.2516
	Reloaded	-	0.0962
	5% cement mixed	4	0.2625
	10% cement mixed	4	0.3717
	15% cement mixed	4	0.1831
	15% lime mixed	4	0.3979
Amorphous Peat - Peliyagoda	Non Improved	-	0.0298
	Reloaded	-	0.0055
	15% lime mixed	2	0.0088
Organic Silt - Madiwela	Non Improved	-	0.2161
	Reloaded	-	0.0312
	5% cement mixed	4	0.1673

Table 2: $C_c / (1+e_0)$ values for non improved and improved peat



University of Moratuwa, Sri Lanka.
Electronic Theses & Dissertations
www.lib.mrt.ac.lk

Load / (kN)	$m_v / (\text{kN/m}^2)$					
	Peat	5% (cement)	10% (cement)	15% (cement)	15% (Lime)	Reloaded
10	0.01299	0.01181	0.01073	0.00350	0.01405	
20	0.00522	0.00948	0.00517	0.00262	0.00454	0.00027
40	0.00262	0.00118	0.00590	0.00259	0.00212	0.00037
80	0.00165	0.00156	0.00202	0.00215	0.00193	0.00052

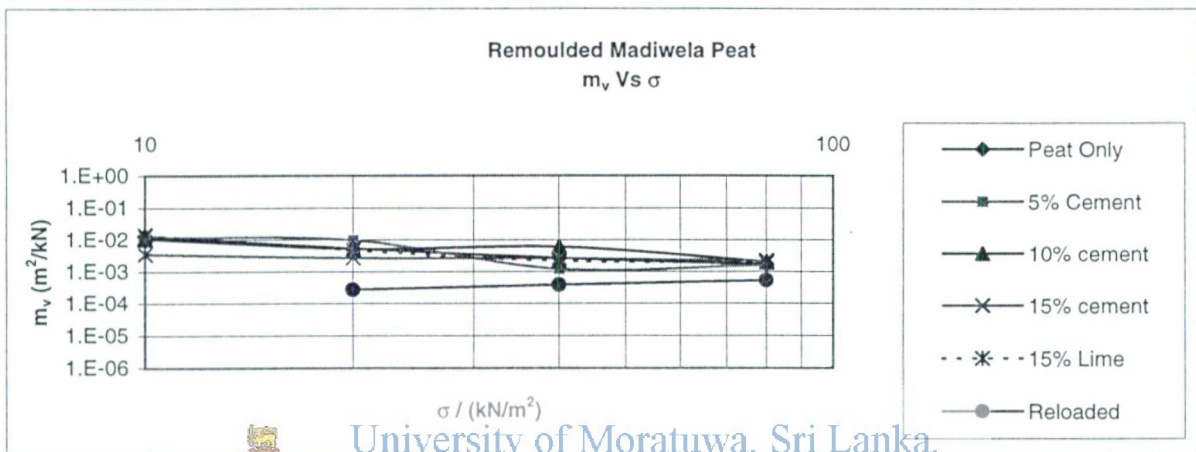

University of Moratuwa, Sri Lanka.

Electronic Theses & Dissertations

www.lib.mrt.ac.lk

Fig. 11: Effect on cement mixing on m_v for Madiwela Peat

Load / (kN)	$m_v / (\text{kN/m}^2)$		
	Peat	5% (cement)	Reloaded
10	0.01848	0.00030	
20	0.00558	0.00024	
40	0.00417	0.00017	0.00024
80	0.00179	0.00027	0.00024

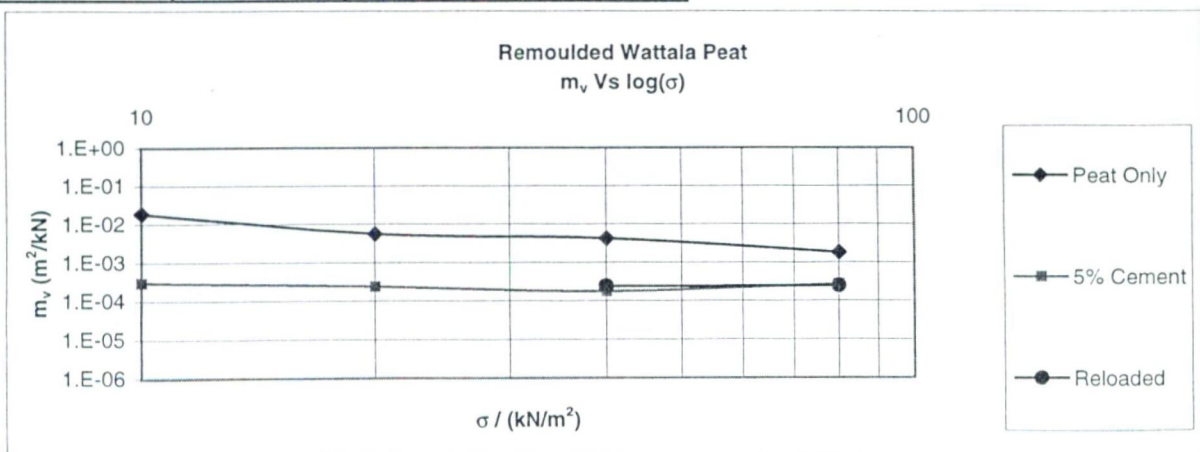

Fig. 12: Effect on cement mixing on m_v for Wattala Peat



Load / (kN)	$m_v / (\text{kN/m}^2)$		
	Peat Only	15% (lime)	Reloaded
6	0.01381	0.00271	
12	0.00387	0.00049	
24	0.00294	0.00054	
48	0.00198	0.00052	
20		1.40000E-05	0.00019
30		5.44000E-05	0.00050
40		5.44000E-06	0.00055
48		1.22000E-04	0.00076

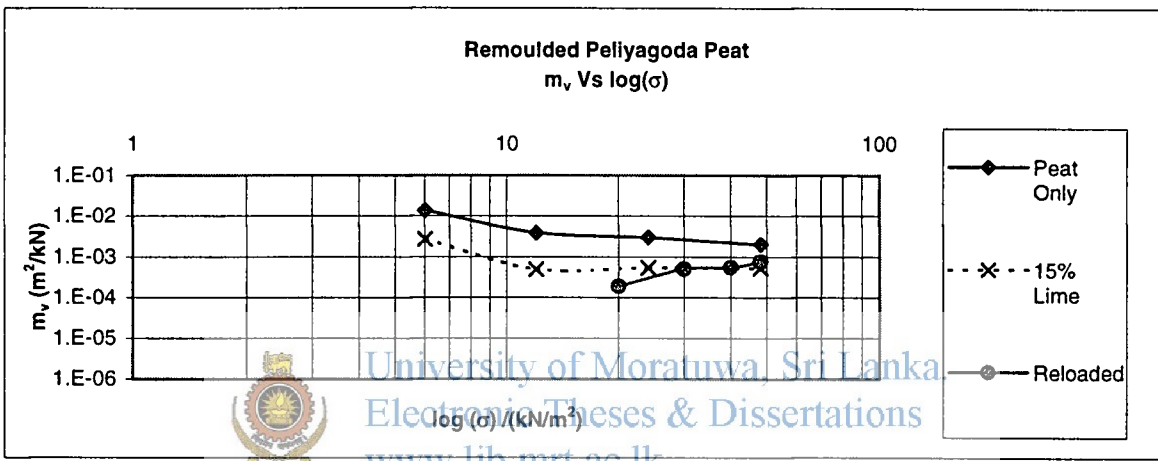

Fig. 13: Effect on Lime Mixing on m_v for Peliyagoda Peat

Load / (kN)	$m_v / (\text{kN/m}^2)$		
	Peat	5% (cement)	Reloaded
10	0.01005	0.00505	
20	0.00473	0.00240	0.00009
40	0.00262	0.00233	0.00035
80	0.00139	0.00134	0.00027

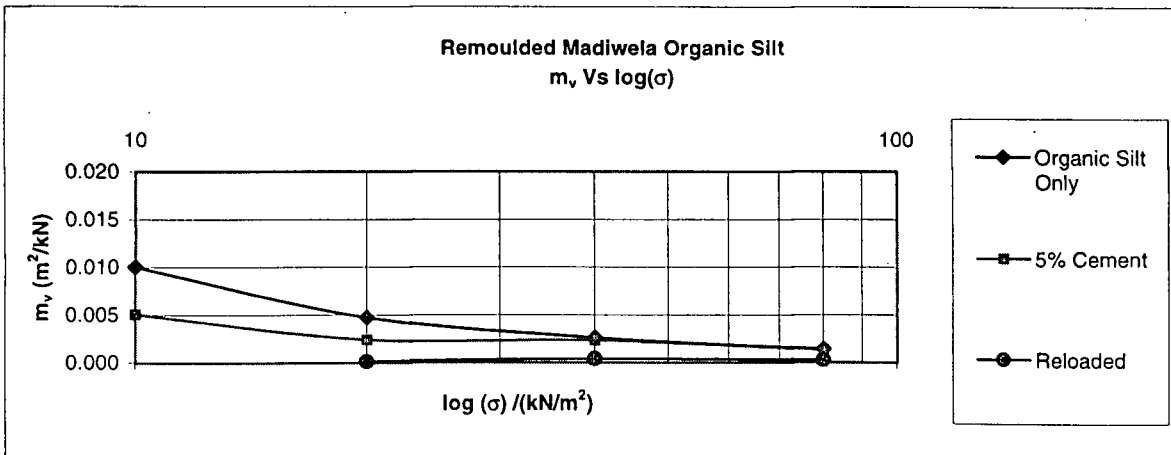

Fig. 14: Effect on Cement Mixing for Madiwela Organic Silt

Load / (kN)	$m_v / (kN/m^2)$				
	Peat Only	5% (cement)	10% (cement)	15% (cement)	15% (Lime)
20	0.00027	0.00016	0.00002	0.00002	0.00011
40	0.00037	0.00019	0.00009	0.00012	0.00025
80	0.00052	0.00021	0.00017	0.00028	0.00034

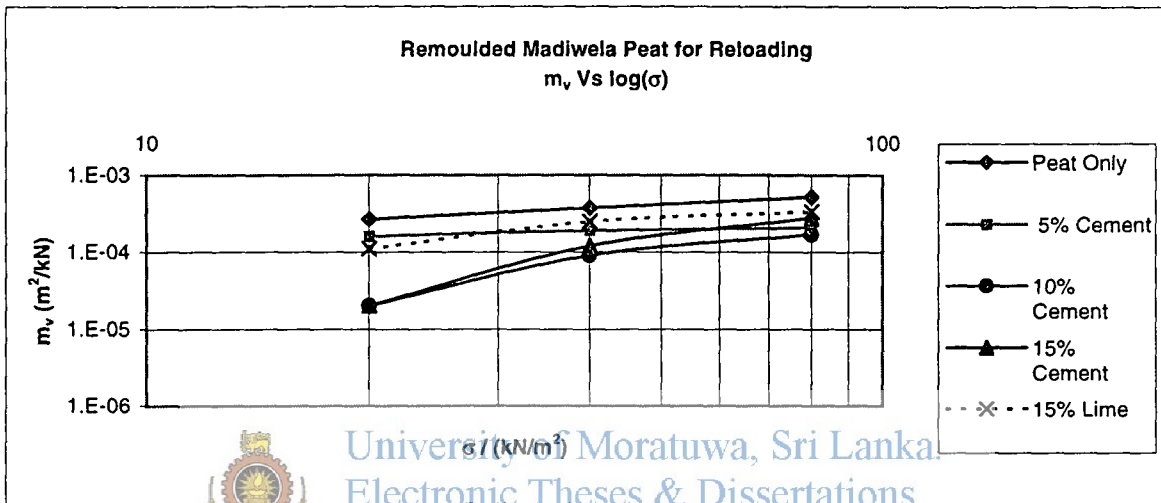

Fig. 15: Comparison of m_v over reloading increments (Madiwela peat)

Load / (kN)	$m_v / (kN/m^2)$	
	Peat Only	5% (cement)
20	0.00024	0.00007
40	0.00024	0.00010

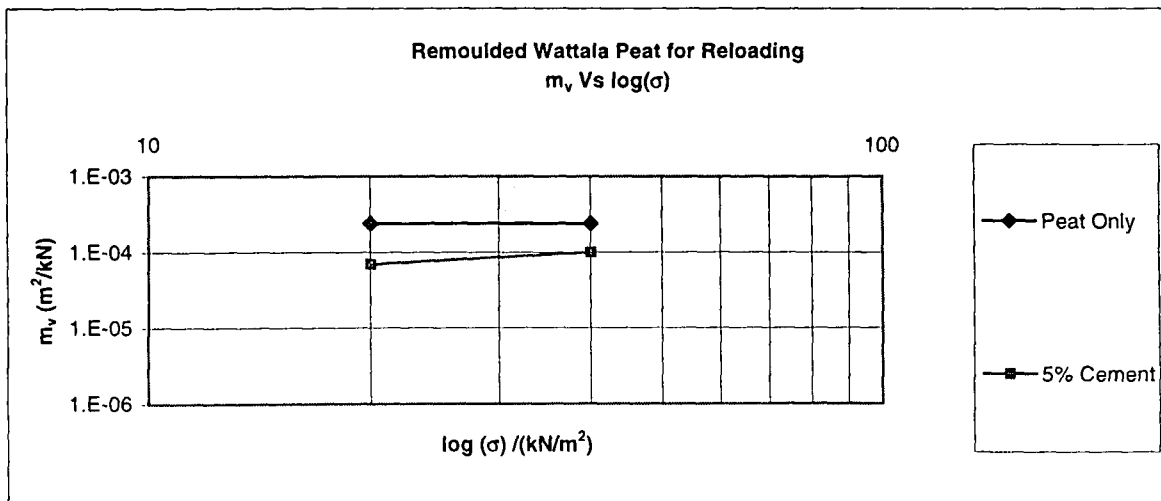

Fig. 16: Comparison of m_v over reloading increments (Wattala peat)

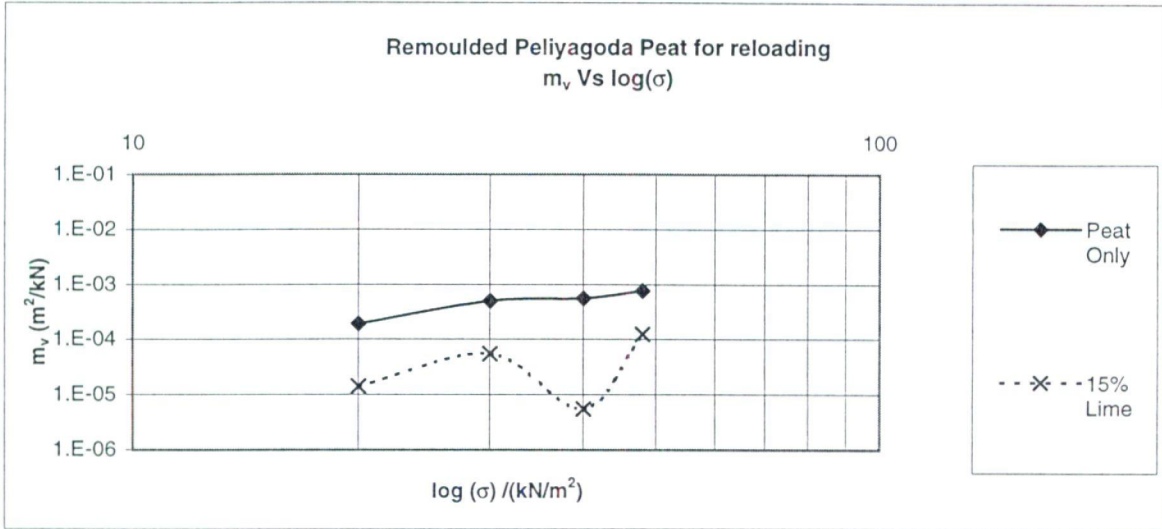

Fig. 17: Effect on Lime for Peliyagoda Peat for reloading

Load / (kN)	m _v / (kN/m ²)	
	Organic Silt	5% (cement)
20	0.00009	0.00006
40	0.00035	0.00004
80	0.00027	0.00008

University of Moratuwa, Sri Lanka.
 Electronic Theses & Dissertations
www.lib.mrt.ac.lk

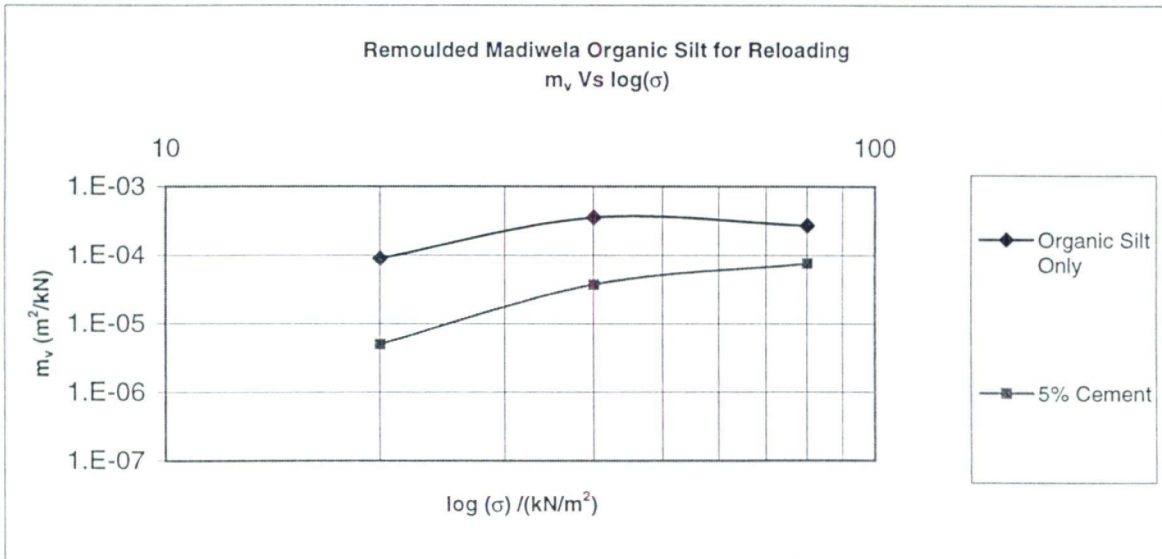

Fig. 18: Effect on Cement for Madiwela Organic Silt for reloading



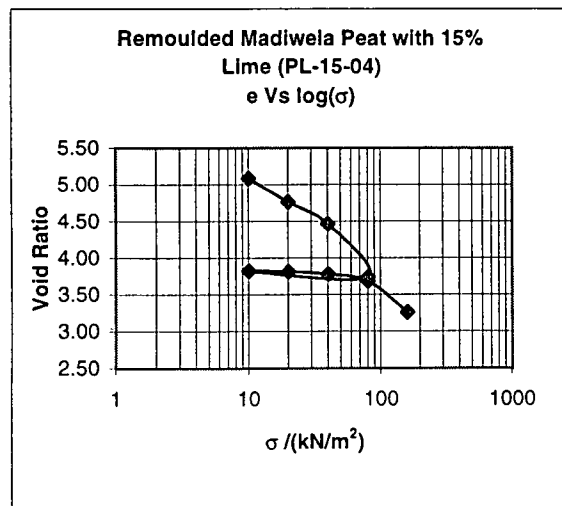
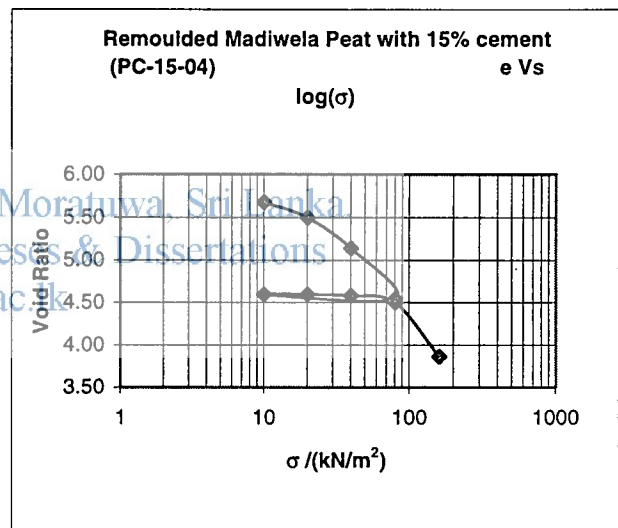
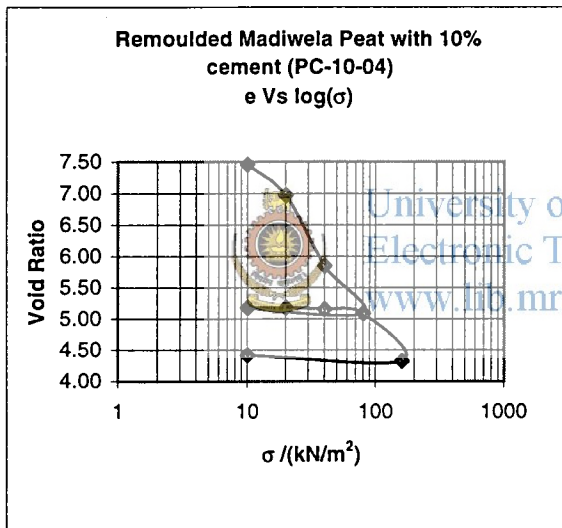
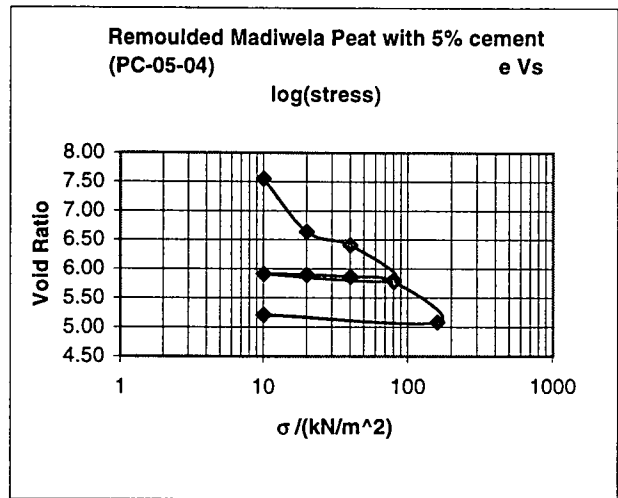
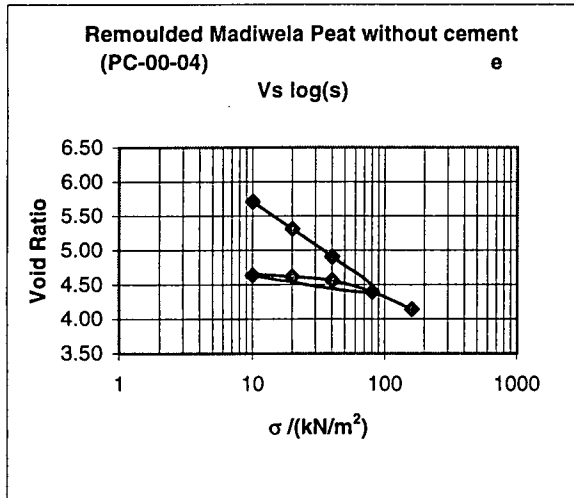

Figure 19: e vs log σ curves for Madiwela Peat (Peat and Peat mixed with different percentages of Cement / Lime)

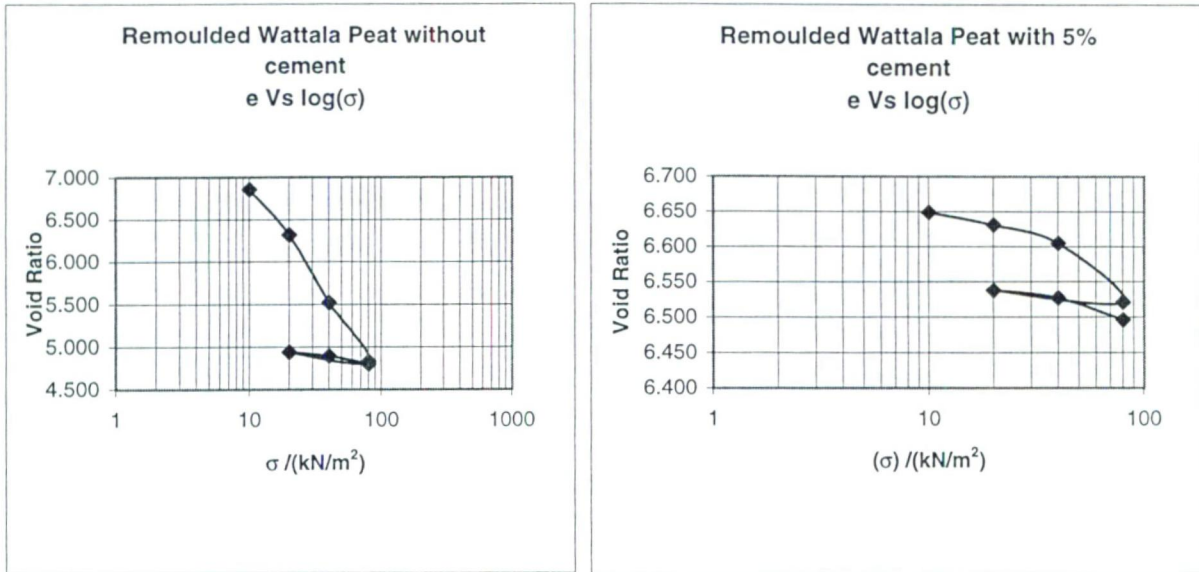

Figure 20: e vs log σ curves for Wattala Peat
(Peat and Peat mixed with 5% Cement)
www.lib.mrt.ac.lk

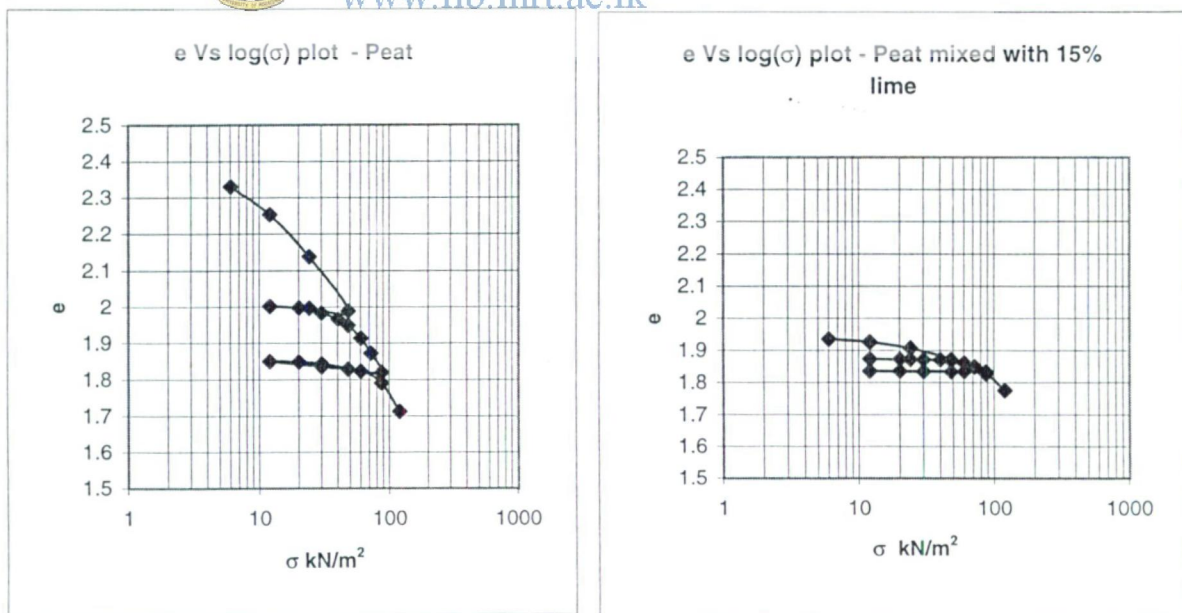
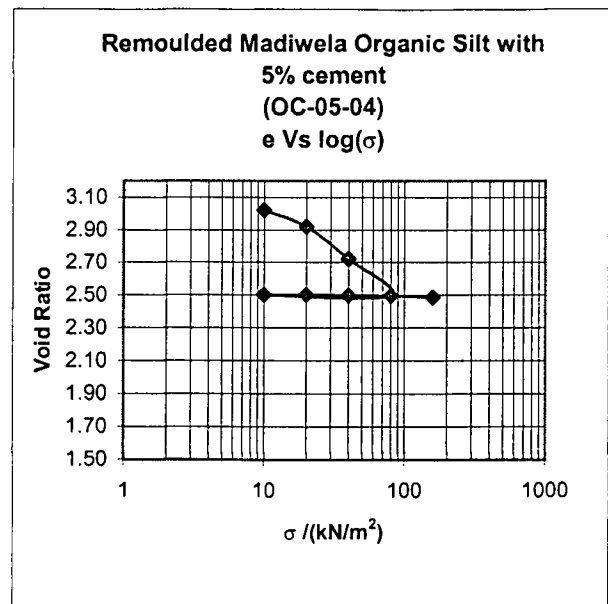
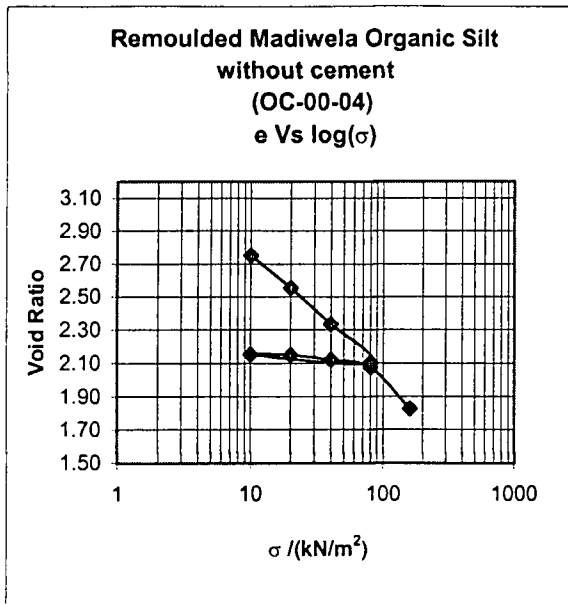

Figure 21: e vs log σ curves for Peliyagoda Peat
(Peat and Peat mixed with 15% Lime)





**Figure 22: e vs log σ curves for Madiwela Organic Silt
(silt and silt mixed with 5% Cement)**

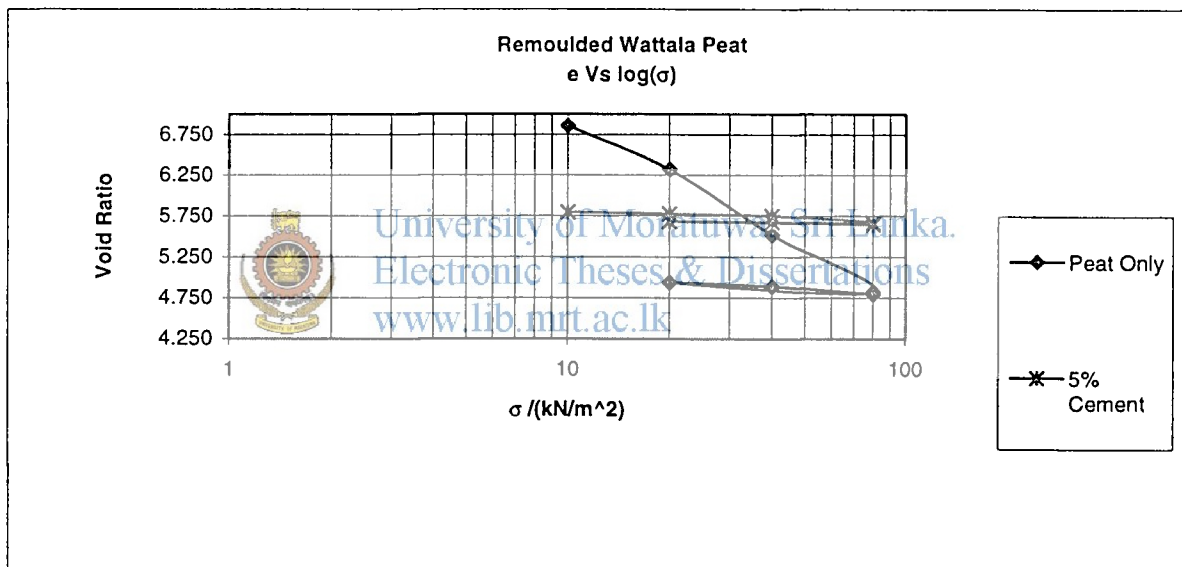

Figure 23: Comparison of e vs log σ plots - Wattala Peat

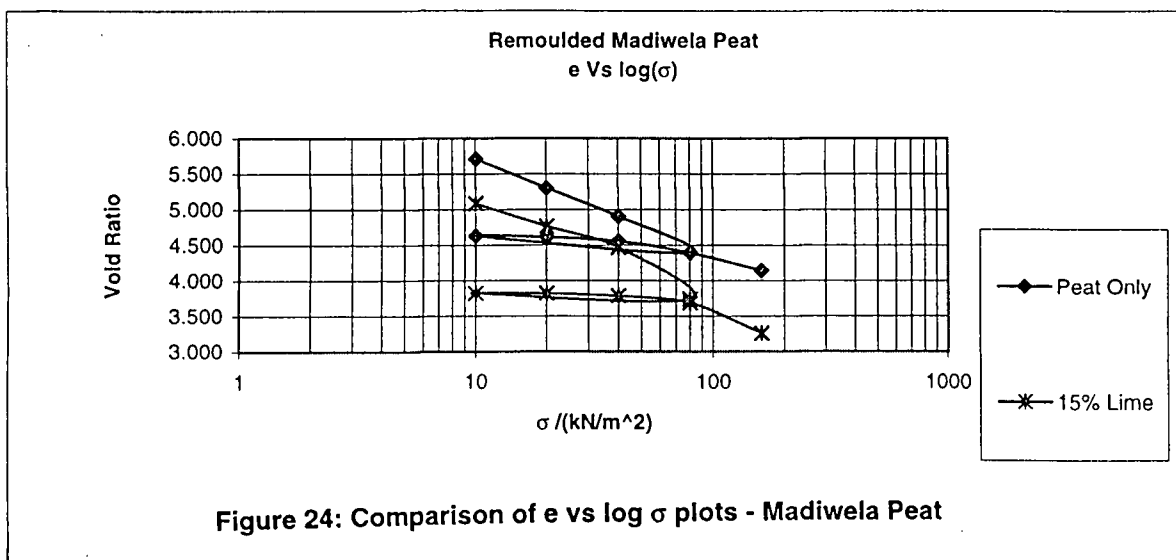

Figure 24: Comparison of e vs log σ plots - Madiwela Peat

CHAPTER 5

Comparison of improvements in secondary consolidation characteristics

5.1 Introduction

The effect of different improvement methods on the secondary consolidation characteristics was assessed by comparing the coefficient of secondary consolidation- c_{α} and its variation with time and the stress level.

Since peat shows very high secondary consolidation settlements, the coefficient of secondary consolidation (C_{α}) is an important property to be assessed in the improvement process. C_{α} values can be obtained from e vs $\log(t)$ curve drawn for two week long load increments. Typical graphs of e vs $\log t$ and C_{α} vs $\log t$ for Madiwela peat, Wattala peat, Peliyagoda peat and Madiwela organic silt, obtained from selected load increments are presented in Figures 25, 26, 27 and 28 respectively. It is clear that C_{α} value increases with time for peaty soil whereas a tapering off of the gradient was seen in organic silt.



University of Moratuwa, Sri Lanka
Electronic Theses & Dissertations
www.lib.mrt.ac.lk

5.2 Variation of C_{α} vs Stress Level

The variation of C_{α} with stress level is plotted for Madiwela peat for different percentages of cement and lime mixing in Figure 29. The C_{α} values for the reloading increments are also plotted in the same figure.

It is evident from these plots that mixing of cement or lime has not caused much improvement in the C_{α} values of Madiwela peat. An increase of C_{α} values were also observed for some cases. However, the C_{α} values for the reloading increments were much smaller. Thus, it is clear that the preloading will cause an improvement in secondary consolidation characteristics even in a fibrous peat.

The variation of C_{α} values with stress level is plotted for Wattala peat and for Wattala peat mixed with 5% cement in Figure 30. It is evident from these plots that the mixing of 5% cement has caused a significant reduction in C_{α} . This reduction is of the same order as the reduction achieved through preloading.

The behaviour of C_α values of Peliyagoda peat and Peliyagoda peat with 15% lime by weight are plotted in Figure 31 and it shows that the 15% lime mixing reduced the C_α value significantly. But the preloaded peat shows slightly larger improvement than in the case of 15% lime mixing.

The variation of C_α values with stress level is plotted for Madiwela organic silt and for Madiwela Organic Silt mixed with 5% cement in Figure 32. In order to evaluate the preloading effect, C_α values were also plotted in the same plot. This graph indicates that more significant reduction of secondary consolidation was achieved with 5% mixing than in the case of preloading. Therefore, it is clear that effect of cement mixing on secondary consolidation for Madiwela organic silt is more significant than that for the case of Wattala peat or Madiwela peat.

5.3 Variation of C_α with time in a Load Increment

The void ratio vs time plots presented in Figure 25, 26 and 27 for different peats indicates a very different shape when compared with conventional shapes observed for inorganic clays. The e vs values keeps decreasing at a increasing rate as time progresses. This implies that the coefficient of secondary consolidation C_α increases with time. Thus the plot of the variation of C_α vs time was thought to be useful.

The variation of C_α with time obtained from some selected typical load increments for the four types of soil samples are presented in Figure 33 to Figure 36.

Figure 33, present the case of Madiwela peat and Figure 34 present the behaviour of Wattala peat. The behaviour of Peliyagoda peat is shown in Figure 35 and the plot for the Madiwela organic silt is shown in Figure 36.

The behaviour of Madiwela organic silt is quite different from the other three soils. The increase of C_α with time seen in more organic soils (Madiwela peat, Wattala peat and Peliyagoda peat) was not observed in Madiwela organic silt. Its behaviour is much closer to that of an inorganic clay.

5.4 Variation of C_{α} with Overconsolidation Achieved in Preloading

Kulathilaka (1999) related the reduction achieved in C_{α} to the overconsolidation ratio achieved by preloading for the Sri Lankan peats. In that study the secondary consolidation coefficient in a loading increment was denoted by C_{α} and the secondary consolidation coefficient in the reloading increment was denoted by C'_{α} . The values were found for the same stress level and the ratio C'_{α} / C_{α} was evaluated. This was plotted against the overconsolidation ratio corresponding to the stress level.

Similar plots were obtained for the soils used in this research project. The graphs obtained for the four soil types are presented in Figure 37 to Figure 40.

From the Figure 37 corresponding to the Madiwela Peat, it can be seen that for the peat without any mixing, as the effect of overconsolidation diminishes (i.e., as the approaches unity) the coefficient of secondary consolidation (C'_{α} or C'_{α} / C_{α} ratio) increases. The effect is not so significant in Madiwela peat mixed with cement or lime. Therefore it appear to indicate that, if the Madiwela peat is mixed with cement and preloaded, the secondary consolidation effects will remain very low even if it is reloaded up to the maximum previous stress level. The improvement of coefficient of secondary consolidation with over consolidation ratio was also reported by Mesri et al (1997).

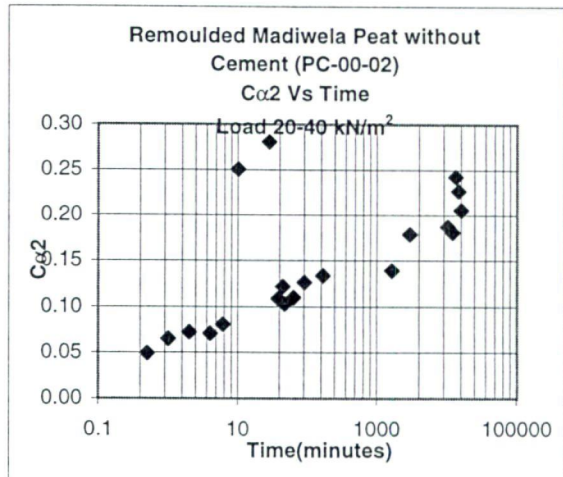
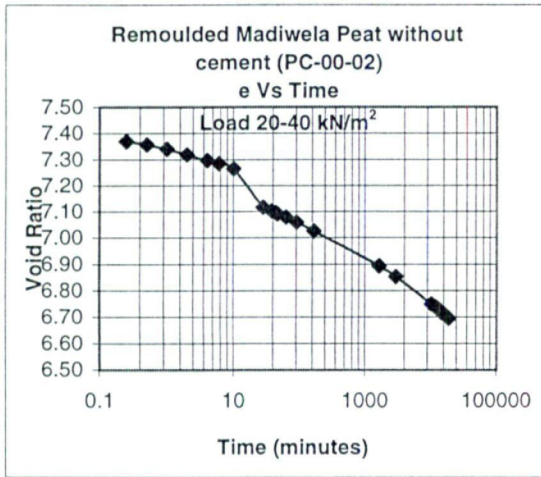

Figure 25: e vs $\log t$ and C_{α} vs $\log t$ plot for Madiwela Peat

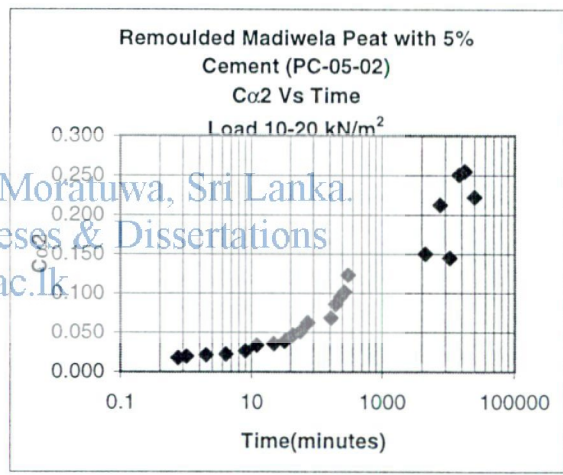
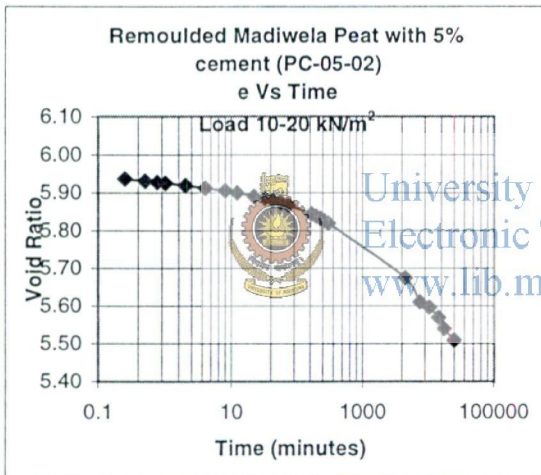

Figure 26: e vs $\log t$ and C_{α} vs $\log t$ plot for Madiwela Peat with 5% cement

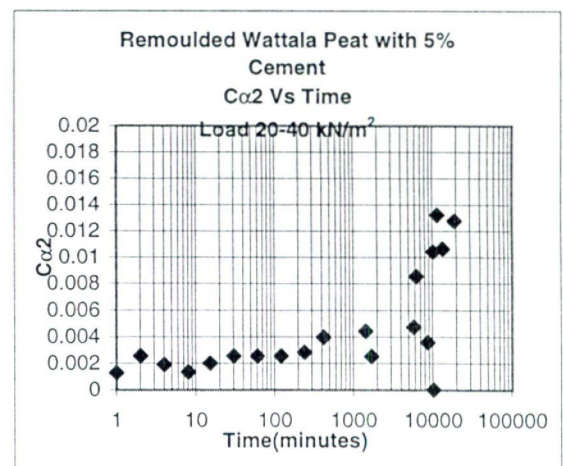
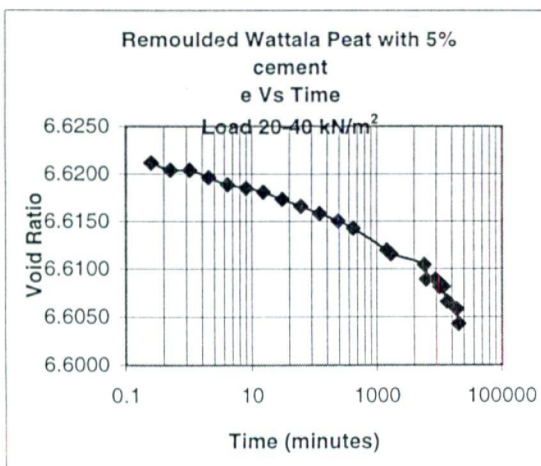

Figure 27: e vs $\log t$ and C_{α} vs $\log t$ plot for Wattala Peat with 5% cement



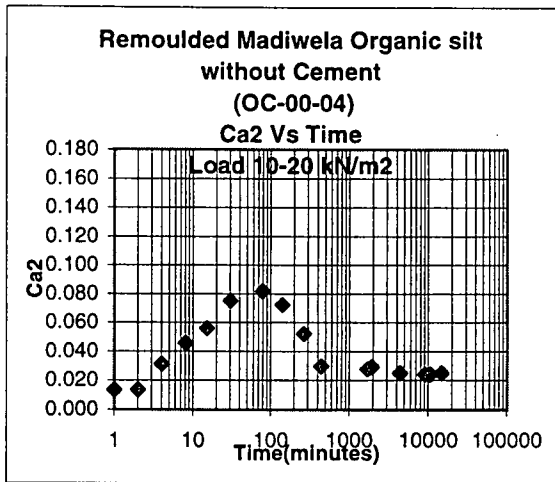
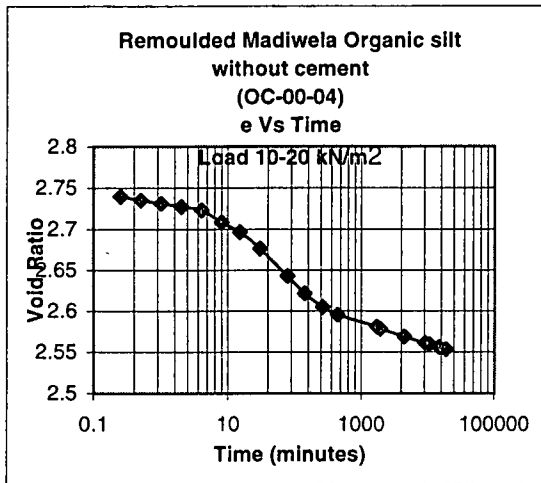

Figure 28: e vs log t and C_α vs log t plot for Madiwela Organic Silt with 5% cement



University of Moratuwa, Sri Lanka.
Electronic Theses & Dissertations
www.lib.mrt.ac.lk

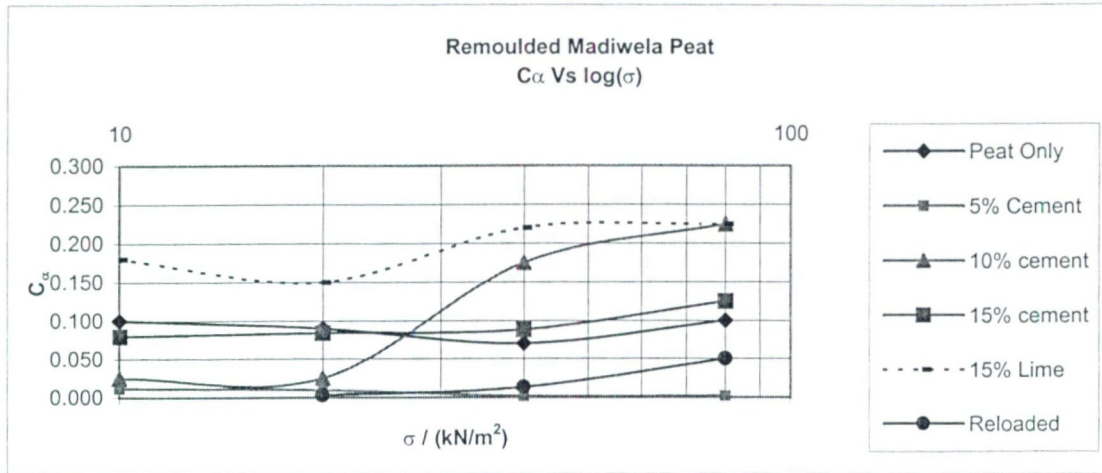

Figure 29: C_α vs log σ plot for Madiwela Peat

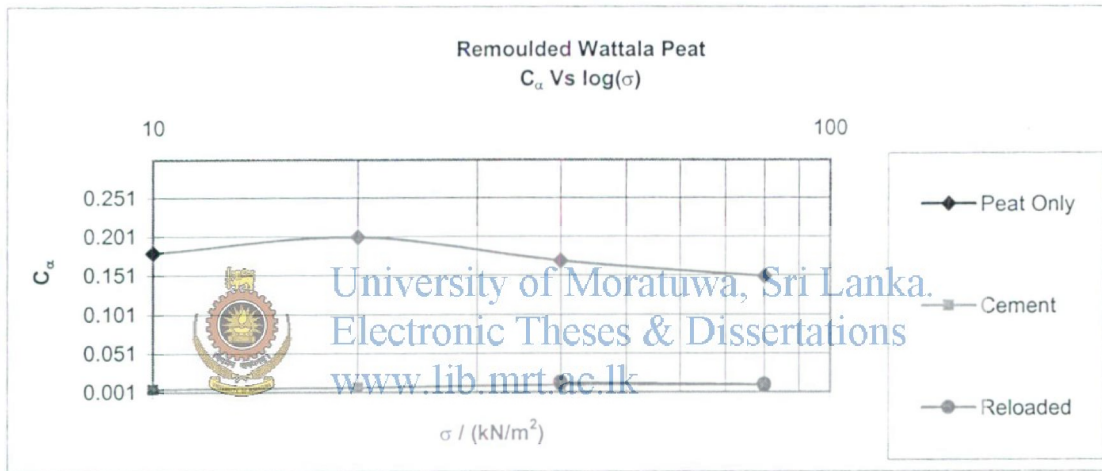

Figure 30: C_α vs log σ plot for Wattala Peat

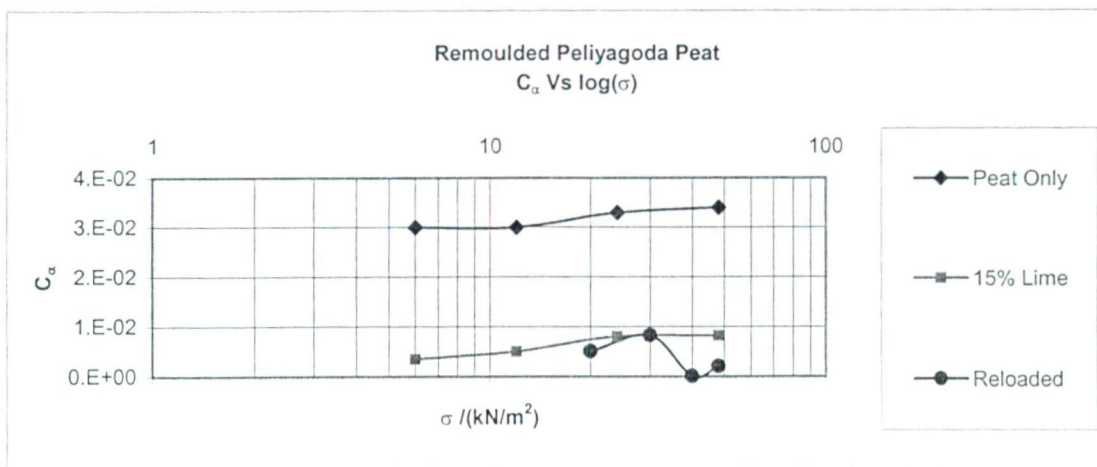
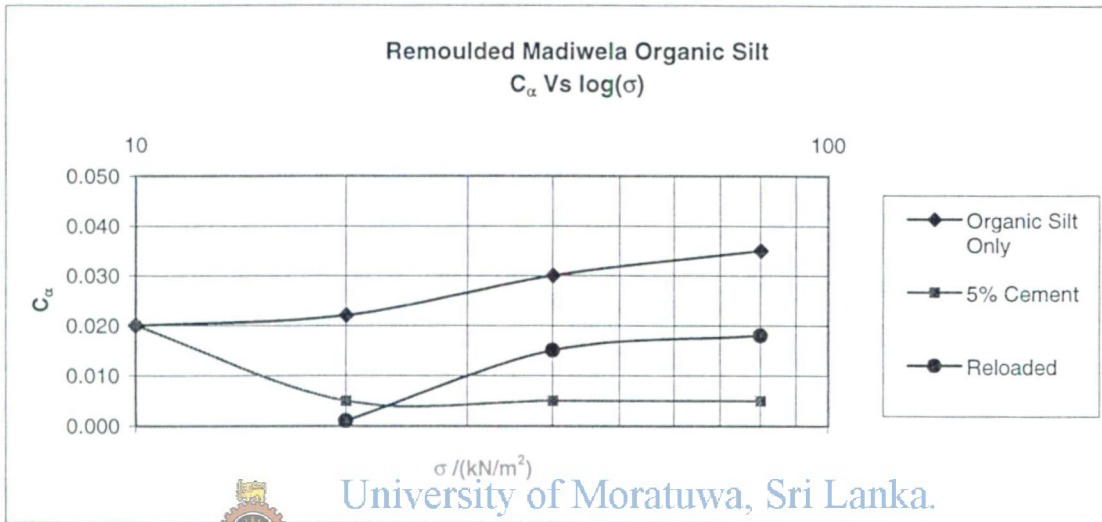

Figure 31: C_α vs log σ plot for Peliyagoda Peat





University of Moratuwa, Sri Lanka.
Electronic Theses & Dissertations
www.lib.mrt.ac.lk

Figure 32: C_{α} vs $\log \sigma$ plot for Madiwela Organic Silt

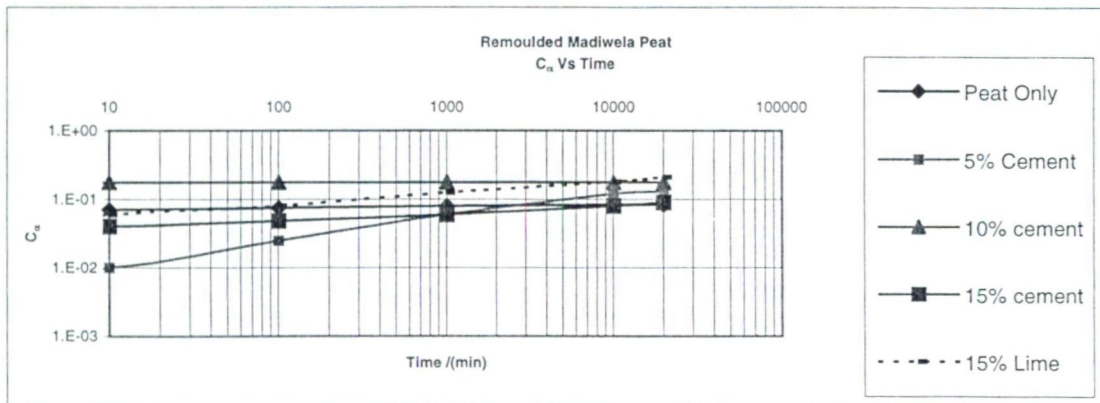

Figure 33: Variation of C_{α} with time for Madiwela Peat



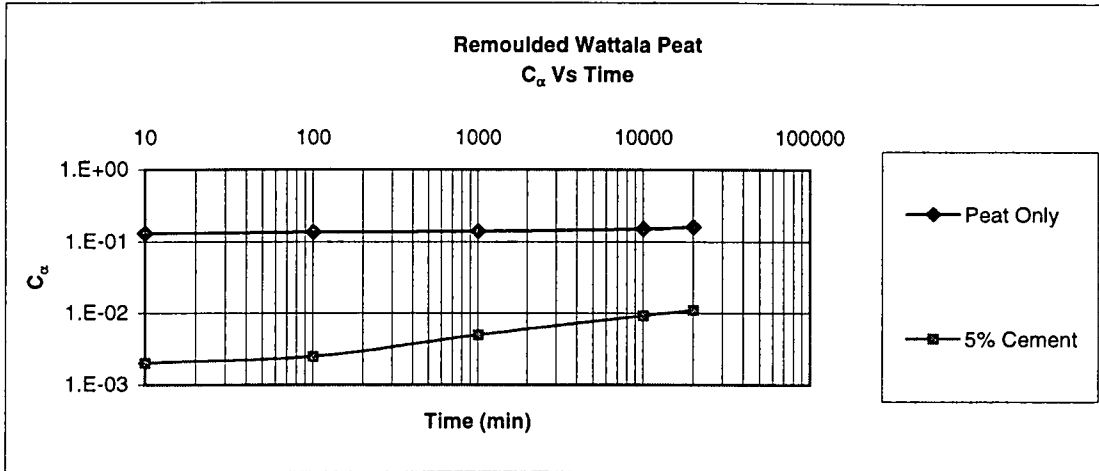

Figure 34: Variation of C_α with time for Wattala Peat

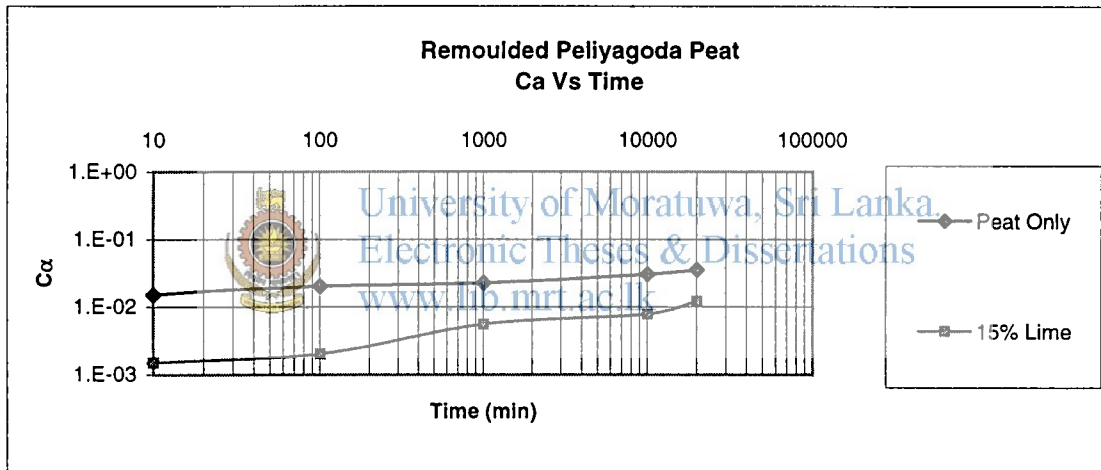

Figure 35: Variation of C_α with time for Peliyagoda Peat

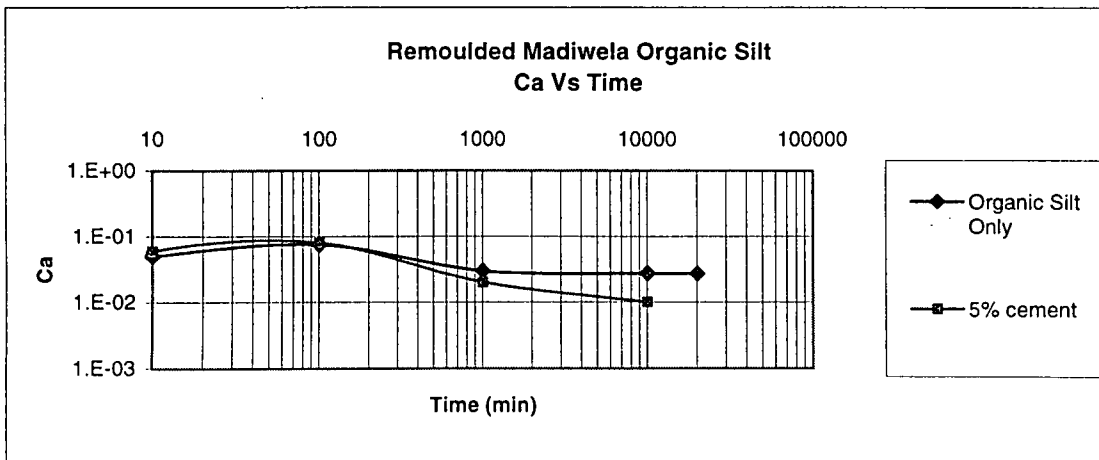
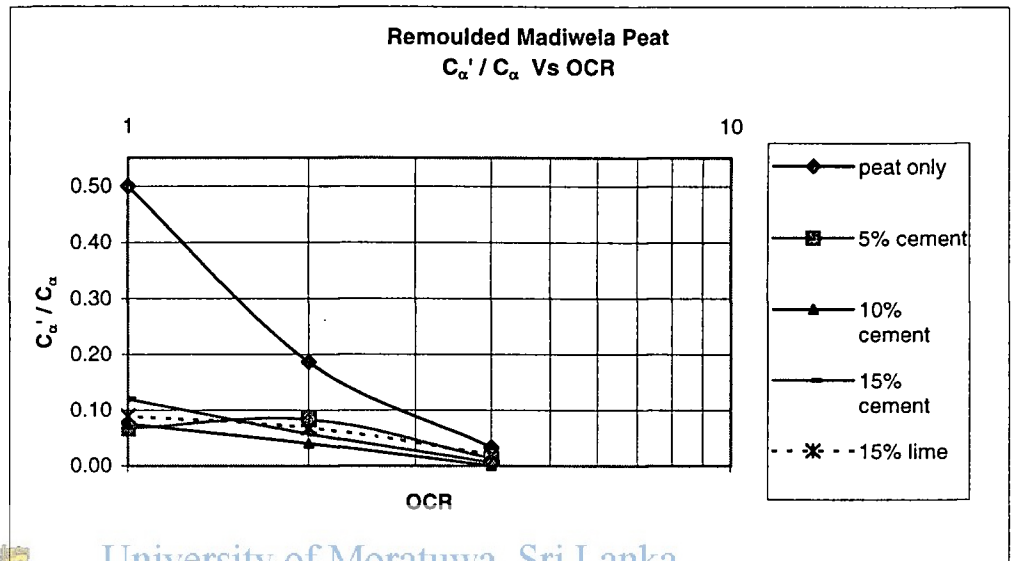

Figure 36: Variation of C_α with time for Madiwela Organic Silt

OCR	C_{α}' / C_{α}				
	peat only	5% cement	10% cement	15% cement	15% lime
4	0.0333	0.0125	0.0000	0.0060	0.0200
2	0.1857	0.0833	0.0400	0.0568	0.0682
1	0.5000	0.0667	0.0756	0.1200	0.0889



University of Moratuwa, Sri Lanka.

Electronic Theses & Dissertations

www.lib.mrt.ac.lk

Figure 37: Variation of C_{α}' / C_{α} vs Over consolidation Ratio for Madiwela Peat

OCR	C_{α}' / C_{α}	
	Peat only	5% cement
2	0.0650	0.8000
1	0.0588	0.7500

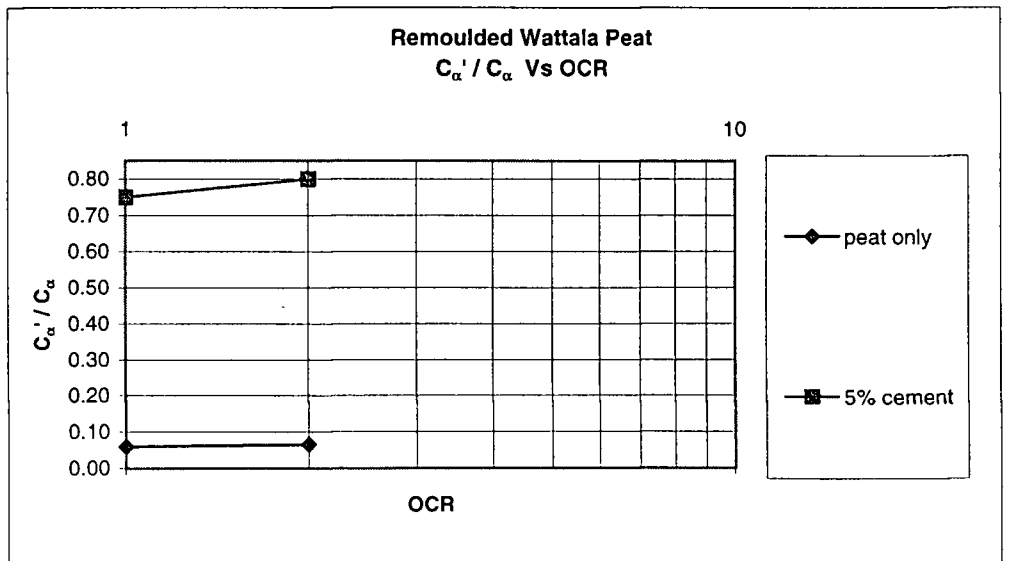
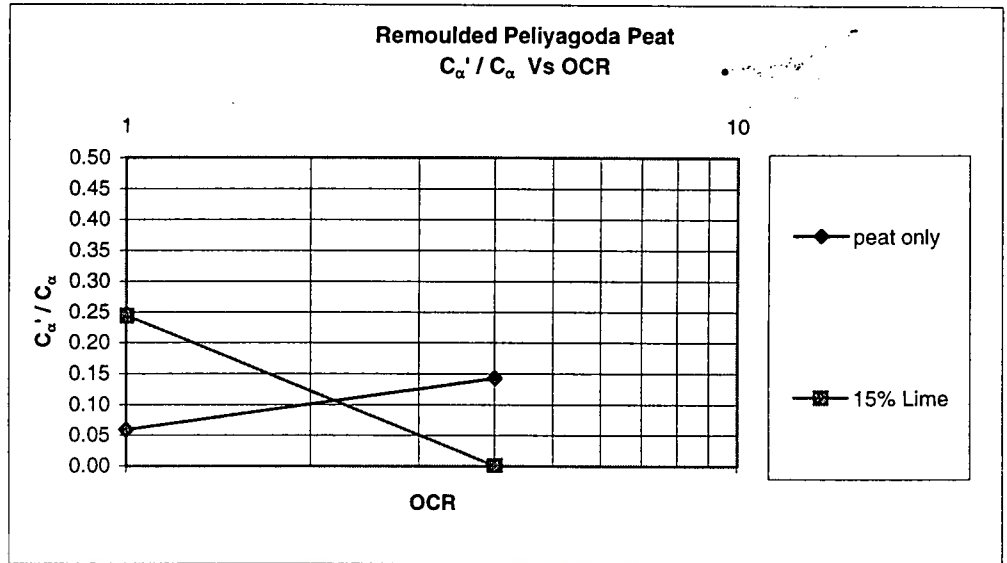

Figure 38: Variation of C_{α}' / C_{α} vs Over consolidation Ratio for Wattala Peat

OCR	C_{α}' / C_{α}	
	peat only	15% Lime
4	0.1429	0.0000
1	0.0588	0.2439



University of Moratuwa, Sri Lanka
Electronic Theses & Dissertations

Figure 39: Variation of C_{α}' / C_{α} vs Over consolidation Ratio for Peliyagoda Peat

OCR	C_{α}' / C_{α}	
	peat only	5% cement
4	0.0455	0
2	0.5000	0.1000
1	0.5143	0.0400

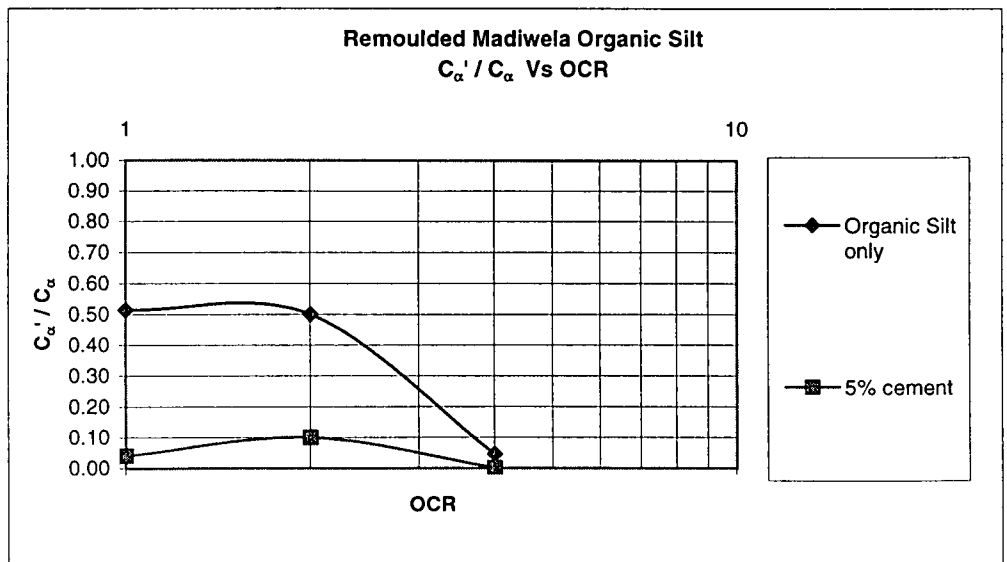

Figure 40: Variation of C_{α}' / C_{α} vs Over consolidation Ratio for Madiwela Organic Silt

CHAPTER 6

Comparison of improvement in shear strength characteristics

6.1 Improvement of undrained shear strength characteristics due to cement and lime mixing

Improvement of shear strength characteristics of peat mixed with different percentages of cementitious material can be evaluated through undrained cohesion values (C_u) obtained from the unconsolidated undrained triaxial (UU) tests. UU tests were conducted on specimen obtained from untreated peat and the peat treated with the addition of 5% cement, 10% cement, 15% cement and 15% lime after curing periods of two weeks and four weeks. When the soil was very soft, the preparation of triaxial samples was not possible. Samples bulged and failed under its own weight during the preparation. In such situations a laboratory Tor vane apparatus (Figure 41) was used to estimate the shear strength.

The specimen were subjected to Unconsolidated Undrained Triaxial tests at cell pressures of 50 kN/m², 75 kN/m² and 100 kN/m². The stress strain curves obtained and the Mohr circles derived for peat and peat mixed with different proportions of cement and lime and with two weeks curing are presented from Figure 45 to Figure 47. Table 3 shows the variation of Undrained cohesion (C_u) with the different types of samples. It is clearly evident from these results that with the increase of cement percentage and the increase of curing time cause a gradual increase of shear strength. But the improvements achieved were not as high as reported for inorganic clays (Brookes 1998). However, the peat mixed with 15% lime was very soft and could not be subjected to a unconsolidated undrained triaxial test.

Test	$C_u / (\text{kN/m}^2)$							
	Curing Time -4 weeks				Curing Time 2 weeks			
	Peat Only	5% (cement)	10% (cement)	15% (cement)	Peat Only	5% (cement)	10% (cement)	15% (cement)
Triaxial - UU	-	12.00	18.00	25.00	-	7.50	12.50	15.00
Tor Vane Test	5.36	-	-	-	2.14	5.36	-	-

Table 3: Improvement of Undrained Shear Strength due to Cement/Lime mixing

6.2 Improvement of Undrained shear strength due to preloading

In order to evaluate the improvement of shear strength characteristics of peat due to preloading, Madiwela undisturbed peat samples were subjected to Consolidated Undrained Triaxial test in the laboratory. The specimen were isotropically consolidated at different cell pressures and the deviator stress was applied under undrained conditions (Figure 42-44). The increase in undrained shear strength (ΔC_u) due to the increase in cell pressures ($\Delta \sigma_3$) was found and the ratio ($\Delta C_u / \Delta \sigma_3$) was evaluated. The variation of undrained consolidation C_u with consolidation is presented in Table 4. The ratio $\Delta C_u / \Delta \sigma_3$ is found to be around 0.2.

Consolidated Pressure / (kN/m ²)	C_u / (kN/m ²)
25	11
50	17
75	21

Table 4 - Improvement of Undrained Shear Strength due to Preloading



University of Moratuwa, Sri Lanka.
Electronic Theses & Dissertations
www.lib.mrt.ac.lk

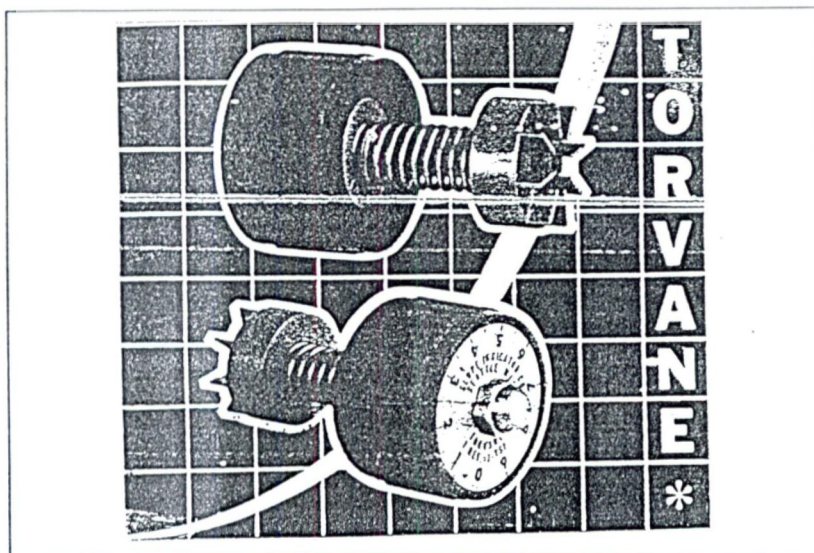
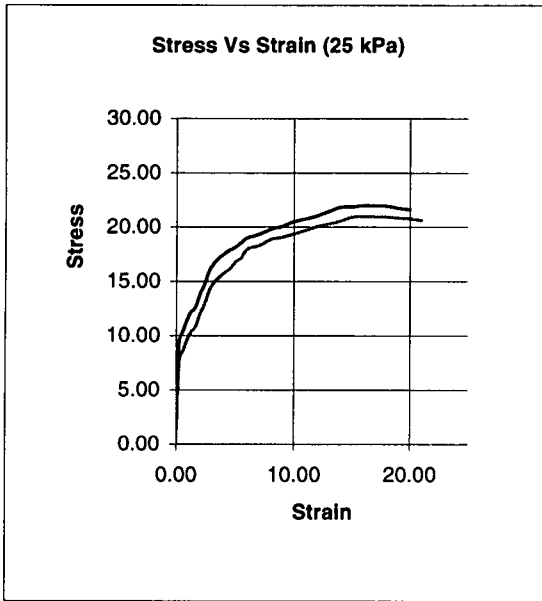
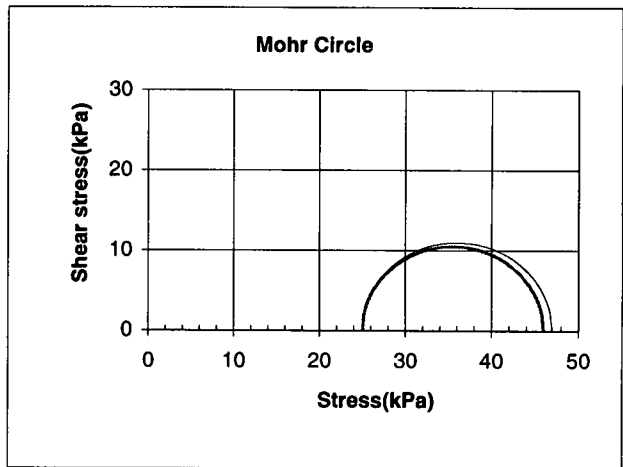

Figure 41: Tor Vane Apparatus





(a) Stress Strain Behaviour



Shear Strength Parameters	Cu kPa	<u>11.0</u>
	ϕ_u Deg	<u>0</u>

(b) Mohr Circle at failure

Figure 42: Consolidated Undrained Triaxial Test Results - Consolidation pressure 25 kN/m²

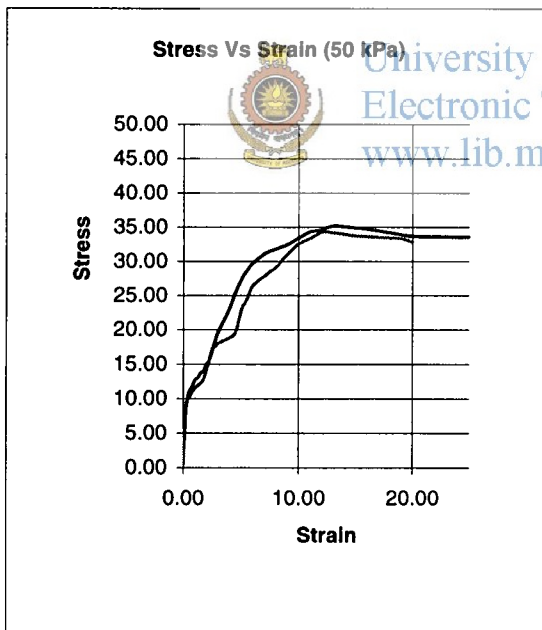

(a) Stress Strain Behaviour

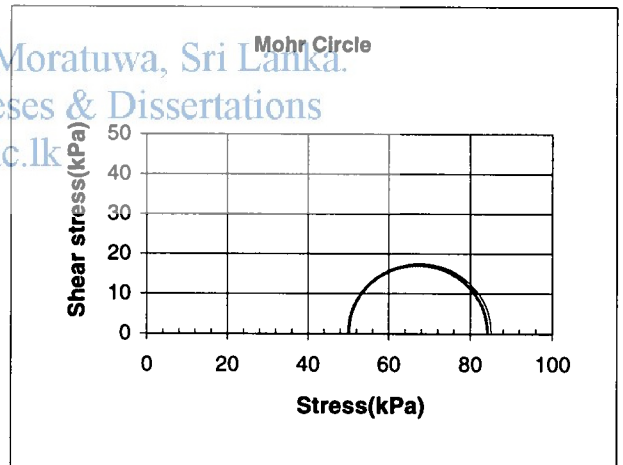

Shear Strength Parameters	Cu kPa	<u>16.0</u>
	ϕ_u Deg	<u>0</u>

(b) Mohr Circle at failure

Figure 43: Consolidated Undrained Triaxial Test Results - Consolidation pressure 50 kN/m²

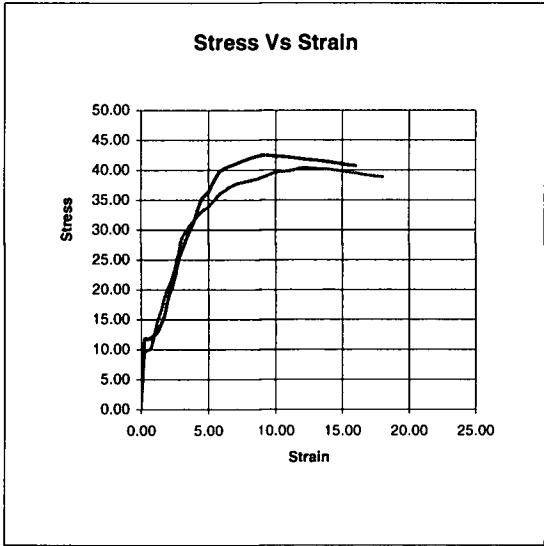

(a) Stress Strain Behaviour

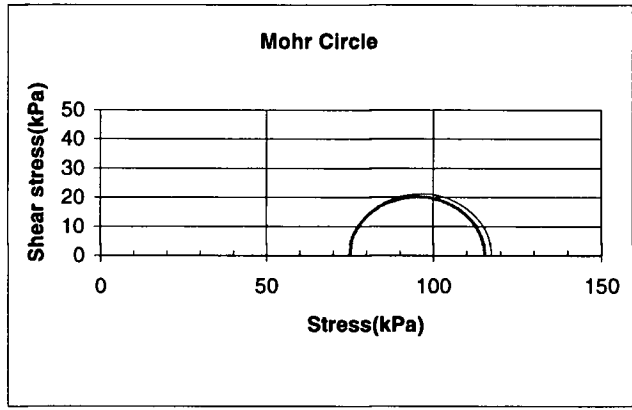

Shear Strength Parameters	Cu kPa	<u>20.0</u>
	ϕ_u Deg	<u>0</u>

(b) Mohr Circle at failure

Figure 44: Consolidated Undrained Triaxial Test Results - Consolidation pressure 75 kN/m²

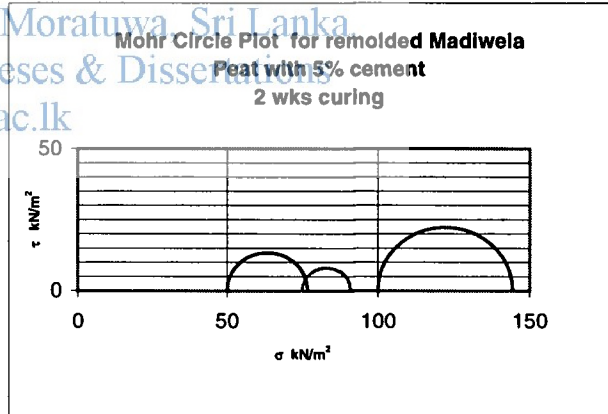
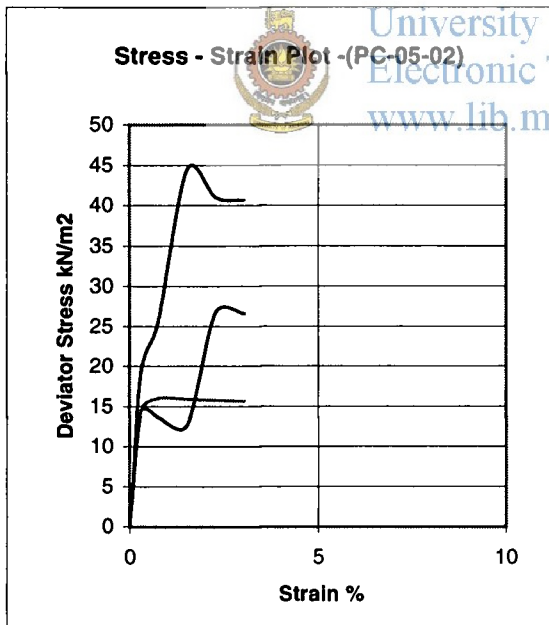

Shear Strength Parameters	Cu kPa	<u>10.0</u>
	ϕ_u Deg	<u>0</u>

Figure 45: Unconsolidated Undrained Triaxial Test Results - Peat mixed with 5% cement - 2 weeks curing

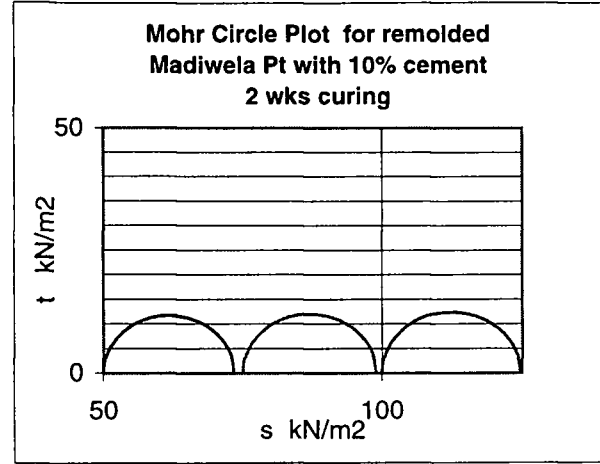
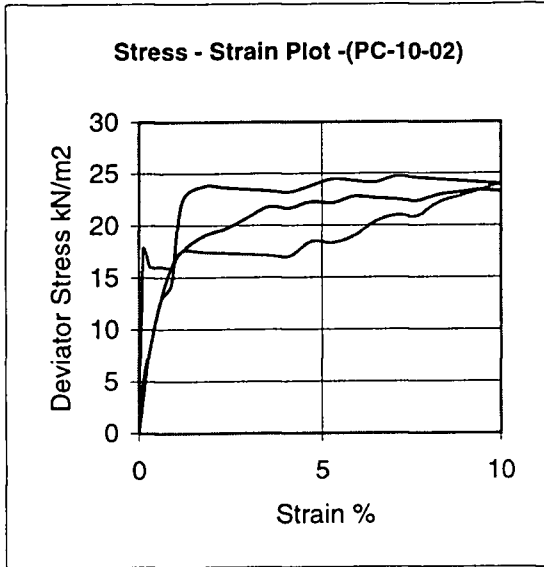

Shear Strength Parameters	Cu kPa	<u>12.0</u>
	ϕ_u Deg	<u>0</u>

Figure 46 : Unconsolidated Undrained Triaxial Test Results - Peat mixed with 10% cement - 2 weeks curing

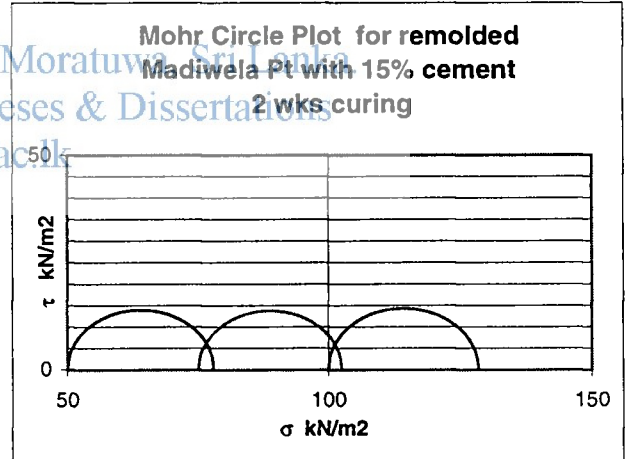
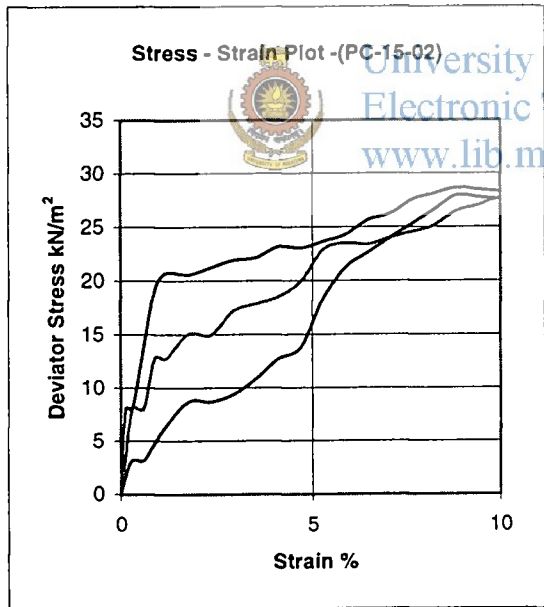

Shear Strength Parameters	Cu kPa	<u>14.0</u>
	ϕ_u Deg	<u>0</u>

Figure 47 : Unconsolidated Undrained Triaxial Test Results - Peat mixed with 15% cement - 2 weeks curing

CHAPTER 7

Modeling the Consolidation behaviour of peat

7.1 Background

Numbers of different theories were proposed to model the consolidation behavior of clays. The first rational theory developed was the Terzaghi's one dimensional consolidational theory (Terzaghi 1925).

Subsequently many alternate theories were developed. Some of them are modification to the Terzaghi theory and others were based on completely different rheological concepts. Models developed by Barden (Barden 1965, Barden 1968, Barden 1969), Gibson and Lo (1961), Bjerrum (Bjerrum 1967) and Garlander (Garlander 1972) and some to be named.

An attempt was made in this project to model the consolidation behavior of both the natural peat and peat improved by cement mixing. Due to the time restriction it was possible to study only the application of the Terzaghi model in detail. Although there are limitations such as ignoring the presence of secondary consolidation, the Terzaghi's one dimensional consolidation theory is still the foundation of engineering practice.

Attempts were also made to derive the Bjerrum curves (of variation of void ratio with consolidation pressure and time) for peat through experimental data.

The settlements taking place during the primary consolidation stage are accompanied by the dissipation of excess pore water pressure. As such, any tests conducted to model the consolidation behaviour of the soil should be done with the measurements of both the settlements and the pore water pressures. In the conventional laboratory consolidation test only the settlements are measured. Rowe cell (Rowe and Barden 1966) provides an arrangement to measure the pore water pressure at the bottom undrained boundary of the sample and the overall settlement of the sample. As the Rowe cell in the laboratory was not in working order, a laboratory setup was developed to conduct the consolidation tests with simultaneous pore water pressure and settlement measurements.

7.2 Development of the laboratory setup for simultaneous measurement of pore water pressure and settlement

In the new laboratory setup a GI pipe of 69.5mm diameter and the height of 85mm was used as the consolidation ring. Drained conditions were provided at the top boundary of the sample while undrained conditions were established at the bottom boundary. Thus the setup has an upper plate containing four holes to facilitate drainage and the bottom plate consist of one hole at the center to be connected to the pore water pressure measuring arrangement. The air entrapped in the tube connecting the bottom of the sample to the pore water pressure-measuring diaphragm was flushed out and it was filled with water initially. Top plate and the top porous plate were made to a slightly smaller diameter facilitating the free movements inside the cylinder and the bottom plate was made water tight by fixing two rubber "O" rings around. The bottom plate has a threaded end to facilitate fixing to the triaxial base. The pore water pressure measurement was done through the diaphragm system used in the triaxial setup. In these test, loading was applied using a direct shear-loading frame. A schematic diagram of the components are shown in Figure 47 and the arrangement of the loading system is presented in Figure 48.

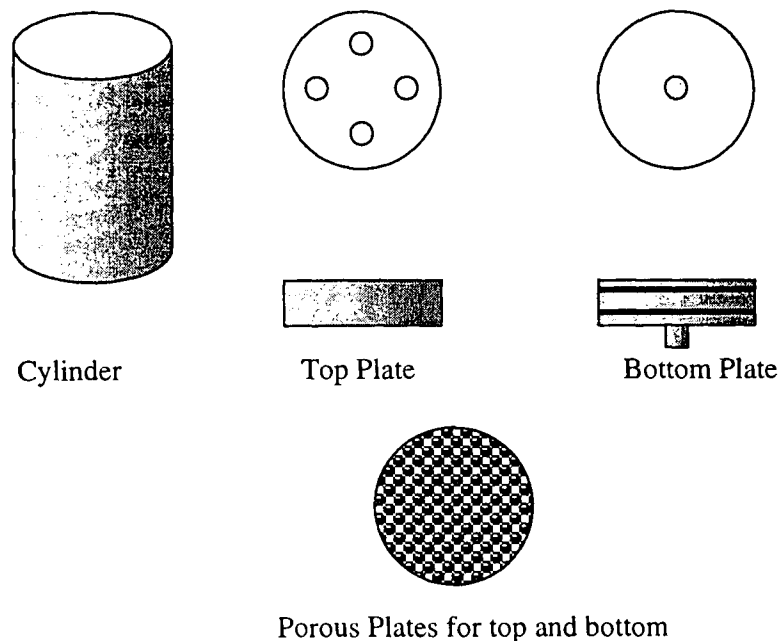

Figure 47 - Components of the test setup

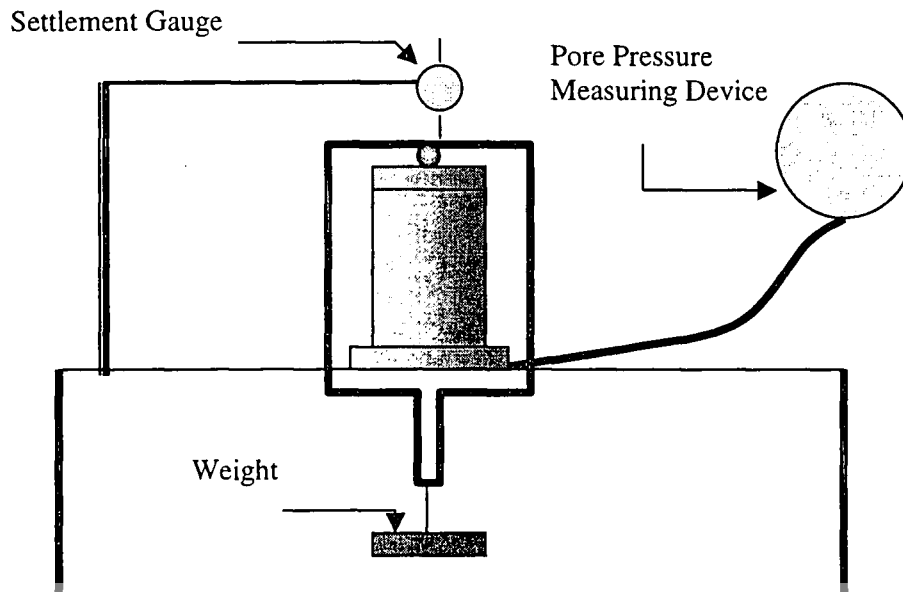

Figure 48 - Test setup to measure PWP and Settlement

University of Moratuwa, Sri Lanka.

Electronic Theses & Dissertations

www.lib.mrt.ac.lk

Photographs of the components of the system are presented in Figure 49 (a) to (e) and the complete setup is presented in Figure 50.

7.3 Testing Procedure and Test Results

The specimen was subjected to a load of 40 kN/m^2 by applying a weight directly using the load hanger. Settlements were measured using a dial gauge as shown in the Figure 48 and pore water pressure measurement was also done simultaneously.

Settlement and the pore water pressure values obtained through remoulded Madiwela peat without cement mixing and with 10% cement mixing were plotted in Figure 51 and Figure 52 respectively. A major shortcoming in the pore water pressure measuring system due its slow response is evident in the results. Attempts were make to minimize this by reducing the lengths of the connecting tubes. Despite those efforts the maximum pore water pressure was developed only after 4 minutes from initial loading. Some pore water pressure dissipation would have occurred during this period and thus the maximum recorded pore water pressure was somewhat lower than the applied stress of 40 kN/m^2 . Figure 51 and Figure 52 show that

the excess pore water pressure has dissipated completely within a 200 – 400 minutes period. Therefore, it can be deduced that the primary consolidation has finished by that time.

It could also be seen that the settlements continue for a long time even after the complete dissipation of the excess pore water pressure. This continuing settlement can be attributed to secondary consolidation effects. However, the time for 100% consolidation obtained by the measurement of pore water pressures did not agree exactly with the time for 100% consolidation obtained from Casagrande's (1940) empirical construction.



University of Moratuwa, Sri Lanka.
Electronic Theses & Dissertations
www.lib.mrt.ac.lk

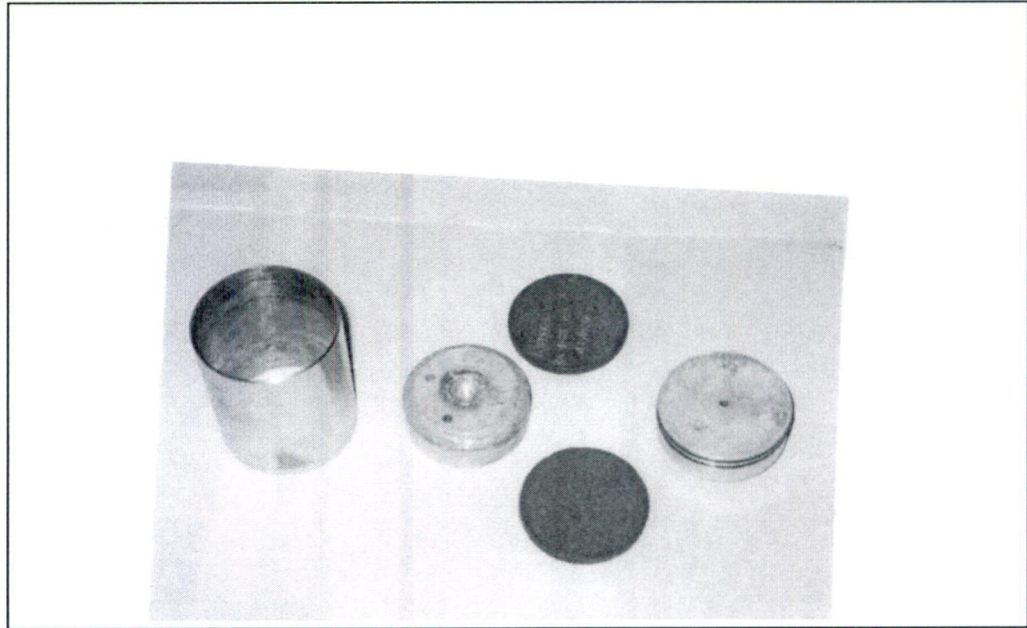

Figure 49(a): Cylinder with top and bottom plates

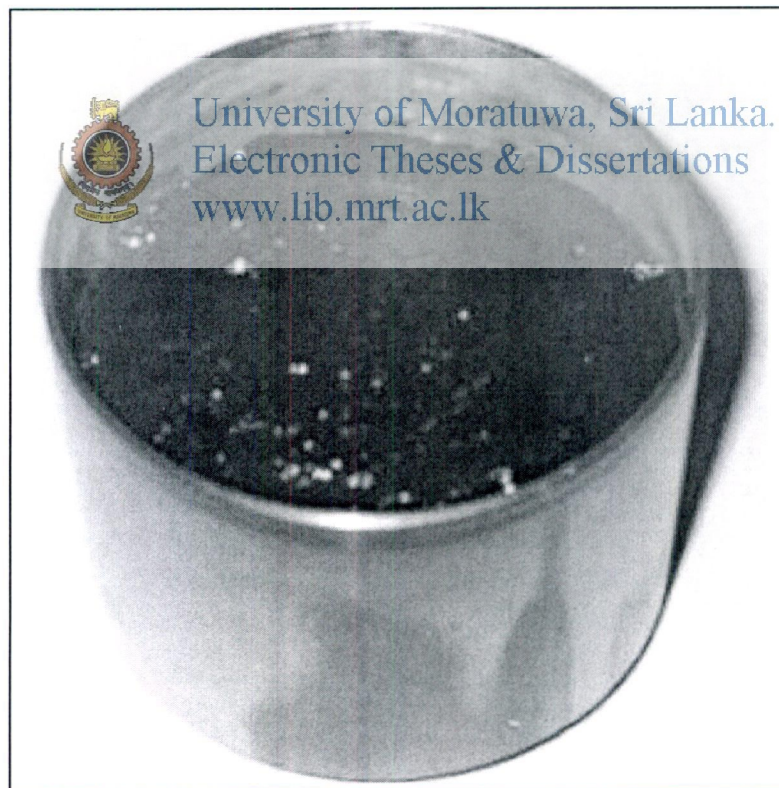

Figure 49(b): Cylinder with the peat sample



Figure 49(c): Cylinder with the top plate

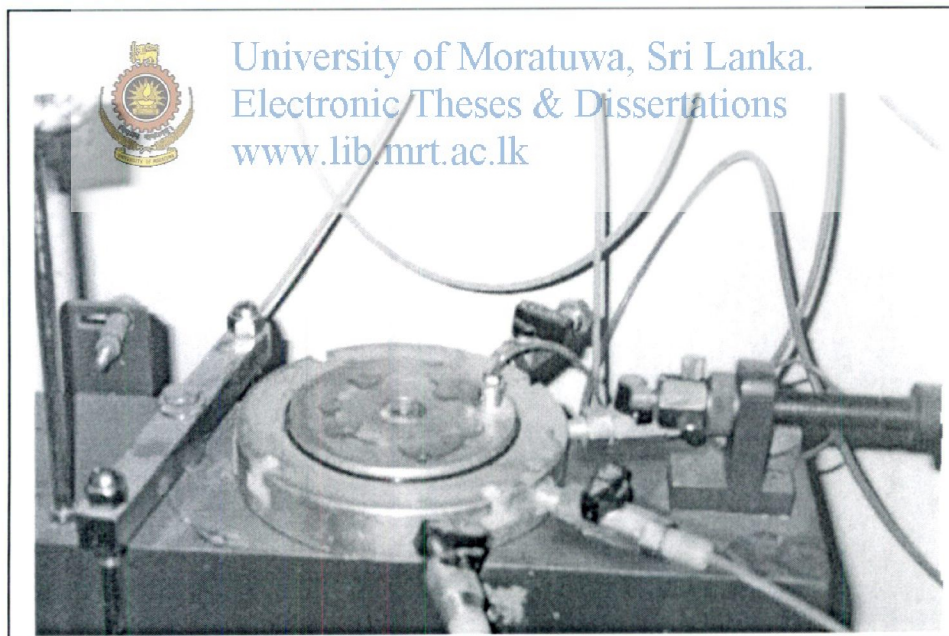

Figure 49(d): Triaxial base with pore water pressure measuring system

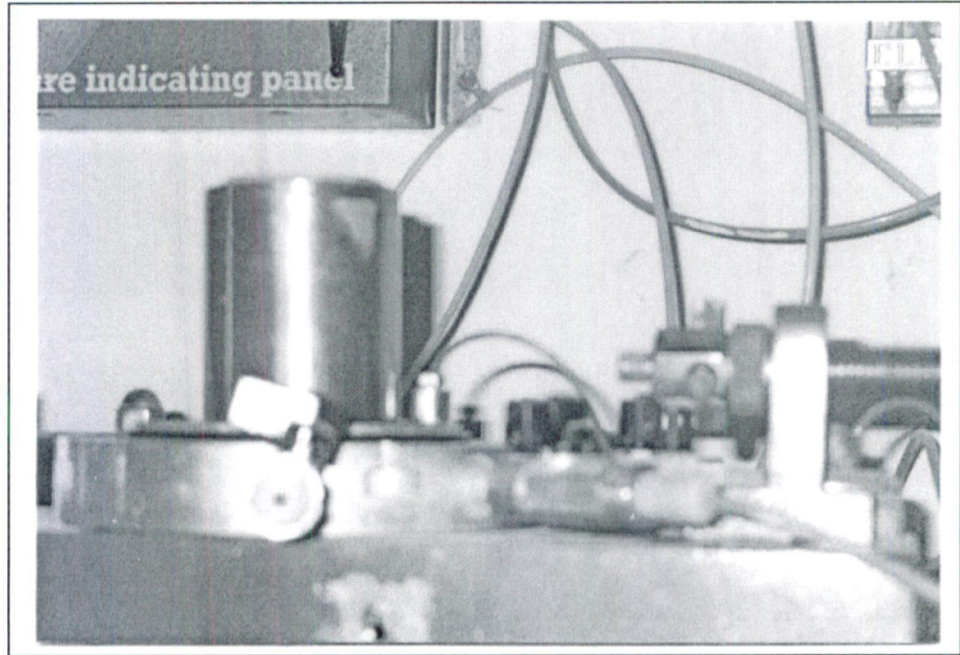

Figure 49(e): Peat sample with the triaxial base



University of Moratuwa, Sri Lanka.
Electronic Theses & Dissertations
www.lib.mrt.ac.lk



Figure 50: Complete Loading Setup

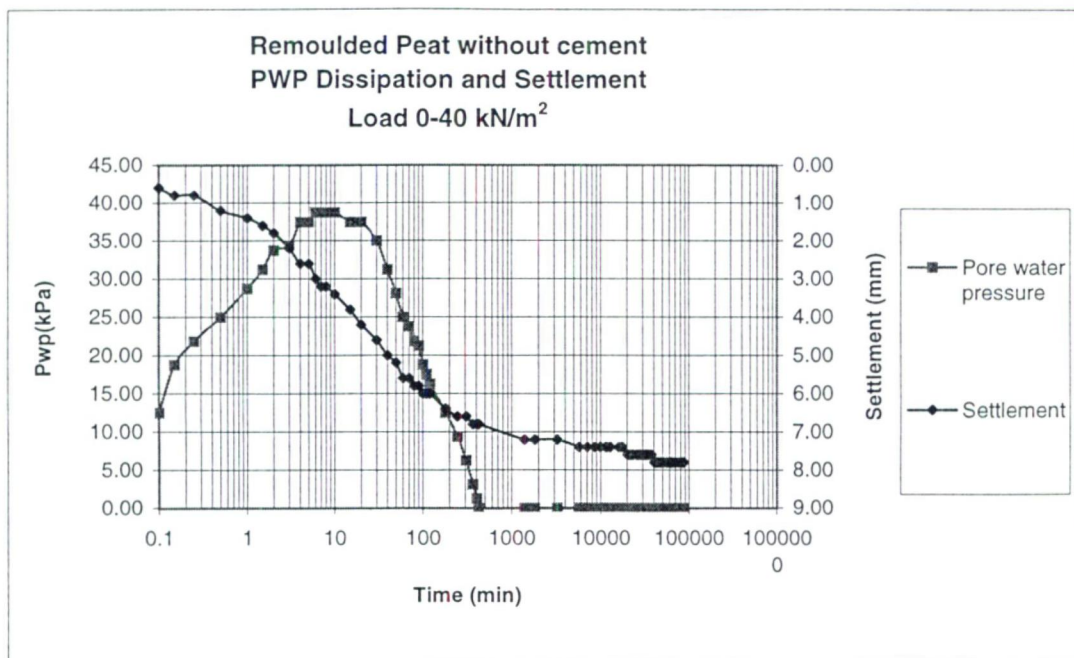

Figure 51: Settlement and Pore water pressure variation for Remoulded Madiwela Peat without cement



University of Moratuwa, Sri Lanka.
Electronic Theses & Dissertations

www.lib.mnu.ac.lk

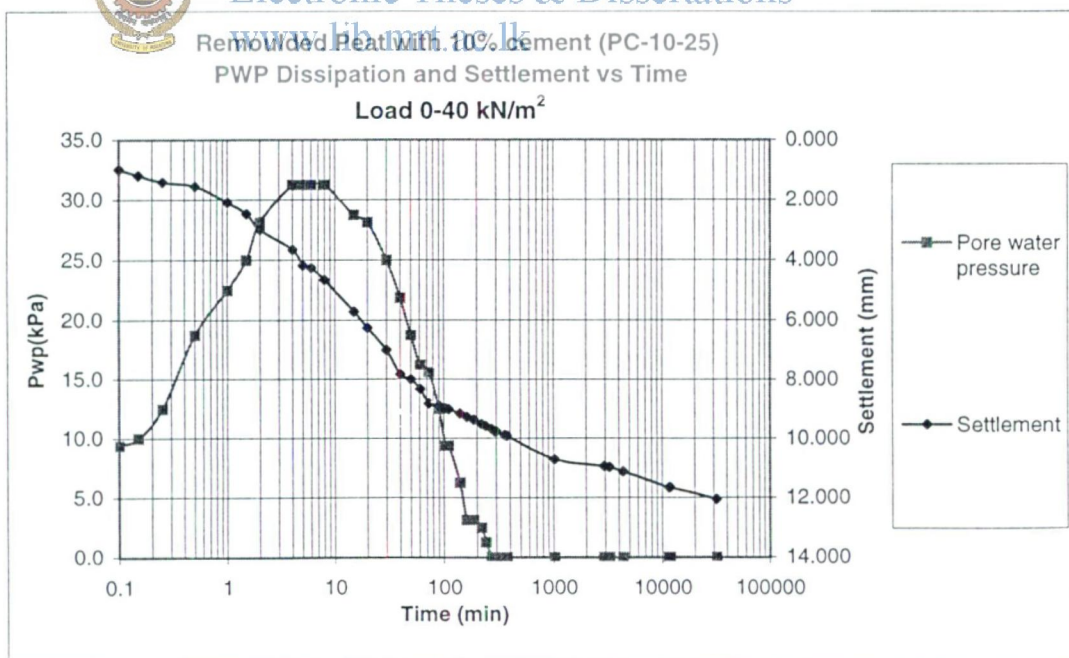

Figure 52: Settlement and Pore water pressure variation for Remoulded Madiwela Peat with 10% cement



7.4 Back analysis of the test using Terzaghi model

7.4.1 Fundamental of the Terzaghi's model

The main assumptions made in the formulation of the Terzaghi model are

- The soil is homogeneous and fully saturated.
- The compressibility of both soil particles and water is negligible.
- The problem is one dimensional with respect to both soil strains and the movement of water.
- Darcy's law applies, with a constant coefficient of permeability within any load increment.
- The relationship between void ratio and the effective stress is linear within any load increment, and independent of time.
- The total stress is constant and layer thickness does not change appreciably during a load increment.

Considering that the change in volume is due to the discharge of pore water, the relation ship



$$C_v \cdot \frac{\partial^2 u}{\partial z^2} = \frac{\partial u}{\partial t}$$

Could be derived. There;

u = excess pore water pressure at point

Z = Distance to the point

t = Time

C_v = the coefficient of consolidation

The above equation could be solved under the prevailing boundary conditions.

If the consolidation layer is having permeable boundary at top and bottom.

At $t = 0$ $u = u_0$ for all z

At $t = 0+$ $u = 0$ for $Z = H$

At $t = 0+$ $u = 0$ for $Z = 0$

If the top boundary is permeable and the bottom boundary impermeable as in our experimental setup.

$$\begin{aligned} t = 0 & \quad u = u_o & \quad \text{for all } Z \\ t = 0+ & \quad u = 0 & \quad \text{at } Z = 0 \text{ (top boundary)} \\ t = 0+ & \quad \partial u / \partial z = 0 & \quad \text{at } Z = H \text{ (bottom boundary)} \end{aligned}$$

Under the above boundary conditions the pore water pressure could be expressed as

$$u = \sum_{n=0}^{\infty} \left[\frac{2u_o}{M} \cdot \text{Sin} \frac{MZ}{H} \cdot e^{(-M^2 T_v)} \right]$$

Where $M = \frac{\pi}{2}(2n+1)$  University of Moratuwa, Sri Lanka.
 Electronic Theses & Dissertations
www.lib.mrt.ac.lk

and $T_v = \frac{C_v t}{H^2}$

The above expression is evaluated by adding up the values in the series till $n = 10$ and the variation of the pore water pressure u with time is estimated. This required the assumption of a value for the coefficient of consolidation C_v . A value of C_v is obtained by using the time taken for 50% consolidation settlement of the sample. The settlement at 100% excess pore water pressure dissipation was found and time required to 50% of that settlement was taken as t_{50} .

The settlement of the sample is related to the average degree of consolidation. If the average excess pore water pressure in the sample at time t is \bar{u} the average degree of consolidation is given by

$$U = \frac{\left(u_o - \bar{u} \right)}{u_o} = 1 - \frac{\bar{u}}{u_o} = 1 - \sum_{n=0}^{\infty} \frac{2}{M^2} e^{-M^2 T_v}$$

The settlement at time δ_t can be expressed as

$$U = \frac{\delta_t}{\delta}$$

Where δ is the ultimate settlement at 100% consolidation.

Therefore at a given time.

$$\delta_t = U\delta$$

7.4.2 Analysis of Test Data

It is necessary to compute the coefficient of consolidation C_v to back analyse the consolidation test data. Due to the difficulties in obtaining the C_v value for peat through conventional Casagrande's log time plot two other different approaches were used in this study. In the first approach the C_v value for the peat was estimated through the time taken for 50% of primary consolidation settlement. The primary consolidation settlement was the one corresponding for 100% pore water pressure dissipation. The coefficient of consolidation thus obtained was used in the expression for the pore water pressure and the variation of pore water pressure with time was computed. Taking the ultimate settlement (δ) to be the settlement at 100% pore water pressure dissipation, the δ_t values for different times were also computed using the relationship, $\delta_t = u\delta$.

The measured pore water pressure and the computed pore water pressures are compared for the untreated peat in Figure 53. The measured settlements and the computed settlements are compared for the untreated peat in Figure 54. Corresponding graphs for the peat mixed with 10% cement are presented in Figure 55 and Figure 56 respectively.

In the second approach the time for 50% pore water pressure dissipation at the base of the sample was taken from the laboratory test data. Using the standard isochrone corresponding to the 50% pore water pressure dissipation at the base, the time factor was obtained, and the coefficient of consolidation was estimated.

The measured pore water pressures are compared with the pore water pressures estimated using this method in Figure 53(a) for untreated peat. The measured settlements and

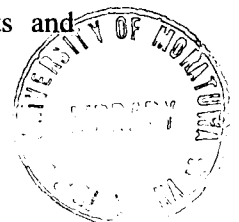

settlements estimated using this coefficient of consolidation are presented in Figure 54 (a), for the untreated peat.

Corresponding graphs for peat mixed with 10% cement are presented in Figures 55 (a) and 56 (a) respectively. The two methods of computation of C_v value and the corresponding tables are presented in the Appendix.

7.5 Application of Bjerrum Model Concepts for Peaty Clays

7.5.1 Bjerrum Model & Aging Curves

Bjerrum (1967) showed that the compressibility characteristic of a clay showing delayed consolidation cannot be described by a single curve in an e vs $\log \sigma$ plot. Instead, a series of lines corresponding to different times of sustained loading were used. (Figure 57). The volume change was separated into two components as “instant compression” and ‘delayed compression’.



University of Moratuwa, Sri Lanka.
Electronic Theses & Dissertations
www.lib.mrt.ac.lk

An “instant compression” is defined as “that occurs simultaneously with the increase in effective pressure and caused a reduction in void ratio until an equilibrium values was reached at which the structure effectively supported the overburden pressure. The delayed compression is defined as that representing the reduction in volume at unchanged effective stress”. (Bjerrum 1967). It was further said that “The two terms ‘instant’ and ‘delayed’ compression clearly describe the reaction of the clay with respect to an increase in the effective stress” Bjerrum (1967).

They are not exactly same as the terms “primary” and “secondary” compression. The subtle difference is illustrated in Figure 58.

Bjerrum (1967) explained that in the normally consolidated clay the shear strength would increase proportionally with the consolidation pressure. Therefore if the logarithm of the shear strength is plotted against the void ratio the points will fall on a straight line. This straight line will be parallel to the virgin consolidation line as depicted in Figure 57.

The compressibility characteristics of clay showing delayed consolidation are described by a series of lines in Figure 57. Each of these lines represents the equilibrium void ratio for different values of effective overburden pressure at a specific time of sustained loading. Consolidation tests have shown that the system of lines are approximately parallel. (Taylor 1942, Crawford 1965).

The reduction in water content during the “delayed consolidation” will clearly lead to a more stable configuration of the structure of clay. This means that during “delayed consolidation” a clay will develop increased strength and a reserve resistance against further compression. Such a clay can support an additional load in excess of the effective overburden pressure without any significant volume change (Bjerrum 1967).

The development of a reserve resistance against compression during delayed consolidation had been demonstrated in the laboratory. Bjerrum (1967) presented the data from a consolidation test done on a plastic clay sample taken from Drammen – Norway. The results are presented here in Figure 59.



University of Moratuwa, Sri Lanka.
Electronic Theses & Dissertations
www.lib.mrt.ac.lk

The clay sample was consolidated to 13 ton/m² and the load was applied for thirty days. Subsequently the sample was had developed a critical pressure p_c (maximum pre-consolidation pressure) which for the selected rate of loading amounted to 16 ton/m². This was 1.25 times the pressure at which the delayed consolidation took place. This series of curves were used by different researches to outline the undrained cohesion ΔC_u gained during consolidation. As shown in Figure 60 during the primary consolidation a gain correlating with the movement from B to C is achieved. As secondary consolidation is taking place a gain correlating with the movement from C to D is achieved.

These curves are also used to derive the reduction in the secondary consolidation settlements that can be achieved by the use of a surcharge i.e. a preload in excess of the final structural load.

As illustrated by Figure 61 the use of an additional surcharge load during the preloading will cause a reduction in void ratio up to point B. If a preload just equal to the final structural load is used the void ratio will reduce only up to point A.



In the latter case once the structural loads are applied a void ratio reduction from A to C could be observed over a 100 years design period. However, by the use of an additional surcharge during the preloading the void ratio can be reduced up to the value given by point B, and subsequent secondary consolidation settlement can be nullified.

As the usefulness of such a series of curves is realized a testing program was planned to obtain the said curves.

7.5.2 Experimental Procedure and results

Six-consolidation specimens were prepared from undisturbed samples obtained from the same location in the Madiwela Site. This was a difficult task due to the highly non-homogeneous nature of the peat. The specimen placed on the consolidation apparatus were subjected to stresses of 10 kN/m², 20 kN/m², 40 kN/m², 80 kN/m² and 160 kN/m² and the load was sustained for a period of 2 weeks. The void ratios at the end of 1 hr., 24 hr., 2 days etc., were plotted against the consolidation pressure as shown in Figure 62.



University of Moratuwa, Sri Lanka.
Electronic Theses & Dissertations
www.lib.mrt.ac.lk

Thereafter, the void ratios corresponding to the same time period were joined to obtain the set of curves corresponding to Bjerrum curves. These curves were approximately parallel to each other.

Further studies on this aspect could not be carried out due to the time limitations.

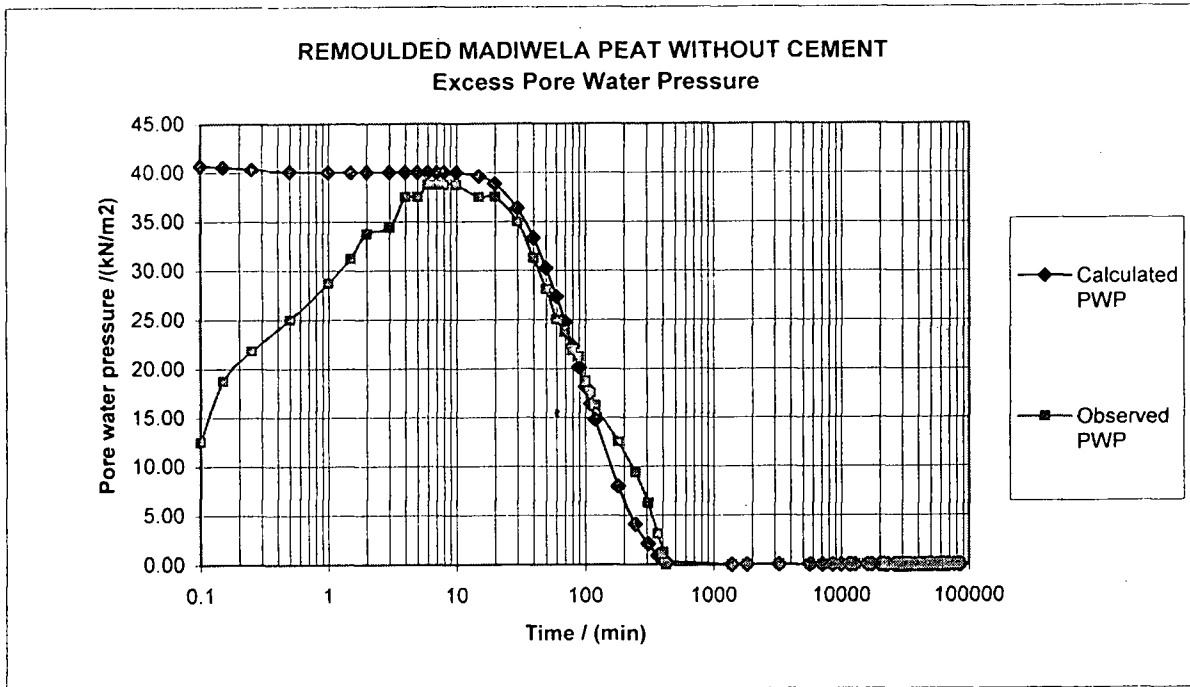

Figure 53: Comparison of Calculated and Observed Pore water pressure for Remoulded Madiwela Peat without cement



University of Moratuwa, Sri Lanka.
Electronic Theses & Dissertations
www.lib.mrt.ac.lk

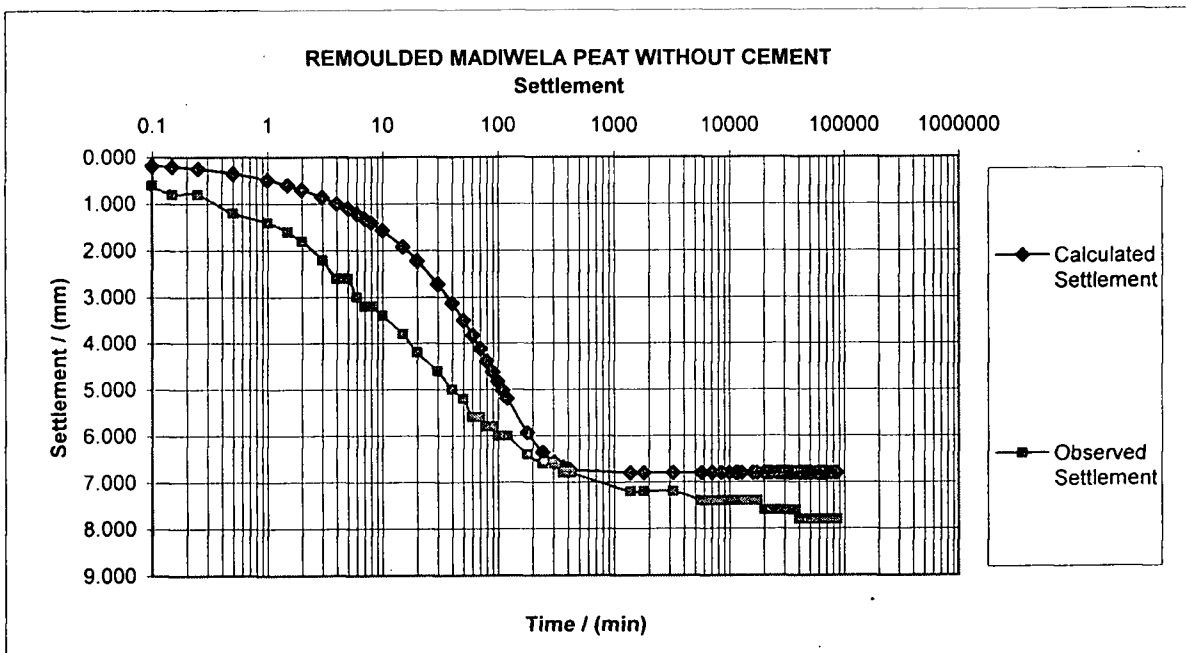

Figure 54: Comparison of Calculated and Observed Settlement for Remoulded Madiwela Peat without cement

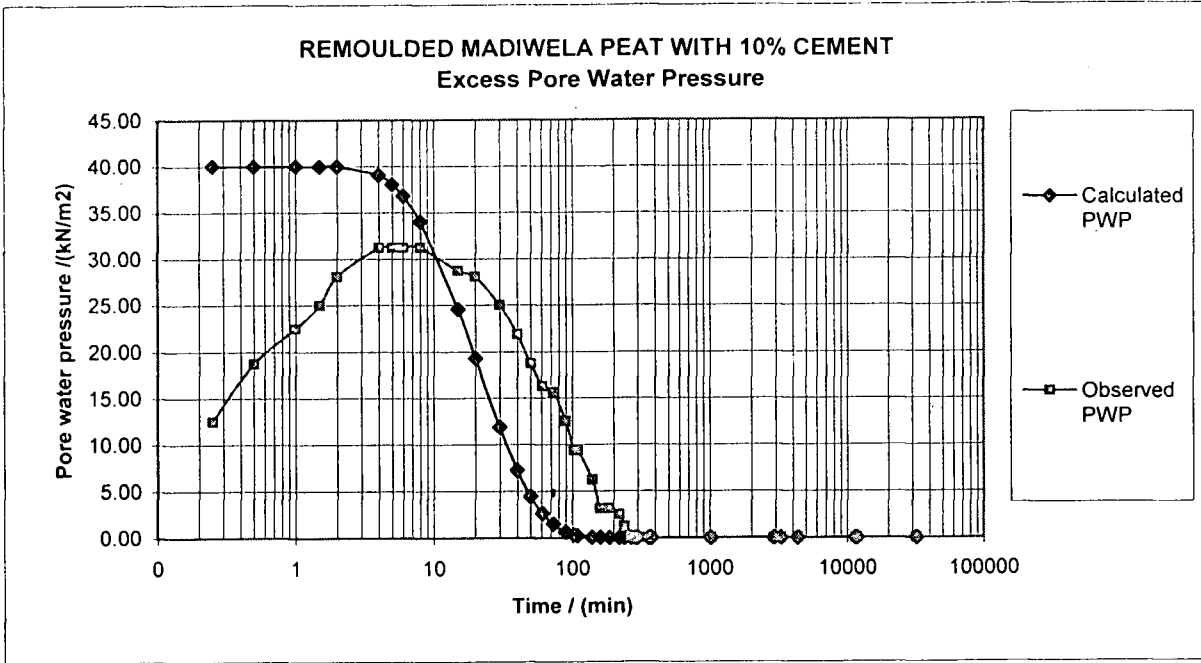

Figure 55: Comparison of Calculated and Observed Pore water pressure for Remoulded Madiwela Peat with 10% cement

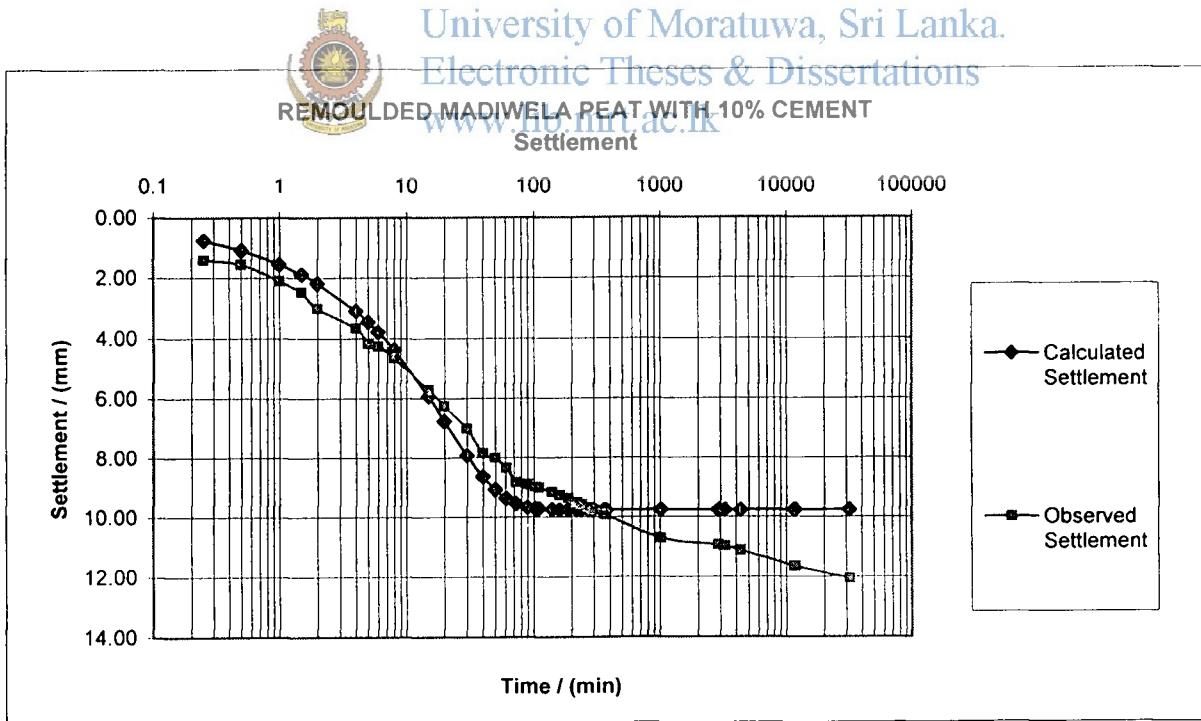

Figure 56: Comparison of Calculated and Observed Settlement for Remoulded Madiwela Peat with 10% cement

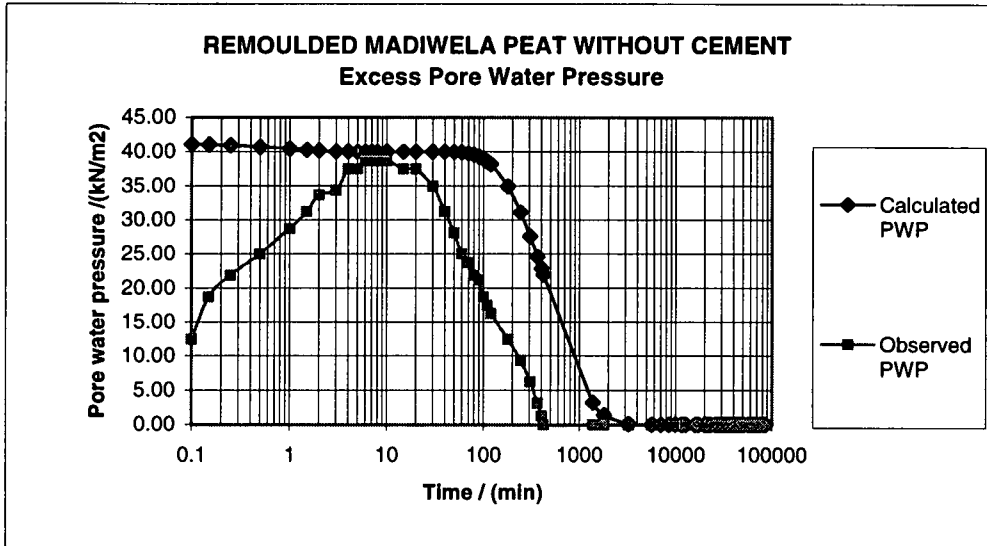

Figure 53(a): Comparison of Calculated and Observed Pore water pressure for Remoulded Madiwela Peat without cement

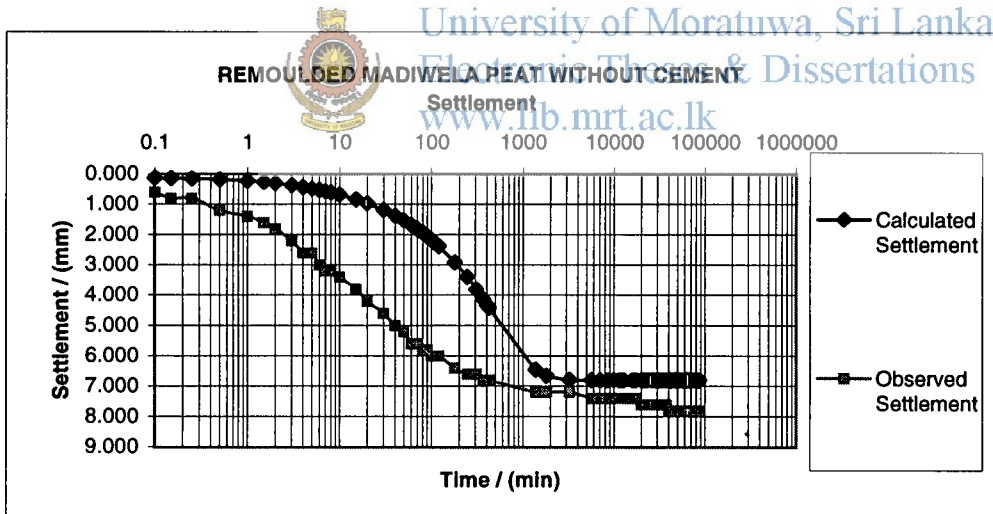

Figure 54(a): Comparison of Calculated and Observed Settlement for Remoulded Madiwela Peat without cement

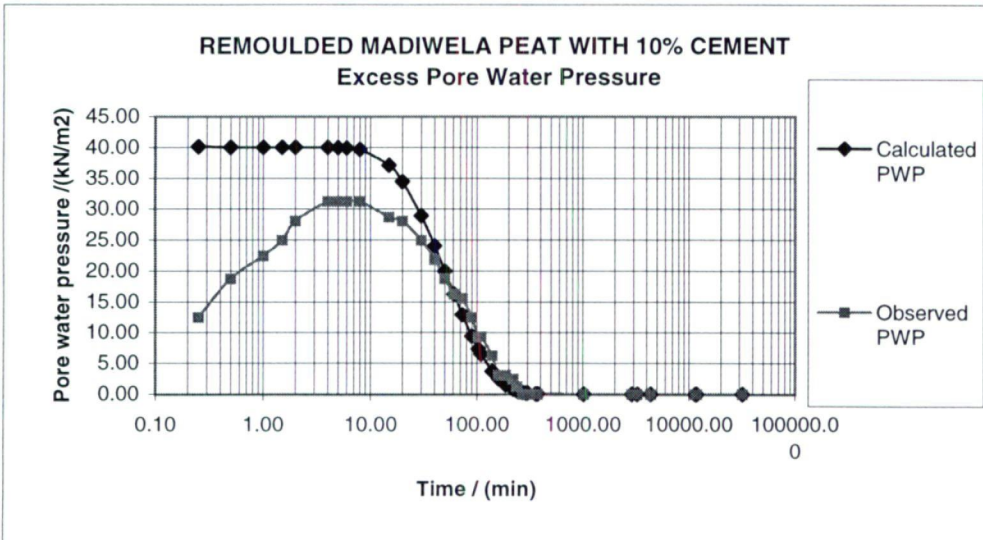

Figure 55(a): Comparison of Calculated and Observed Pore water pressure for Remoulded Madiwela Peat with 10% cement

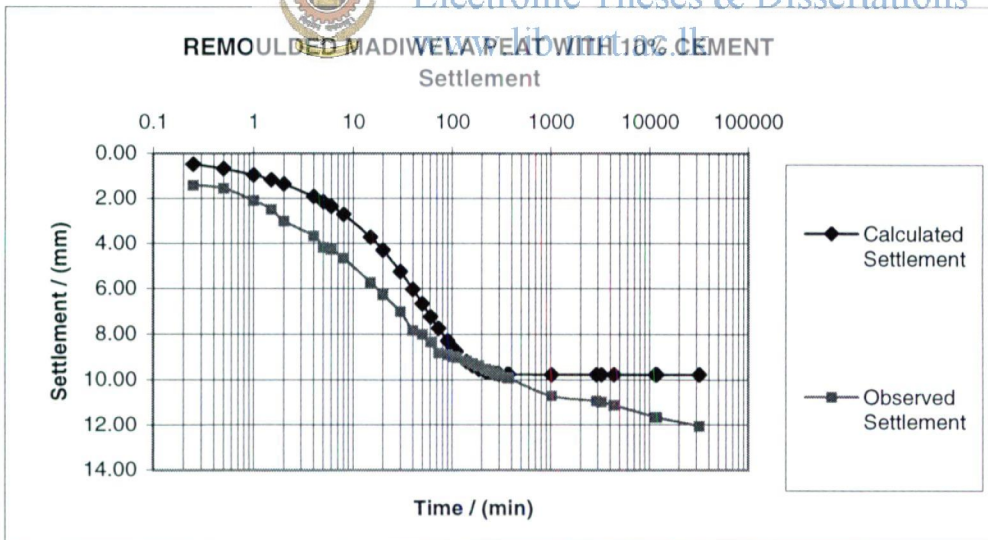

Figure 56(a): Comparison of Calculated and Observed Settlement for Remoulded Madiwela Peat with 10% cement



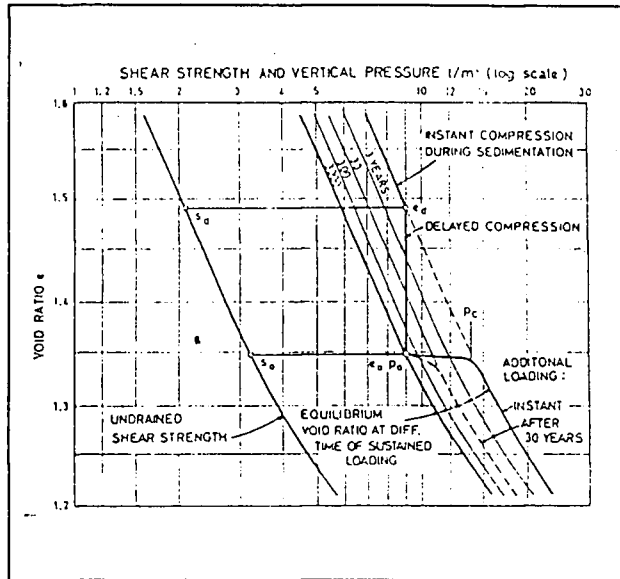

Figure 57: Compressibility and shear strength of a clay exhibiting delayed consolidation (after Bjerrum (1967))



University of Moratuwa, Sri Lanka.
Electronic Theses & Dissertations
www.lib.mrt.ac.lk

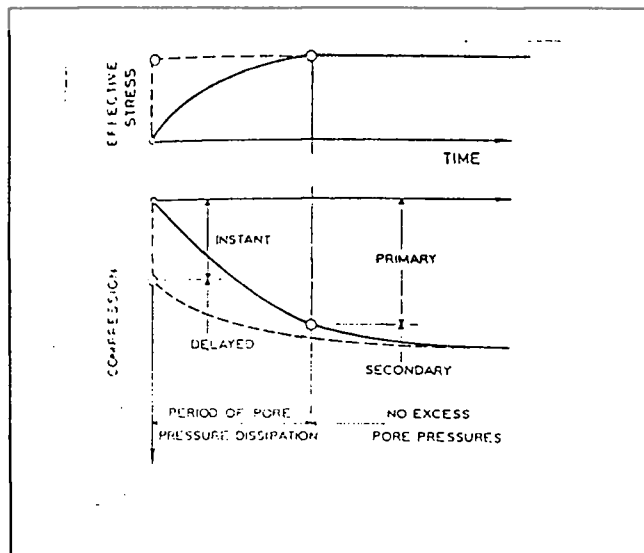

Figure 58: Definition of 'instant' and 'delayed' compression compared with 'primary' and 'secondary' compression (after Bjerrum (1967))

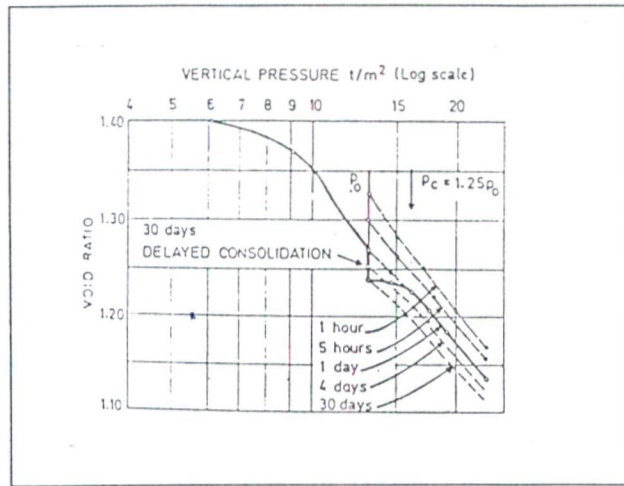

Figure 59: Results obtained with laboratory test on the plastic clay in Drammen (after Bjerrum (1967))

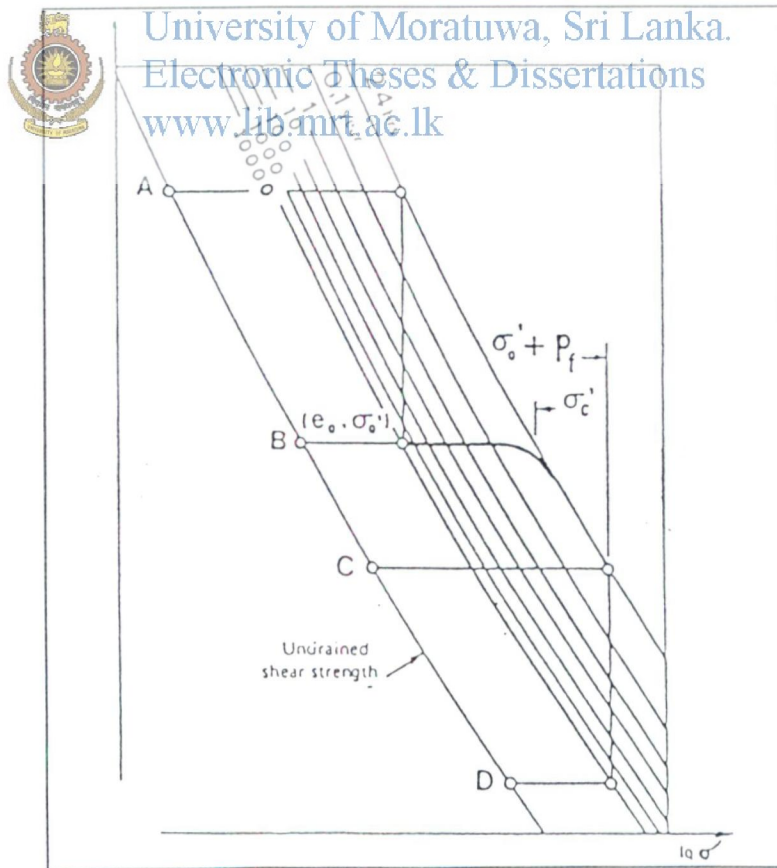

Figure 60: Evaluation of undrained cohesion gain (after Pilet et al (1976))



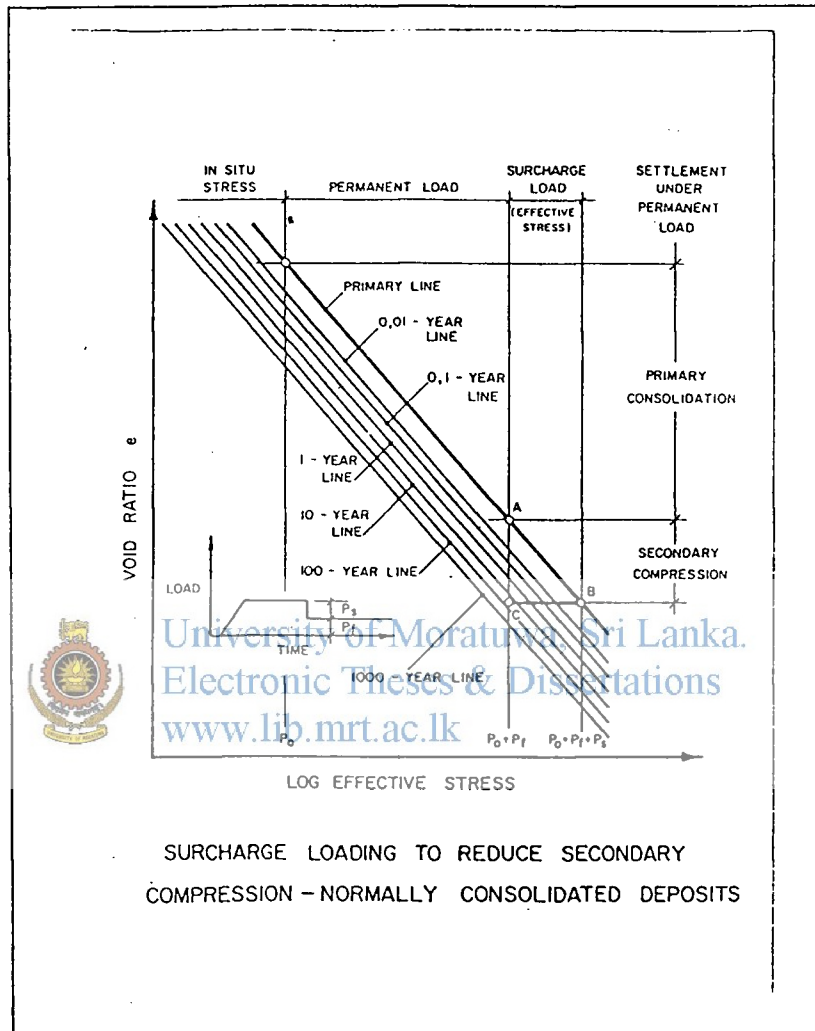

Figure 61: Surcharge Loading to reduce secondary compression
 – Normally Consolidated Deposits
 (after Davies P. (1980))

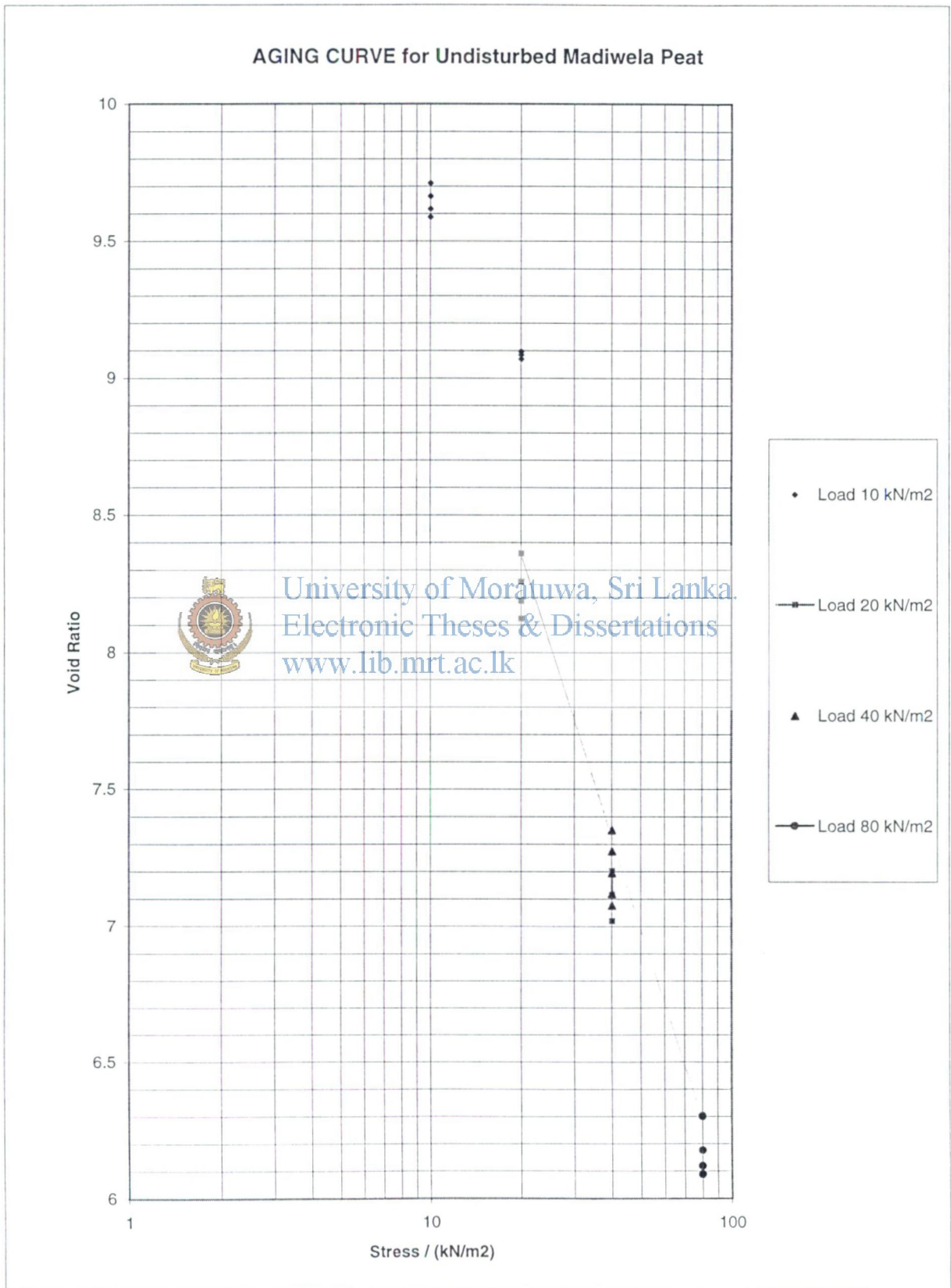
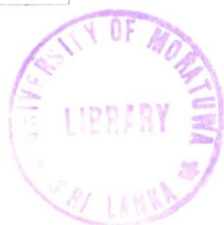

FIGURE 62 : BJERRUM CURVE OBTAINED FOR MADIWELA PEAT



CHATER 8

Conclusions

Improvement of thick deposits of soft peaty clays is one of the major challenges faced by the Sri Lankan Geotechnical Engineers. Three different methods of improvement; preloading, mixing with cement and mixing with lime were tried under laboratory conditions and improvements achieved in consolidation characteristics and shear strength properties were evaluated.

Preloading is seen to cause significant improvements in both primary and secondary consolidation properties on all types of peat that are at different levels of humification. Deep mixing with cement or lime has the advantage of being able to develop the strength and stiffness within a period as short as four weeks. However, this method is found to be successful only in the case of amorphous peats that are with a high level of humification. In such peats the level of improvement achieved in primary and secondary consolidation characteristics were of the same order as that achieved during preloading.



University of Moratuwa, Sri Lanka.
Electronic Theses & Dissertations
www.lib.mrt.ac.lk

Nevertheless, much greater levels of improvement were reported in literature for consolidation characteristics in inorganic soils due to cement/lime mixing.

The improvement of undrained shear strength ΔC_u could be expressed by , $\Delta C_u = \alpha \Delta \sigma$ where $\Delta \sigma$ is the increase in consolidation pressure. The value of α for Sri Lankan peat was around 0.2.

Some improvements were achieved in shear strength due to lime and cement mixing. The achieved improvement increased over a curing period from 2 weeks to 4 weeks. However, the achieved improvements were much smaller than that achieved with inorganic soils reported in literature.

Consolidation tests conducted with pore water pressure measurements revealed much information about the consolidation mechanism of peat. Due to the time limitations only some basic studies could be done. It is recommend here that further tests should be conducted and further attempts should be made to model the consolidation behaviour of peat with models other than Terzaghi. Also it is important to improve the response time of the pore water pressure measuring system.

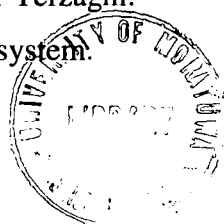

9. References

1. Barden, L. (1965a). - Consolidation of compacted and unsaturated clay. *Geotechnique* vol.15, 267-286.
2. Barden, L. (1968). - Primary and secondary consolidation of clays and peat. *Geotechnique* vol.18, 1-24.
3. Barden, L. (1969). - Time dependent deformation of normally consolidated clays and peats. *Journal of Soil Mechanics and Foundation Division, ASCE*, Sept. 1965, SM5, 15-35.
4. Bjerrum L. (1967) - Engineering Geology of Norwegian normally consolidated marine clays as related to settlements of buildings. *Geotechnique* vol.22, No.2, 81-118.
5. Brookes, A.H., West G., Carder, D.R - (1998) - Laboratory trial mixes for lime - stabilized soil columns and lime piles - TRL Report 306.
6. Crawford C.B., (1965), - Resistance of soil structures to consolidation. *Canadian Geotechnical Journal*. Pp. 90 - 115.
7. Davies P. (1980) - Notes on Improvement of Founding Conditions by the use of Preloading Techniques - D.L. Webb and Associates.
8. Garlanger, J.E. (1972). - The consolidation of soils exhibiting creep under constant effective stress. *Geotechnique* vol.22, No.1, 71-78.
9. Gibson, R.E. and Lo, K.Y. (1961). - A theory of consolidation of soils exhibiting secondary compression. N.G.I. Publication No. 41.



10. Hobbs, N.B., (1986) - Mire morphology and the properties and behaviour of some British and foreign peats quarterly. *Journal of Engineering Geology*, 19 Vol. 1, 7 – 80.
11. Hobbs, N.B., (1987) - A note on the classification of peat - *Geotechnique* 37, No. 3, pp. 405 – 407.
12. Huttunen, E., Kujala, K., and Vesa, H., (1996) - Assessment of the quality of stabilized peat and clay. *Proceeding of the International Symposium on Grouting and Deep Mixing (in Japan)*.
13. Kulathilake S.A.S. (1999). – Improvement of Engineering Properties of Peat by Preconsolidation – 11th Asian Regional Conference on Soil Mechanics and Geotechnical Engineering at Seoul, South Korea.
14. Lo K.W., Ooi P. L., Lee S.L. Unified approach for ground improvement by Heavy Tamping. *ASCE Journal of Geotechnical Engineering* pp 63-76. vol 116 No 3 March 1990
15. Mesri G., Stark T.D., Ajlouni M.A., Chen C.S., Secondary Compression of Peat with or without Surcharging. *Journal of Geotechnical and Geoenvironmental Engineering*. Vol No 5 May 1997.
16. Pilot G. Chaput D. Queyroi D., Improvement of soft clay – Usual methods. Chapter 5 – Embankments on soft clays. Ellis Horward Co. Ltd.
17. Priyankara N.H., Priyantha N.N.A., Nilanthi K.H.B. (2000), Comparison of Methods of Improvements of Compressibility Properties of Peat. Final Year Project Report, Department of Civil Engineering, University of Moratuwa.

18. Porbaha, H. (1998) - State of the art in deep mixing technology : Part I Basic concepts and overview. pp. 81-92. Ground Improvement Journal. Thomas Telford Ltd.
19. Probaha, A., Tanaka, H., and Kobayashi, M., (1998) - State of art in deep mixing technology : Part II applications. pp. 125 – 139. Ground Improvement Journal. Thomas Telford Ltd.
20. Rowe, P.W., and Barden, L. (1996)- A new consolidation cell- Geotechnique Vol.16 No. 2 pp. 162 – 170.
21. Taylor. D.W., (1942), Research on consolidation of clays. Massachusetts Institute of Technology Department of Civil and Sanitary Engineering, Serial 82 147 pp.
22. Terzaghi. K. (1925) – Erdbaumechanik auf bodenphysikalischer Grunlage.Leipzig: Deuticke.
23. Von Post, L. (1922) - Sveriges Geologiska Undersokings - Torvinventering och nogra av dess hittills vunna resultat (SGU Peat inventory and some preliminary results) Svenka Moss kulturfor, Tidski, 36, pp. 1 – 37.

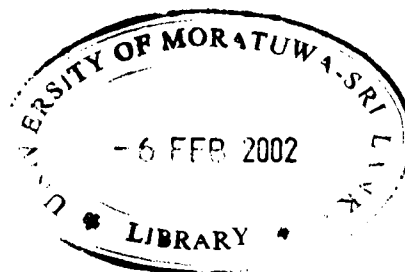



APPENDIX
University of Moratuwa, Sri Lanka.
Electronic Theses & Dissertations
www.lib.mrt.ac.lk

Calculation of Pore Water Pressure using Terzaghi's Model
Remoulded Madiwela Peat with 10% cement with pore pressure measurement

$H_{dr} =$	61.2 mm	$U_o =$	40 kN/m ²
$C_v =$	73.83 mm ² /min	$Z =$	61.22 mm

M = (π/2)*(2m+1)						Sin (M* Z/Hdr)						2Uo/M						Sin (M* Z/Hdr) * 2Uo/M					
m = 0	m = 1	m = 2	m = 3	m = 4	m = 5	m = 0	m = 1	m = 2	m = 3	m = 4	m = 5	m = 0	m = 1	m = 2	m = 3	m = 4	m = 5	m = 0	m = 1	m = 2	m = 3	m = 4	m = 5
1.57	4.71	7.85	10.99	14.13	17.27	1	-1	1	-1	1	-1	50.955	16.985	10.191	7.279	5.662	4.632	50.96	-16.99	10.19	-7.28	5.66	-4.63
m = 6	m = 7	m = 8	m = 9	m = 10	m = 11	m = 6	m = 7	m = 8	m = 9	m = 10	m = 11	m = 6	m = 7	m = 8	m = 9	m = 10	m = 11	m = 6	m = 7	m = 8	m = 9	m = 10	m = 11
20.41	23.55	26.69	29.83	32.97	36.11	1	-1	1	-1	1	-1	3.920	3.397	2.997	2.682	2.426	2.215	3.92	-3.40	3.00	-2.68	2.43	-2.22

t	δ	C _v	T _v	e ^(-M²*Tv)											(Sin (M* Z/Hdr) * 2Uo/M)*(e ^(-M²*Tv))										SUM-U	measure d U		
				m = 0	m = 1	m = 2	m = 3	m = 4	m = 5	m = 6	m = 7	m = 8	m = 9	m = 10	m = 0	m = 1	m = 2	m = 3	m = 4	m = 5	m = 6	m = 7	m = 8	m = 9			m = 10	
0	0.00	73.83	0	1	1	1	1	1	1	1	1	1	1	1	50.955	-2E+01	10.191	-7.279	5.662	-4.632	3.919	-3.397	2.997	-3E+00	2.426	41.176	9.375	
0.25	1.41	73.83	0.005	0.988	0.897	0.738	0.552	0.374	0.23	0.129	0.065	0.03	0.012	0.005	50.341	-2E+01	7.523	-4.016	2.118	-1.066	0.504	-0.221	0.090	-3E-02	0.011	40.023	12.500	
0.50	1.55	73.83	0.01	0.976	0.804	0.545	0.304	0.14	0.053	0.017	0.004	9E-04	2E-04	2E-05	49.733	-1E+01	5.554	-2.215	0.792	-0.245	0.065	-0.014	0.003	-4E-04	0.000	40.020	18.750	
1.00	2.09	73.83	0.02	0.953	0.646	0.297	0.093	0.02	0.003	3E-04	2E-05	8E-07	2E-08	5E-10	48.540	-1E+01	3.027	-0.674	0.111	-0.013	0.001	0.000	0.000	-7E-08	0.000	40.020	22.500	
1.50	2.47	73.83	0.03	0.93	0.519	0.162	0.028	0.003	1E-04	5E-06	8E-08	7E-10	4E-12	1E-14	47.376	-9E+00	1.650	-0.205	0.016	-0.001	2E-05	0.000	0.000	-1E-11	0.000	40.017	25.000	
2.00	3.00	73.83	0.039	0.907	0.417	0.088	0.009	4E-04	8E-06	7E-08	8E-10	6E-13	6E-16	3E-19	46.239	-7E+00	0.899	-0.062	0.002	0.000	3E-07	0.000	0.000	-2E-15	0.000	39.991	28.125	
4.00	3.66	73.83	0.079	0.823	0.174	0.008	7E-05	1E-07	6E-11	6E-15	1E-19	4E-25	4E-31	6E-38	44.060	-3E+00	0.079	-0.001	8E-07	0.000	2E-14	0.000	0.000	-9E-31	0.000	39.082	31.250	
5.00	4.17	73.83	0.098	0.784	0.112	0.002	7E-06	3E-09	2E-13	2E-18	2E-24	3E-31	9E-39	3E-47	39.971	-2E+00	0.024	0.000	2E-08	0.000	6E-18	0.000	0.000	-2E-38	0.000	38.084	31.250	
6.00	4.26	73.83	0.118	0.747	0.073	7E-04	6E-07	6E-11	5E-16	4E-22	3E-29	3E-37	2E-46	2E-56	38.077	-1E+00	0.007	0.000	3E-10	0.000	2E-21	0.000	0.000	-6E-46	0.000	36.850	31.250	
8.00	4.65	73.83	0.158	0.678	0.03	6E-05	5E-09	2E-14	4E-21	3E-29	1E-38	2E-49	1E-61	4E-75	34.553	-5E-01	0.001	0.000	1E-13	0.000	1E-28	0.000	0.000	-3E-61	0.000	34.038	31.250	
15.00	5.72	73.83	0.295	0.483	0.001	1E-08	3E-16	2E-26	5E-39	3E-54	7E-72	4E-92	#####	#####	24.596	-2E-02	0.000	0.000	1E-25	0.000	1E-53	0.000	0.000	-2E-114	0.000	24.572	28.750	
20.00	6.26	73.83	0.394	0.379	2E-04	3E-11	2E-21	7E-35	9E-52	5E-72	1E-95	#####	#####	#####	19.294	-3E-03	0.000	0.000	4E-34	0.000	2E-71	0.000	0.000	-1E-152	0.000	19.291	28.125	
30.00	7.01	73.83	0.591	0.233	2E-06	2E-16	1E-31	6E-52	3E-77	#####	#####	#####	#####	#####	11.872	-3E-05	0.000	0.000	3E-51	0.000	#####	0.000	0.000	-1E-228	0.000	11.872	25.000	
40.00	7.83	73.83	0.788	0.143	3E-08	8E-22	5E-42	5E-69	#####	#####	#####	#####	#####	0	7.305	-4E-07	0.000	0.000	3E-68	0.000	#####	0.000	0.000	-8E-305	0.000	7.305	21.875	
50.00	8.00	73.83	0.985	0.088	3E-10	4E-27	2E-52	4E-86	#####	#####	#####	#####	0	0	4.495	-5E-09	0.000	0.000	2E-85	0.000	#####	0.000	0.000	0E+00	0.000	4.495	18.750	
61.00	8.34	73.83	1.202	0.052	3E-12	7E-33	9E-64	#####	#####	#####	#####	#####	0	0	2.635	-4E-11	0.000	0.000	#####	0.000	#####	0.000	0.000	0E+00	0.000	2.635	16.250	
73.00	8.82	73.83	1.438	0.029	1E-14	3E-39	4E-76	#####	#####	#####	#####	#####	0	0	1.471	-2E-13	0.000	0.000	#####	0.000	#####	0.000	0.000	0E+00	0.000	1.471	15.625	
90.00	8.89	73.83	1.773	0.013	8E-18	4E-48	1E-93	#####	#####	#####	#####	#####	0	0	0.644	-1E-16	0.000	0.000	#####	0.000	#####	0.000	0.000	0E+00	0.000	0.644	12.500	
103.00	8.98	73.83	2.029	0.007	3E-20	5E-55	#####	#####	#####	#####	#####	#####	0	0	0.343	-5E-19	0.000	0.000	#####	0.000	#####	0.000	0.000	0E+00	0.000	0.343	9.375	
110.00	9.01	73.83	2.167	0.005	1E-21	1E-58	#####	#####	#####	#####	#####	#####	0	0	0.244	-2E-20	0.000	0.000	#####	0.000	#####	0.000	0.000	0E+00	0.000	0.244	9.375	
140.00	9.16	73.83	2.758	0.001	3E-27	2E-74	#####	#####	#####	#####	#####	#####	0	0	0.057	-5E-26	0.000	0.000	#####	0.000	#####	0.000	0.000	0E+00	0.000	0.057	6.250	
161.00	9.27	73.83	3.172	4E-04	3E-31	1E-85	#####	#####	#####	#####	#####	#####	0	0	0.021	-5E-30	0.000	0.000	#####	0.000	#####	0.000	0.000	0E+00	0.000	0.021	3.125	
187.00	9.37	73.83	3.684	1E-04	3E-36	3E-99	#####	#####	#####	#####	#####	#####	0	0	0.006	-5E-35	0.000	0.000	#####	0.000	#####	0.000	0.000	0E+00	0.000	0.006	3.125	
220.00	9.52	73.83	4.334	2E-05	2E-42	#####	#####	#####	#####	#####	#####	#####	0	0	0.001	-3E-41	0.000	0.000	#####	0.000	#####	0.000	0.000	0E+00	0.000	0.001	2.500	
240.00	9.58	73.83	4.728	9E-06	3E-46	#####	#####	#####	#####	#####	#####	#####	0	0	0.000	-5E-45	3E-126	0.000	0.000	#####	0.000	#####	0.000	0.000	0E+00	0.000	0.000	1.250
271.00	9.68	73.83	5.339	2E-06	4E-52	#####	#####	#####	#####	#####	#####	#####	0	0	0.000	-6E-51	1E-142	0.000	0.000	#####	0.000	#####	0.000	0.000	0E+00	0.000	0.000	0.000
290.00	9.77	73.83	5.713	8E-07	9E-56	#####	#####	#####	#####	#####	#####	#####	0	0	0.000	-2E-54	1E-152	0.000	0.000	#####	0.000	#####	0.000	0.000	0E+00	0.000	0.000	0.000
300.00	9.77	73.83	5.91	5E-07	1E-57	#####	#####	#####	#####	#####	#####	#####	0	0	0.000	-2E-56	7E-158	0.000	0.000	#####	0.000	#####	0.000	0.000	0E+00	0.000	0.000	0.000
360.00	9.89	73.83	7.092	3E-08	5E-69	#####	#####	#####	#####	#####	#####	#####	0	0	0.000	-8E-68	2E-189	0.000	0.000	#####	0.000	#####	0.000	0.000	0E+00	0.000	0.000	0.000
375.00	9.916	73.83	7.387	1E-08	7E-72	#####	#####	#####	#####	#####	#####	#####	0	0	0.000	-1E-70	2E-197	0.000	0.000	#####	0.000	#####	0.000	0.000	0E+00	0.000	0.000	0.000

Table 4

Calculation of Settlement using Terzaghi's Model
Remoulded Madiwela Peat with 10% cement with pore pressure measurement

$H_{dr} =$ 61.2 mm	$U_o =$ 40 kN/m ²	$\delta_i =$ 9.76 mm
$C_v =$ 73.83 mm ² /min	$Z =$ 61.22 mm	

$M = (\pi/2)^*(2m+1)$											
m = 0	m = 1	m = 2	m = 3	m = 4	m = 5	m = 6	m = 7	m = 8	m = 9	m = 10	m = 11
1.57	4.71	7.85	10.99	14.13	17.27	20.41	23.55	26.69	29.83	32.97	36.11

t	measu red δ	C_v	T_v	$e^{(-M^2 \cdot T_v)}$											$(2 / M^2) \cdot (e^{(-M^2 \cdot T_v)}) \cdot \dots (A)$										SUM of (A)	U-T- Sum (A)	$\delta = \delta_i \cdot U$		
				m=0	m=1	m=2	m=3	m=4	m=5	m=6	m=7	m=8	m=9	m=10	m=0	m=1	m=2	m=3	m=4	m=5	m=6	m=7	m=8	m=9				m=10	
0	0.00	73.83	0	1	1	1	1	1	1	1	1	1	1	1	1	0.811	0.090	0.032	0.017	0.010	0.007	0.005	0.004	0.003	0.002	0.002	0.983	0.017	0.170
0.25	1.41	73.83	0.005	0.988	0.897	0.738	0.552	0.374	0.23	0.129	0.065	0.03	0.012	0.005	0.802	0.081	0.024	0.009	0.004	0.002	0.001	0.000	0.000	0.000	0.000	0.922	0.078	0.763	
0.50	1.55	73.83	0.01	0.976	0.804	0.545	0.304	0.14	0.053	0.017	0.004	9E-04	2E-04	2E-05	0.792	0.072	0.018	0.005	0.001	0.000	0.000	0.000	0.000	0.000	0.000	0.889	0.111	1.084	
1.00	2.09	73.83	0.02	0.953	0.646	0.297	0.093	0.02	0.003	3E-04	2E-05	8E-07	2E-08	5E-10	0.773	0.058	0.016	0.002	0.000	0.000	0.000	0.000	0.000	0.000	0.000	0.843	0.157	1.537	
1.50	2.47	73.83	0.03	0.93	0.519	0.162	0.028	0.003	1E-04	5E-06	8E-08	7E-10	4E-12	1E-14	0.754	0.047	0.005	0.000	0.000	0.000	0.000	0.000	0.000	0.000	0.000	0.807	0.193	1.884	
2.0	3.00	73.83	0.039	0.907	0.417	0.088	0.009	4E-04	8E-06	7E-06	3E-10	6E-13	6E-16	3E-19	0.736	0.038	0.003	0.000	0.000	0.000	0.000	0.000	0.000	0.000	0.000	0.777	0.223	2.177	
4.0	3.66	73.83	0.079	0.823	0.174	0.008	7E-05	1E-07	6E-11	6E-15	1E-19	4E-25	4E-31	6E-38	0.668	0.016	0.000	0.000	0.000	0.000	0.000	0.000	0.000	0.000	0.000	0.684	0.316	3.083	
5.0	4.17	73.83	0.098	0.784	0.112	0.002	7E-06	3E-09	2E-13	2E-18	2E-24	3E-31	9E-39	3E-47	0.636	0.010	0.000	0.000	0.000	0.000	0.000	0.000	0.000	0.000	0.000	0.647	0.353	3.448	
6.0	4.26	73.83	0.118	0.747	0.073	7E-04	6E-07	6E-11	5E-16	4E-22	3E-29	3E-37	2E-46	2E-56	0.606	0.007	0.000	0.000	0.000	0.000	0.000	0.000	0.000	0.000	0.000	0.613	0.387	3.778	
8.0	4.65	73.83	0.158	0.678	0.03	6E-05	5E-09	2E-14	4E-21	3E-29	1E-38	2E-49	1E-61	4E-75	0.550	0.003	0.000	0.000	0.000	0.000	0.000	0.000	0.000	0.000	0.000	0.553	0.447	4.363	
15.0	5.72	73.83	0.295	0.483	0.001	1E-08	3E-16	2E-26	5E-39	3E-54	7E-72	4E-92	#####	#####	0.392	0.000	0.000	0.000	0.000	0.000	0.000	0.000	0.000	0.000	0.000	0.392	0.608	5.936	
20.0	6.26	73.83	0.394	0.379	2E-04	3E-11	2E-21	7E-35	9E-52	5E-72	1E-95	#####	#####	#####	0.307	0.000	0.000	0.000	0.000	0.000	0.000	0.000	0.000	0.000	0.000	0.307	0.693	6.761	
30.0	7.01	73.83	0.591	0.233	2E-06	2E-16	1E-31	6E-52	3E-77	#####	#####	#####	#####	#####	0.189	0.000	0.000	0.000	0.000	0.000	0.000	0.000	0.000	0.000	0.000	0.189	0.811	7.915	
40.0	7.83	73.83	0.788	0.143	3E-08	8E-22	5E-42	5E-69	#####	#####	#####	#####	#####	#####	0	0.116	0.000	0.000	0.000	0.000	0.000	0.000	0.000	0.000	0.000	0.000	0.116	0.884	8.625
50.0	8.00	73.83	0.985	0.088	3E-10	4E-27	2E-52	4E-86	#####	#####	#####	#####	#####	#####	0	0	0.072	0.000	0.000	0.000	0.000	0.000	0.000	0.000	0.000	0.000	0.072	0.928	9.061
61.0	8.34	73.83	1.202	0.052	3E-12	7E-33	9E-64	#####	#####	#####	#####	#####	#####	#####	0	0	0.042	0.000	0.000	0.000	0.000	0.000	0.000	0.000	0.000	0.000	0.042	0.958	9.350
73.0	8.82	73.83	1.438	0.029	1E-14	3E-39	4E-76	#####	#####	#####	#####	#####	#####	#####	0	0	0.023	0.000	0.000	0.000	0.000	0.000	0.000	0.000	0.000	0.000	0.023	0.977	9.531
90.0	8.89	73.83	1.773	0.013	8E-18	4E-48	1E-93	#####	#####	#####	#####	#####	#####	#####	0	0	0.010	0.000	0.000	0.000	0.000	0.000	0.000	0.000	0.000	0.000	0.010	0.990	9.660
103.0	8.98	73.83	2.029	0.007	3E-20	5E-55	#####	#####	#####	#####	#####	#####	#####	#####	0	0	0.005	0.000	0.000	0.000	0.000	0.000	0.000	0.000	0.000	0.000	0.005	0.995	9.707
110.0	9.01	73.83	2.167	0.005	1E-21	1E-58	#####	#####	#####	#####	#####	#####	#####	#####	0	0	0.004	0.000	0.000	0.000	0.000	0.000	0.000	0.000	0.000	0.000	0.004	0.996	9.722
140.0	9.16	73.83	2.758	0.001	3E-27	2E-74	#####	#####	#####	#####	#####	#####	#####	#####	0	0	0.001	0.000	0.000	0.000	0.000	0.000	0.000	0.000	0.000	0.000	0.001	0.999	9.751
161.0	9.27	73.83	3.172	4E-04	3E-31	1E-85	#####	#####	#####	#####	#####	#####	#####	#####	0	0	0.000	0.000	0.000	0.000	0.000	0.000	0.000	0.000	0.000	0.000	0.000	1.000	9.757
187.0	9.37	73.83	3.684	1E-04	3E-36	3E-99	#####	#####	#####	#####	#####	#####	#####	#####	0	0	0.000	0.000	0.000	0.000	0.000	0.000	0.000	0.000	0.000	0.000	0.000	1.000	9.759
220.0	9.52	73.83	4.334	2E-05	2E-42	#####	#####	#####	#####	#####	#####	#####	#####	#####	0	0	0.000	0.000	0.000	0.000	0.000	0.000	0.000	0.000	0.000	0.000	0.000	1.000	9.760
240.0	9.58	73.83	4.728	9E-06	3E-46	#####	#####	#####	#####	#####	#####	#####	#####	#####	0	0	0.000	0.000	0.000	0.000	0.000	0.000	0.000	0.000	0.000	0.000	0.000	1.000	9.760
271.0	9.68	73.83	5.339	2E-06	4E-52	#####	#####	#####	#####	#####	#####	#####	#####	#####	0	0	0.000	0.000	0.000	0.000	0.000	0.000	0.000	0.000	0.000	0.000	0.000	1.000	9.760
290.0	9.77	73.83	5.713	8E-07	9E-56	#####	#####	#####	#####	#####	#####	#####	#####	#####	0	0	0.000	0.000	0.000	0.000	0.000	0.000	0.000	0.000	0.000	0.000	0.000	1.000	9.760
300.0	9.77	73.83	5.91	5E-07	1E-57	#####	#####	#####	#####	#####	#####	#####	#####	#####	0	0	0.000	0.000	0.000	0.000	0.000	0.000	0.000	0.000	0.000	0.000	0.000	1.000	9.760
360.0	9.89	73.83	7.092	3E-08	5E-69	#####	#####	#####	#####	#####	#####	#####	#####	#####	0	0	0.000	0.000	0.000	0.000	0.000	0.000	0.000	0.000	0.000	0.000	0.000	1.000	9.760
375.0	9.916	73.83	7.387	1E-08	7E-72	#####	#####	#####	#####	#####	#####	#####	#####	#####	0	0	0.000	0.000	0.000	0.000	0.000	0.000	0.000	0.000	0.000	0.000	0.000	1.000	9.760

Table 5

Calculation of Pore Water Pressure using Terzaghi's Model
Remoulded Madiwela Peat without cement with pore pressure measurement

$H_{dr} =$	28.2 mm	$U_o =$	40 kN/m ²
$C_v =$	15.67 mm ² /min	$Z =$	28.18 mm

$M = (\pi/2) * (2m+1)$						$\sin(M * Z/Hdr)$						$2U_o/M$					$\sin(M * Z/Hdr) * 2U_o/M$						
m=0	m=1	m=2	m=3	m=4	m=5	m=0	m=1	m=2	m=3	m=4	m=5	m=0	m=1	m=2	m=3	m=4	m=5	m=0	m=1	m=2	m=3	m=4	m=5
1.57	4.71	7.85	10.99	14.13	17.27	1	-1	1	-1	1	-1	50.955	16.985	10.191	7.279	5.662	4.632	50.96	-16.99	10.19	-7.28	5.66	-4.63
m=6	m=7	m=8	m=9	m=10	m=11	m=6	m=7	m=8	m=9	m=10	m=11	m=6	m=7	m=8	m=9	m=10	m=11	m=6	m=7	m=8	m=9	m=10	m=11
20.41	23.55	26.69	29.83	32.97	36.11	1	-1	1	-1	1	-1	3.920	3.397	2.997	2.682	2.426	2.215	3.92	-3.40	3.00	-2.68	2.43	-2.22

t	δ	C_v	T_v	$e^{-M^2 * Tv}$											$(\sin(M * Z/Hdr) * 2U_o/M) * e^{-M^2 * Tv}$										SUM=U	measure d U	
				m=0	m=1	m=2	m=3	m=4	m=5	m=6	m=7	m=8	m=9	m=10	m=0	m=1	m=2	m=3	m=4	m=5	m=6	m=7	m=8	m=9			m=10
0	0.00	15.67	0	1	1	1	1	1	1	1	1	1	1	50.955	-2E+01	10.191	-7.279	5.662	-4.632	3.919	-3.397	2.997	-3E+00	2.426	41.176	9.38	
0.10	0.60	15.67	4E-04	0.999	0.991	0.975	0.951	0.92	0.883	0.84	0.793	0.742	0.689	0.635	50.903	-2E+01	9.932	-6.921	5.208	-4.089	3.293	-2.694	2.225	-2E+00	1.540	40.721	12.50
0.15	0.80	15.67	6E-04	0.998	0.986	0.962	0.927	0.882	0.829	0.77	0.706	0.64	0.572	0.506	50.877	-2E+01	9.805	-6.748	4.995	-3.842	3.018	-2.399	1.917	-2E+00	1.227	40.565	18.75
0.25	0.80	15.67	0.001	0.997	0.977	0.938	0.881	0.812	0.732	0.647	0.56	0.475	0.395	0.321	50.824	-2E+01	9.555	-6.416	4.595	-3.391	2.536	-1.902	1.423	-1E+00	0.779	40.349	21.88
0.50	1.20	15.67	0.002	0.995	0.955	0.879	0.777	0.659	0.536	0.419	0.314	0.226	0.156	0.103	50.694	-2E+01	8.959	-5.655	3.73	-2.483	1.641	-1.065	0.676	-4E-01	0.250	40.113	25.00
1.00	1.40	15.67	0.004	0.99	0.911	0.773	0.604	0.434	0.287	0.175	0.098	0.051	0.024	0.011	50.433	-2E+01	7.876	-4.393	2.457	-1.331	0.687	-0.334	0.152	-6E-02	0.026	40.027	28.75
1.50	1.60	15.67	0.006	0.985	0.87	0.679	0.469	0.286	0.154	0.073	0.031	0.011	0.004	0.001	50.174	-1E+01	6.924	-3.413	1.619	-0.714	0.287	-0.105	0.034	-1E-02	0.003	40.021	31.25
2.00	1.80	15.67	0.008	0.98	0.831	0.597	0.364	0.188	0.083	0.031	0.01	0.003	6E-04	1E-04	49.916	-1E+01	6.087	-2.651	1.066	-0.383	0.12	-0.033	0.008	-2E-03	0.000	40.020	33.75
3.00	2.20	15.67	0.013	0.97	0.757	0.462	0.22	0.082	0.024	0.005	0.003	1E-03	1E-04	49.404	-1E+01	4.705	-1.600	0.463	-0.099	0.021	-0.003	0.000	0.000	-4E-05	0.000	40.020	34.38
4.00	2.60	15.67	0.017	0.96	0.69	0.357	0.133	0.035	0.007	9E-04	9E-05	7E-06	3E-07	1E-08	48.898	-1E+01	3.636	-0.966	0.201	-0.032	0.004	0.000	0.000	-9E-07	0.000	40.020	37.50
5.00	2.60	15.67	0.021	0.95	0.629	0.276	0.08	0.015	0.002	2E-04	9E-06	3E-07	8E-09	1E-10	48.396	-1E+01	2.811	-0.583	0.087	-0.009	6E-04	0.000	0.000	-2E-08	0.000	40.020	37.50
6.00	3.00	15.67	0.025	0.94	0.573	0.213	0.048	0.007	6E-04	3E-05	9E-07	2E-08	2E-10	1E-12	47.900	-1E+01	2.172	-0.352	0.038	-0.003	1E-04	0.000	0.000	-5E-10	0.000	40.020	38.75
7.00	3.20	15.67	0.029	0.93	0.522	0.165	0.029	0.003	2E-04	5E-06	9E-08	9E-10	5E-12	2E-14	47.409	-9E+00	1.679	-0.212	0.016	-0.001	2E-05	0.000	0.000	-1E-11	0.000	40.017	38.75
8.00	3.20	15.67	0.033	0.921	0.476	0.127	0.018	0.001	5E-05	9E-07	9E-09	4E-11	1E-13	2E-16	46.923	-8E+00	1.298	-0.128	0.007	0.000	3E-06	0.000	0.000	-3E-13	0.000	40.012	38.75
10.00	3.40	15.67	0.042	0.902	0.396	0.076	0.006	2E-04	4E-06	3E-08	9E-11	1E-13	7E-17	2E-20	45.966	-7E+00	0.775	-0.047	0.001	0.000	1E-07	0.000	0.000	-2E-16	0.000	39.977	38.75
15.00	3.80	15.67	0.063	0.857	0.249	0.021	5E-04	4E-06	8E-09	5E-12	8E-16	4E-20	6E-25	2E-30	43.657	-4E+00	0.214	-0.004	2E-05	0.000	2E-11	0.000	0.000	-2E-24	0.000	39.642	37.50
20.00	4.20	15.67	0.084	0.814	0.156	0.006	4E-05	6E-08	1E-11	7E-16	7E-21	1E-26	5E-33	3E-40	41.464	-3E+00	0.059	0.000	3E-07	0.000	3E-15	0.000	0.000	-1E-32	0.000	38.866	37.50
30.00	4.60	15.67	0.125	0.734	0.062	4E-04	3E-07	1E-11	6E-17	2E-23	6E-31	2E-39	3E-49	6E-60	37.404	-1E+00	0.004	0.000	8E-11	0.000	8E-23	0.000	0.000	-9E-49	0.000	36.357	35.00
40.00	5.00	15.67	0.167	0.662	0.024	3E-05	2E-09	3E-15	2E-22	6E-31	5E-41	2E-52	2E-65	1E-79	33.741	-4E-01	0.000	0.000	2E-14	0.000	2E-30	0.000	0.000	-6E-65	0.000	33.325	31.25
50.00	5.20	15.67	0.209	0.597	0.01	3E-06	1E-11	7E-19	8E-28	2E-38	4E-51	2E-65	2E-81	2E-99	30.436	-2E-01	0.000	0.000	4E-18	0.000	6E-38	0.000	0.000	-4E-81	0.000	30.272	28.13
60.00	5.60	15.67	0.251	0.539	0.004	2E-07	7E-14	2E-22	3E-33	4E-46	4E-61	2E-78	1E-97	#####	27.456	-7E-02	0.000	0.000	1E-21	0.000	2E-45	0.000	0.000	-3E-97	0.000	27.391	25.00
70.00	5.60	15.67	0.293	0.486	0.002	1E-08	4E-16	4E-26	1E-38	1E-53	3E-71	3E-91	#####	#####	24.767	-3E-02	0.000	0.000	2E-25	0.000	4E-53	0.000	0.000	-2E-113	0.000	24.741	23.75
80.01	5.80	15.67	0.335	0.438	6E-04	1E-09	3E-18	1E-29	5E-44	3E-61	3E-81	#####	#####	#####	22.341	-1E-02	0.000	0.000	6E-29	0.000	1E-60	0.000	0.000	-1E-129	0.000	22.331	21.88
90.01	5.80	15.67	0.376	0.396	2E-04	8E-11	2E-20	2E-33	2E-49	8E-69	2E-91	#####	#####	#####	20.153	-4E-03	0.000	0.000	1E-32	0.000	3E-68	0.000	0.000	-1E-145	0.000	20.149	21.25
100.01	6.00	15.67	0.418	0.357	9E-05	6E-12	1E-22	6E-37	7E-55	2E-76	#####	#####	#####	#####	18.180	-2E-03	7E-11	0.000	3E-36	0.000	9E-76	0.000	0.000	-7E-162	0.000	18.178	18.75
110.01	6.00	15.67	0.46	0.322	4E-05	5E-13	7E-25	1E-40	3E-60	6E-84	#####	#####	#####	#####	16.399	-6E-04	5E-12	0.000	7E-40	0.000	2E-83	0.000	0.000	-5E-178	0.000	16.399	17.50
120.01	6.00	15.67	0.502	0.29	1E-05	4E-14	5E-27	3E-44	1E-65	2E-91	#####	#####	#####	#####	14.793	-2E-04	4E-13	0.000	2E-43	0.000	7E-91	0.000	0.000	-3E-194	0.000	14.793	16.25
180.00	6.40	15.67	0.753	0.156	6E-08	7E-21	3E-40	6E-66	3E-98	#####	#####	#####	#####	0	7.972	-1E-06	7E-20	0.000	3E-65	0.000	#####	0.000	0.000	-4E-291	0.000	7.972	12.50
244.98	6.60	15.67	1.024	0.08	1E-10	4E-28	2E-54	2E-89	#####	#####	#####	#####	0	0	4.080	-2E-09	4E-27	0.000	9E-89	0.000	#####	0.000	0.000	0E+00	0.000	4.080	9.38
307.98	6.6	15.67	1.288	0.042	4E-13	3E-35	3E-68	#####	#####	#####	#####	0	0	0	2.132	-7E-12	4E-34	0.000	#####	0.000	#####	0.000	0.000	0E+00	0.000	2.132	6.25
366	6.8	16.67	1.628	0.018	2E-16	3E-44	4E-86	#####	#####	#####	#####	0	0	0	0.922	-4E-15	3E-43	0.000	#####	0.000	#####	0.000	0.000	0E+00	0.000	0.922	3.13
403	6.8	17.67	1.9	0.009	5E-19	1E-51	#####	#####	#####	#####	#####	0	0	0	0.471	-8E-18	1E-50	0.000	#####	0.000	#####	0.000	0.000	0E+00	0.000	0.471	1.25
423	6.8	18.67	2.107	0.006	5E-21	4E-57	#####	#####	#####	#####	#####	0	0	0	0.283	-8E-20	4E-56	0.000	#####	0.000	#####	0.000	0.000	0E+00	0.000	0.283	0.00
1388	7.2	19.67	7.285	2E-08	7E-71	#####	0	0	0	0	0	0	0	0	0.000	-1E-69	1E-194	0.000	0	0.000	0	0.000	0.000	0E+00	0.000	0.000	0.00

Table 6

Calculation of Settlement using Terzaghi's Model
Remoulded Madiwela Peat without cement with pore pressure measurement

$H_{dr} =$	28.2 mm	$U_o =$	40 kN/m ²	$\delta_t =$	6.8 mm
$C_v =$	15.67 mm ² /min	$Z =$	28.18 mm		

M = $(\pi/2) \cdot (2m+1)$											
m = 0	m = 1	m = 2	m = 3	m = 4	m = 5	m = 6	m = 7	m = 8	m = 9	m = 10	m = 11
1.57	4.71	7.85	10.99	14.13	17.27	20.41	23.55	26.69	29.83	32.97	36.11

0	measured δ	C_v	T_v	$e^{-M^2 \cdot T_v}$										$(2/M^2) \cdot (e^{-M^2 \cdot T_v}) \dots (A)$										SUM of (A)	U=1-Sum (A)	$\delta = \delta_t \cdot U$		
				m = 0	m = 1	m = 2	m = 3	m = 4	m = 5	m = 6	m = 7	m = 8	m = 9	m = 10	m = 0	m = 1	m = 2	m = 3	m = 4	m = 5	m = 6	m = 7	m = 8				m = 9	m = 10
0	0.00	15.67	0	1	1	1	1	1	1	1	1	1	1	1	0.811	0.090	0.032	0.017	0.010	0.007	0.005	0.004	0.003	0.002	0.002	0.983	0.017	0.170
0.10	0.60	15.67	4E-04	0.999	0.991	0.975	0.951	0.92	0.883	0.84	0.793	0.742	0.689	0.635	0.811	0.089	0.032	0.016	0.009	0.006	0.004	0.003	0.002	0.002	0.001	0.974	0.026	0.253
0.15	0.80	15.67	6E-04	0.998	0.986	0.962	0.927	0.882	0.829	0.77	0.706	0.64	0.572	0.506	0.810	0.089	0.031	0.015	0.009	0.006	0.004	0.003	0.002	0.001	0.001	0.970	0.030	0.290
0.25	0.80	15.67	0.001	0.997	0.977	0.938	0.881	0.812	0.732	0.647	0.56	0.475	0.395	0.321	0.809	0.088	0.030	0.015	0.008	0.005	0.003	0.002	0.001	0.001	0.001	0.963	0.037	0.357
0.50	1.20	15.67	0.002	0.995	0.955	0.879	0.777	0.659	0.536	0.419	0.314	0.226	0.156	0.103	0.807	0.086	0.029	0.013	0.007	0.004	0.002	0.001	0.001	0.000	0.000	0.949	0.051	0.496
1.00	1.40	15.67	0.004	0.99	0.911	0.773	0.604	0.434	0.287	0.175	0.098	0.051	0.024	0.011	0.803	0.082	0.025	0.010	0.004	0.002	0.001	0.000	0.000	0.000	0.000	0.928	0.072	0.703
1.50	1.60	15.67	0.006	0.985	0.87	0.679	0.469	0.285	0.154	0.073	0.034	0.014	0.004	0.001	0.799	0.078	0.022	0.008	0.003	0.001	0.000	0.000	0.000	0.000	0.000	0.912	0.088	0.863
2.00	1.80	15.67	0.008	0.98	0.831	0.597	0.364	0.188	0.083	0.031	0.01	0.003	6E-04	1E-04	0.795	0.075	0.019	0.006	0.002	0.001	0.000	0.000	0.000	0.000	0.000	0.898	0.102	0.998
3.00	2.20	15.67	0.013	0.97	0.757	0.462	0.22	0.082	0.024	0.005	1E-03	1E-04	1E-05	1E-06	0.787	0.068	0.015	0.004	0.001	0.000	0.000	0.000	0.000	0.000	0.000	0.875	0.125	1.224
4.00	2.60	15.67	0.017	0.96	0.69	0.357	0.133	0.035	0.007	9E-04	9E-05	7E-06	3E-07	1E-08	0.779	0.062	0.012	0.002	0.000	0.000	0.000	0.000	0.000	0.000	0.000	0.855	0.145	1.415
5.00	2.60	15.67	0.021	0.95	0.629	0.276	0.08	0.015	0.002	2E-04	9E-06	3E-07	8E-09	1E-10	0.771	0.057	0.009	0.001	0.000	0.000	0.000	0.000	0.000	0.000	0.000	0.838	0.162	1.583
6.00	3.00	15.67	0.025	0.94	0.573	0.213	0.048	0.007	6E-04	3E-05	9E-07	2E-08	2E-10	1E-12	0.763	0.052	0.007	0.001	0.000	0.000	0.000	0.000	0.000	0.000	0.000	0.822	0.178	1.735
7.00	3.20	15.67	0.029	0.93	0.522	0.165	0.029	0.003	2E-04	5E-06	9E-08	9E-10	5E-12	2E-14	0.755	0.047	0.005	0.000	0.000	0.000	0.000	0.000	0.000	0.000	0.000	0.808	0.192	1.875
8.00	3.20	15.67	0.033	0.921	0.476	0.127	0.018	0.001	5E-05	9E-07	9E-09	4E-11	1E-13	2E-16	0.747	0.043	0.004	0.000	0.000	0.000	0.000	0.000	0.000	0.000	0.000	0.795	0.205	2.005
10.00	3.40	15.67	0.042	0.902	0.396	0.076	0.006	2E-04	4E-06	3E-08	9E-11	1E-13	7E-17	2E-20	0.732	0.036	0.002	0.000	0.000	0.000	0.000	0.000	0.000	0.000	0.000	0.770	0.230	2.243
15.00	3.80	15.67	0.063	0.857	0.249	0.021	5E-04	4E-06	8E-09	5E-12	8E-16	4E-20	6E-25	2E-30	0.695	0.022	0.001	0.000	0.000	0.000	0.000	0.000	0.000	0.000	0.000	0.718	0.282	2.749
20.00	4.20	15.67	0.084	0.814	0.156	0.006	4E-05	6E-08	1E-11	7E-16	7E-21	1E-26	5E-33	3E-40	0.660	0.014	0.000	0.000	0.000	0.000	0.000	0.000	0.000	0.000	0.000	0.675	0.325	3.176
30.00	4.60	15.67	0.125	0.734	0.062	4E-04	3E-07	1E-11	6E-17	2E-23	6E-31	2E-39	3E-49	6E-60	0.596	0.006	0.000	0.000	0.000	0.000	0.000	0.000	0.000	0.000	0.000	0.601	0.399	3.892
40.00	5.00	15.67	0.167	0.662	0.024	3E-05	2E-09	3E-15	2E-22	6E-31	5E-41	2E-52	2E-65	1E-79	0.537	0.002	0.000	0.000	0.000	0.000	0.000	0.000	0.000	0.000	0.000	0.539	0.461	4.495
50.00	5.20	15.67	0.209	0.597	0.01	3E-06	1E-11	7E-19	8E-28	2E-38	4E-51	2E-65	2E-81	2E-99	0.485	0.001	0.000	0.000	0.000	0.000	0.000	0.000	0.000	0.000	0.000	0.486	0.514	5.021
60.00	5.60	15.67	0.251	0.539	0.004	2E-07	7E-14	2E-22	3E-33	4E-46	4E-61	2E-78	1E-97	#####	0.437	0.000	0.000	0.000	0.000	0.000	0.000	0.000	0.000	0.000	0.000	0.438	0.562	5.490
70.00	5.60	15.67	0.293	0.486	0.002	1E-08	4E-16	4E-26	1E-38	1E-53	3E-71	3E-91	#####	#####	0.394	0.000	0.000	0.000	0.000	0.000	0.000	0.000	0.000	0.000	0.000	0.395	0.605	5.910
80.01	5.80	15.67	0.335	0.438	6E-04	1E-09	3E-18	1E-29	5E-44	3E-61	3E-81	#####	#####	#####	0.356	0.000	0.000	0.000	0.000	0.000	0.000	0.000	0.000	0.000	0.000	0.356	0.644	6.287
90.01	5.80	15.67	0.376	0.396	2E-04	8E-11	2E-20	2E-33	2E-49	8E-69	2E-91	#####	#####	#####	0.321	0.000	0.000	0.000	0.000	0.000	0.000	0.000	0.000	0.000	0.000	0.321	0.679	6.628
####	6.00	15.67	0.418	0.357	9E-05	6E-12	1E-22	6E-37	7E-55	2E-76	#####	#####	#####	#####	0.289	0.000	0.000	0.000	0.000	0.000	0.000	0.000	0.000	0.000	0.000	0.289	0.711	6.935
####	6.00	15.67	0.46	0.322	4E-05	5E-13	7E-25	1E-40	3E-60	6E-84	#####	#####	#####	#####	0.261	0.000	0.000	0.000	0.000	0.000	0.000	0.000	0.000	0.000	0.000	0.261	0.739	7.211
####	6.00	15.67	0.502	0.29	1E-05	4E-14	5E-27	3E-44	1E-65	2E-91	#####	#####	#####	#####	0.236	0.000	0.000	0.000	0.000	0.000	0.000	0.000	0.000	0.000	0.000	0.236	0.764	7.461
####	6.40	15.67	0.753	0.156	6E-08	7E-21	3E-40	6E-66	3E-98	#####	#####	#####	#####	0	0.127	0.000	0.000	0.000	0.000	0.000	0.000	0.000	0.000	0.000	0.000	0.127	0.873	8.521
####	6.60	15.67	1.024	0.08	1E-10	4E-28	2E-54	2E-89	#####	#####	#####	#####	0	0	0.065	0.000	0.000	0.000	0.000	0.000	0.000	0.000	0.000	0.000	0.000	0.065	0.935	9.126
####	6.6	15.67	1.288	0.042	4E-13	3E-35	3E-68	#####	#####	#####	#####	0	0	0	0.034	0.000	0.000	0.000	0.000	0.000	0.000	0.000	0.000	0.000	0.000	0.034	0.966	9.429
366	6.8	16.67	1.628	0.018	2E-16	3E-44	4E-86	#####	#####	#####	#####	0	0	0	0.015	0.000	0.000	0.000	0.000	0.000	0.000	0.000	0.000	0.000	0.000	0.015	0.985	9.617
403	6.8	17.67	1.9	0.009	5E-19	1E-51	#####	#####	#####	#####	#####	0	0	0	0.008	0.000	0.000	0.000	0.000	0.000	0.000	0.000	0.000	0.000	0.000	0.008	0.992	9.687
423	6.8	18.67	2.107	0.006	5E-21	4E-57	#####	#####	#####	#####	#####	0	0	0	0.005	0.000	0.000	0.000	0.000	0.000	0.000	0.000	0.000	0.000	0.000	0.005	0.995	9.716
1388	7.2	19.67	7.285	2E-08	7E-71	#####	0	0	0	0	0	0	0	0	0.000	0.000	0.000	0.000	0.000	0.000	0.000	0.000	0.000	0.000	0.000	0.000	1.000	9.760

Table 7

Calculation of Settlement using Terzaghi's Model
Remoulded Madiwela Peat without cement with pore pressure measurement

$H_{dr} =$ 28.2 mm	$U_0 =$ 40 kN/m ²	$\delta =$ 6.8 mm
$C_v =$ 15.67 mm ² /min	$Z =$ 28.18 mm	

$M = (\pi/2) \cdot (2m+1)$											
m=0	m=1	m=2	m=3	m=4	m=5	m=6	m=7	m=8	m=9	m=10	m=11
1.57	4.71	7.85	10.99	14.13	17.27	20.41	23.55	26.69	29.83	32.97	36.11

0	measured δ	C_v	T_v	$e^{-M^2 \cdot T_v}$											$(2/M^2) \cdot (e^{-M^2 \cdot T_v}) \cdot (A)$											SUM of (A)	U=1-Sum (A)	$\delta = \delta_t \cdot U$
				m=0	m=1	m=2	m=3	m=4	m=5	m=6	m=7	m=8	m=9	m=10	m=0	m=1	m=2	m=3	m=4	m=5	m=6	m=7	m=8	m=9	m=10			
0	0.00	15.67	0.000	1.000	1.000	1.000	1.000	1.000	1.000	1.000	1.000	1.000	1.000	1.000	0.811	0.090	0.032	0.017	0.010	0.007	0.005	0.004	0.003	0.002	0.002	0.983	0.017	0.118
0.10	0.60	15.67	0.000	0.999	0.991	0.975	0.951	0.920	0.883	0.840	0.793	0.742	0.689	0.635	0.811	0.089	0.032	0.016	0.009	0.006	0.004	0.003	0.002	0.002	0.001	0.974	0.026	0.176
0.15	0.80	15.67	0.001	0.998	0.986	0.962	0.927	0.882	0.829	0.770	0.706	0.640	0.572	0.506	0.810	0.089	0.031	0.015	0.009	0.006	0.004	0.003	0.002	0.001	0.001	0.970	0.030	0.202
0.25	0.80	15.67	0.001	0.997	0.977	0.938	0.881	0.812	0.732	0.647	0.560	0.475	0.395	0.321	0.809	0.088	0.030	0.015	0.008	0.005	0.003	0.002	0.001	0.001	0.001	0.963	0.037	0.249
0.50	1.20	15.67	0.002	0.995	0.955	0.879	0.777	0.659	0.536	0.419	0.314	0.226	0.156	0.103	0.807	0.086	0.029	0.013	0.007	0.004	0.002	0.001	0.001	0.000	0.000	0.949	0.051	0.345
1.00	1.40	15.67	0.004	0.990	0.911	0.773	0.604	0.434	0.287	0.175	0.098	0.051	0.024	0.011	0.803	0.082	0.025	0.010	0.004	0.002	0.001	0.000	0.000	0.000	0.000	0.928	0.072	0.490
1.50	1.60	15.67	0.006	0.985	0.870	0.679	0.469	0.286	0.154	0.073	0.031	0.011	0.004	0.001	0.799	0.078	0.022	0.008	0.003	0.001	0.000	0.000	0.000	0.000	0.000	0.912	0.088	0.601
2.00	1.80	15.67	0.008	0.980	0.831	0.597	0.364	0.188	0.083	0.031	0.010	0.003	0.001	0.000	0.795	0.075	0.019	0.006	0.002	0.001	0.000	0.000	0.000	0.000	0.000	0.898	0.102	0.695
3.00	2.20	15.67	0.013	0.970	0.757	0.462	0.220	0.082	0.024	0.005	0.001	0.000	0.000	0.000	0.787	0.068	0.015	0.004	0.001	0.000	0.000	0.000	0.000	0.000	0.000	0.875	0.125	0.853
4.00	2.60	15.67	0.017	0.960	0.690	0.357	0.133	0.035	0.007	0.001	0.000	0.000	0.000	0.000	0.779	0.062	0.012	0.002	0.000	0.000	0.000	0.000	0.000	0.000	0.000	0.855	0.145	0.986
5.00	2.60	15.67	0.021	0.950	0.629	0.276	0.080	0.015	0.002	0.000	0.000	0.000	0.000	0.000	0.771	0.057	0.009	0.001	0.000	0.000	0.000	0.000	0.000	0.000	0.000	0.838	0.162	1.103
6.00	3.00	15.67	0.025	0.940	0.573	0.213	0.048	0.007	0.001	0.000	0.000	0.000	0.000	0.000	0.763	0.052	0.007	0.001	0.000	0.000	0.000	0.000	0.000	0.000	0.000	0.822	0.178	1.209
7.00	3.20	15.67	0.029	0.930	0.522	0.165	0.029	0.003	0.000	0.000	0.000	0.000	0.000	0.000	0.755	0.047	0.005	0.000	0.000	0.000	0.000	0.000	0.000	0.000	0.000	0.808	0.192	1.306
8.00	3.20	15.67	0.033	0.921	0.476	0.127	0.018	0.001	0.000	0.000	0.000	0.000	0.000	0.000	0.747	0.043	0.004	0.000	0.000	0.000	0.000	0.000	0.000	0.000	0.000	0.795	0.205	1.397
10.00	3.40	15.67	0.042	0.902	0.396	0.076	0.006	0.000	0.000	0.000	0.000	0.000	0.000	0.000	0.732	0.036	0.002	0.000	0.000	0.000	0.000	0.000	0.000	0.000	0.000	0.770	0.230	1.563
15.00	3.80	15.67	0.063	0.857	0.249	0.021	0.001	0.000	0.000	0.000	0.000	0.000	0.000	0.000	0.695	0.022	0.001	0.000	0.000	0.000	0.000	0.000	0.000	0.000	0.000	0.718	0.282	1.916
20.00	4.20	15.67	0.084	0.814	0.156	0.006	0.000	0.000	0.000	0.000	0.000	0.000	0.000	0.000	0.660	0.014	0.000	0.000	0.000	0.000	0.000	0.000	0.000	0.000	0.000	0.675	0.325	2.213
30.00	4.60	15.67	0.125	0.734	0.062	0.000	0.000	0.000	0.000	0.000	0.000	0.000	0.000	0.000	0.596	0.006	0.000	0.000	0.000	0.000	0.000	0.000	0.000	0.000	0.000	0.601	0.399	2.712
40.00	5.00	15.67	0.167	0.662	0.024	0.000	0.000	0.000	0.000	0.000	0.000	0.000	0.000	0.000	0.537	0.002	0.000	0.000	0.000	0.000	0.000	0.000	0.000	0.000	0.000	0.539	0.461	3.132
50.00	5.20	15.67	0.209	0.597	0.010	0.000	0.000	0.000	0.000	0.000	0.000	0.000	0.000	0.000	0.485	0.001	0.000	0.000	0.000	0.000	0.000	0.000	0.000	0.000	0.000	0.486	0.514	3.498
60.00	5.60	15.67	0.251	0.539	0.004	0.000	0.000	0.000	0.000	0.000	0.000	0.000	0.000	0.000	0.437	0.000	0.000	0.000	0.000	0.000	0.000	0.000	0.000	0.000	0.000	0.438	0.562	3.825
70.00	5.60	15.67	0.293	0.486	0.002	0.000	0.000	0.000	0.000	0.000	0.000	0.000	0.000	0.000	0.394	0.000	0.000	0.000	0.000	0.000	0.000	0.000	0.000	0.000	0.000	0.395	0.605	4.117
80.00	5.80	15.67	0.335	0.438	0.001	0.000	0.000	0.000	0.000	0.000	0.000	0.000	0.000	0.000	0.356	0.000	0.000	0.000	0.000	0.000	0.000	0.000	0.000	0.000	0.000	0.356	0.644	4.381
90.00	5.80	15.67	0.376	0.396	0.000	0.000	0.000	0.000	0.000	0.000	0.000	0.000	0.000	0.000	0.321	0.000	0.000	0.000	0.000	0.000	0.000	0.000	0.000	0.000	0.000	0.321	0.679	4.618
100.00	6.00	15.67	0.418	0.357	0.000	0.000	0.000	0.000	0.000	0.000	0.000	0.000	0.000	0.000	0.289	0.000	0.000	0.000	0.000	0.000	0.000	0.000	0.000	0.000	0.000	0.289	0.711	4.831
110.00	6.00	15.67	0.460	0.322	0.000	0.000	0.000	0.000	0.000	0.000	0.000	0.000	0.000	0.000	0.261	0.000	0.000	0.000	0.000	0.000	0.000	0.000	0.000	0.000	0.000	0.261	0.739	5.024
120.00	6.00	15.67	0.502	0.290	0.000	0.000	0.000	0.000	0.000	0.000	0.000	0.000	0.000	0.000	0.236	0.000	0.000	0.000	0.000	0.000	0.000	0.000	0.000	0.000	0.000	0.236	0.764	5.198
180.00	6.40	15.67	0.753	0.156	0.000	0.000	0.000	0.000	0.000	0.000	0.000	0.000	0.000	0.000	0.127	0.000	0.000	0.000	0.000	0.000	0.000	0.000	0.000	0.000	0.000	0.127	0.873	5.937
245.00	6.60	15.67	1.024	0.080	0.000	0.000	0.000	0.000	0.000	0.000	0.000	0.000	0.000	0.000	0.065	0.000	0.000	0.000	0.000	0.000	0.000	0.000	0.000	0.000	0.000	0.065	0.935	6.358
308.00	6.6	15.67	1.288	0.042	0.000	0.000	0.000	0.000	0.000	0.000	0.000	0.000	0.000	0.000	0.034	0.000	0.000	0.000	0.000	0.000	0.000	0.000	0.000	0.000	0.000	0.034	0.966	6.569
366.00	6.8	15.67	1.530	0.023	0.000	0.000	0.000	0.000	0.000	0.000	0.000	0.000	0.000	0.000	0.019	0.000	0.000	0.000	0.000	0.000	0.000	0.000	0.000	0.000	0.000	0.019	0.981	6.673
403.00	6.8	15.67	1.685	0.016	0.000	0.000	0.000	0.000	0.000	0.000	0.000	0.000	0.000	0.000	0.013	0.000	0.000	0.000	0.000	0.000	0.000	0.000	0.000	0.000	0.000	0.013	0.987	6.713
423.00	6.8	15.67	1.769	0.013	0.000	0.000	0.000	0.000	0.000	0.000	0.000	0.000	0.000	0.000	0.010	0.000	0.000	0.000	0.000	0.000	0.000	0.000	0.000	0.000	0.000	0.010	0.990	6.729
1388	7.2	15.67	5.803	0.000	0.000	0.000	0.000	0.000	0.000	0.000	0.000	0.000	0.000	0.000	0.000	0.000	0.000	0.000	0.000	0.000	0.000	0.000	0.000	0.000	0.000	0.000	1.000	6.800
1813	7.2	15.67	7.580	0.000	0.000	0.000	0.000	0.000	0.000	0.000	0.000	0.000	0.000	0.000	0.000	0.000	0.000	0.000	0.000	0.000	0.000	0.000	0.000	0.000	0.000	0.000	1.000	6.800
3253	7.2	15.67	13.601	0.000	0.000	0.000	0.000	0.000	0.000	0.000	0.000	0.000	0.000	0.000	0.000	0.000	0.000	0.000	0.000	0.000	0.000	0.000	0.000	0.000	0.000	0.000	1.000	6.800
5683	7.4	15.67	23.761	0.000	0.000	0.000	0.000	0.000	0.000	0.000	0.000	0.000	0.000	0.000	0.000	0.000	0.000	0.000	0.000	0.000	0.000	0.000	0.000	0.000	0.000	0.000	1.000	6.800
7093	7.4	15.67	29.656	0.000	0.000	0.000	0.000	0.000	0.000	0.000	0.000	0.000	0.000	0.000	0.000	0.000	0.000	0.000	0.000	0.000	0.000	0.000	0.000	0.000	0.000	0.000	1.000	6.800
8533	7.4	15.67	35.677	0.000	0.000	0.000	0.000	0.000	0.000	0.000	0.000	0.000	0.000	0.000	0.000	0.000	0.000	0.000	0.000	0.000	0.000	0.000	0.000	0.000	0.000	0.000	1.000	6.800
9943	7.4	1																										

Calculation of Settlement using Terzaghi's Model
Remoulded Madiwela Peat with 10% cement with pore pressure measurement

$H_{dr} =$	61.2 mm	$U_o =$	40 kN/m ²	$\delta =$	9.76 mm
$C_v =$	73.83 mm ² /min	$Z =$	61.22 mm		

$M = (\pi/2) * (2m+1)$											
m = 0	m = 1	m = 2	m = 3	m = 4	m = 5	m = 6	m = 7	m = 8	m = 9	m = 10	m = 11
1.57	4.71	7.85	10.99	14.13	17.27	20.41	23.55	26.69	29.83	32.97	36.11

t	measured δ	C_v	T_v	$e^{-M^2 * T_v}$											$(2 / M^2) * (e^{-M^2 * T_v}) \text{-----(A)}$											SUM of (A)	U=1-Sum (A)	$\delta t = \delta * U$
				m=0	m=1	m=2	m=3	m=4	m=5	m=6	m=7	m=8	m=9	m=10	m=0	m=1	m=2	m=3	m=4	m=5	m=6	m=7	m=8	m=9	m=10			
0	0.00	73.83	0	1.000	1.000	1.000	1.000	1.000	1.000	1.000	1.000	1.000	1.000	0.811	0.090	0.032	0.017	0.010	0.007	0.005	0.004	0.003	0.002	0.002	0.983	0.017	0.170	
0.25	1.41	73.83	0.0049	0.988	0.897	0.738	0.552	0.374	0.230	0.129	0.065	0.030	0.012	0.005	0.802	0.081	0.024	0.009	0.004	0.002	0.001	0.000	0.000	0.000	0.922	0.078	0.763	
0.5	1.55	73.83	0.0099	0.976	0.804	0.545	0.304	0.140	0.053	0.017	0.004	0.001	0.000	0.000	0.792	0.072	0.018	0.005	0.001	0.000	0.000	0.000	0.000	0.000	0.889	0.111	1.084	
1.0	2.09	73.83	0.0197	0.953	0.646	0.297	0.093	0.020	0.003	0.000	0.000	0.000	0.000	0.000	0.773	0.058	0.010	0.002	0.000	0.000	0.000	0.000	0.000	0.000	0.843	0.157	1.537	
1.5	2.47	73.83	0.0296	0.930	0.519	0.162	0.028	0.003	0.000	0.000	0.000	0.000	0.000	0.000	0.754	0.047	0.005	0.000	0.000	0.000	0.000	0.000	0.000	0.000	0.807	0.193	1.884	
2.0	3.00	73.83	0.0394	0.907	0.417	0.088	0.009	0.000	0.000	0.000	0.000	0.000	0.000	0.000	0.736	0.038	0.003	0.000	0.000	0.000	0.000	0.000	0.000	0.000	0.777	0.223	2.177	
4.0	3.66	73.83	0.0788	0.823	0.174	0.008	0.000	0.000	0.000	0.000	0.000	0.000	0.000	0.000	0.668	0.016	0.000	0.000	0.000	0.000	0.000	0.000	0.000	0.000	0.684	0.316	3.083	
5.0	4.17	73.83	0.0985	0.784	0.112	0.002	0.000	0.000	0.000	0.000	0.000	0.000	0.000	0.000	0.636	0.010	0.000	0.000	0.000	0.000	0.000	0.000	0.000	0.000	0.647	0.353	3.448	
6.0	4.26	73.83	0.1182	0.747	0.073	0.001	0.000	0.000	0.000	0.000	0.000	0.000	0.000	0.000	0.606	0.007	0.000	0.000	0.000	0.000	0.000	0.000	0.000	0.000	0.613	0.387	3.778	
8.0	4.65	73.83	0.1576	0.678	0.030	0.000	0.000	0.000	0.000	0.000	0.000	0.000	0.000	0.000	0.550	0.003	0.000	0.000	0.000	0.000	0.000	0.000	0.000	0.000	0.553	0.447	4.363	
15.0	5.72	73.83	0.2955	0.483	0.001	0.000	0.000	0.000	0.000	0.000	0.000	0.000	0.000	0.000	0.392	0.000	0.000	0.000	0.000	0.000	0.000	0.000	0.000	0.000	0.392	0.608	5.936	
20.0	6.26	73.83	0.394	0.379	0.000	0.000	0.000	0.000	0.000	0.000	0.000	0.000	0.000	0.000	0.307	0.000	0.000	0.000	0.000	0.000	0.000	0.000	0.000	0.000	0.307	0.693	6.761	
30.0	7.01	73.83	0.591	0.233	0.000	0.000	0.000	0.000	0.000	0.000	0.000	0.000	0.000	0.000	0.189	0.000	0.000	0.000	0.000	0.000	0.000	0.000	0.000	0.000	0.189	0.811	7.915	
40.0	7.83	73.83	0.788	0.143	0.000	0.000	0.000	0.000	0.000	0.000	0.000	0.000	0.000	0.000	0.116	0.000	0.000	0.000	0.000	0.000	0.000	0.000	0.000	0.000	0.116	0.884	8.625	
50.0	8.00	73.83	0.985	0.088	0.000	0.000	0.000	0.000	0.000	0.000	0.000	0.000	0.000	0.000	0.072	0.000	0.000	0.000	0.000	0.000	0.000	0.000	0.000	0.000	0.072	0.928	9.061	
61.0	8.34	73.83	1.2017	0.052	0.000	0.000	0.000	0.000	0.000	0.000	0.000	0.000	0.000	0.000	0.042	0.000	0.000	0.000	0.000	0.000	0.000	0.000	0.000	0.000	0.042	0.958	9.350	
73.0	8.82	73.83	1.4381	0.029	0.000	0.000	0.000	0.000	0.000	0.000	0.000	0.000	0.000	0.000	0.023	0.000	0.000	0.000	0.000	0.000	0.000	0.000	0.000	0.000	0.023	0.977	9.531	
90.0	8.89	73.83	1.773	0.013	0.000	0.000	0.000	0.000	0.000	0.000	0.000	0.000	0.000	0.000	0.010	0.000	0.000	0.000	0.000	0.000	0.000	0.000	0.000	0.000	0.010	0.990	9.660	
103.0	8.98	73.83	2.0291	0.007	0.000	0.000	0.000	0.000	0.000	0.000	0.000	0.000	0.000	0.000	0.005	0.000	0.000	0.000	0.000	0.000	0.000	0.000	0.000	0.000	0.005	0.995	9.707	
110.0	9.01	73.83	2.167	0.005	0.000	0.000	0.000	0.000	0.000	0.000	0.000	0.000	0.000	0.000	0.004	0.000	0.000	0.000	0.000	0.000	0.000	0.000	0.000	0.000	0.004	0.996	9.722	
140.0	9.16	73.83	2.758	0.001	0.000	0.000	0.000	0.000	0.000	0.000	0.000	0.000	0.000	0.000	0.001	0.000	0.000	0.000	0.000	0.000	0.000	0.000	0.000	0.000	0.001	0.999	9.751	
161.0	9.27	73.83	3.1717	0.000	0.000	0.000	0.000	0.000	0.000	0.000	0.000	0.000	0.000	0.000	0.000	0.000	0.000	0.000	0.000	0.000	0.000	0.000	0.000	0.000	0.000	1.000	9.757	
187.0	9.37	73.83	3.6839	0.000	0.000	0.000	0.000	0.000	0.000	0.000	0.000	0.000	0.000	0.000	0.000	0.000	0.000	0.000	0.000	0.000	0.000	0.000	0.000	0.000	0.000	1.000	9.759	
220.0	9.52	73.83	4.334	0.000	0.000	0.000	0.000	0.000	0.000	0.000	0.000	0.000	0.000	0.000	0.000	0.000	0.000	0.000	0.000	0.000	0.000	0.000	0.000	0.000	0.000	1.000	9.760	
240.0	9.58	73.83	4.728	0.000	0.000	0.000	0.000	0.000	0.000	0.000	0.000	0.000	0.000	0.000	0.000	0.000	0.000	0.000	0.000	0.000	0.000	0.000	0.000	0.000	0.000	1.000	9.760	
271.0	9.68	73.83	5.3387	0.000	0.000	0.000	0.000	0.000	0.000	0.000	0.000	0.000	0.000	0.000	0.000	0.000	0.000	0.000	0.000	0.000	0.000	0.000	0.000	0.000	0.000	1.000	9.760	
290.0	9.77	73.83	5.713	0.000	0.000	0.000	0.000	0.000	0.000	0.000	0.000	0.000	0.000	0.000	0.000	0.000	0.000	0.000	0.000	0.000	0.000	0.000	0.000	0.000	0.000	1.000	9.760	
300.0	9.77	73.83	5.91	0.000	0.000	0.000	0.000	0.000	0.000	0.000	0.000	0.000	0.000	0.000	0.000	0.000	0.000	0.000	0.000	0.000	0.000	0.000	0.000	0.000	0.000	1.000	9.760	
360.0	9.89	73.83	7.092	0.000	0.000	0.000	0.000	0.000	0.000	0.000	0.000	0.000	0.000	0.000	0.000	0.000	0.000	0.000	0.000	0.000	0.000	0.000	0.000	0.000	0.000	1.000	9.760	
375.0	9.92	73.83	7.3875	0.000	0.000	0.000	0.000	0.000	0.000	0.000	0.000	0.000	0.000	0.000	0.000	0.000	0.000	0.000	0.000	0.000	0.000	0.000	0.000	0.000	0.000	1.000	9.760	
1020	10.71	73.83	20.094	0.000	0.000	0.000	0.000	0.000	0.000	0.000	0.000	0.000	0.000	0.000	0.000	0.000	0.000	0.000	0.000	0.000	0.000	0.000	0.000	0.000	0.000	1.000	9.760	
2910	10.94	73.83	57.327	0.000	0.000	0.000	0.000	0.000	0.000	0.000	0.000	0.000	0.000	0.000	0.000	0.000	0.000	0.000	0.000	0.000	0.000	0.000	0.000	0.000	0.000	1.000	9.760	
3263	10.98	73.83	64.281	0.000	0.000	0.000	0.000	0.000	0.000	0.000	0.000	0.000	0.000	0.000	0.000	0.000	0.000	0.000	0.000	0.000	0.000	0.000	0.000	0.000	0.000	1.000	9.760	
4365	11.12	73.83	85.991	0.000	0.000	0.000	0.000	0.000	0.000	0.000	0.000	0.000	0.000	0.000	0.000	0.000	0.000	0.000	0.000	0.000	0.000	0.000	0.000	0.000	0.000	1.000	9.760	
11540	11.65	73.83	227.34	0.000	0.000	0.000	0.000	0.000	0.000	0.000	0.000	0.000	0.000	0.000	0.000	0.000	0.000	0.000	0.000	0.000	0.000	0.000	0.000	0.000	0.000	1.000	9.760	
11850	11.66	73.83	233.44	0.000	0.000	0.000	0.000	0.000	0.000	0.000	0.000	0.000	0.000	0.000	0.000	0.000	0.000	0.000	0.000	0.000	0.000	0.000	0.000	0.000	0.000	1.000	9.760	
32026	12.06	73.83	630.91	0.000	0.000	0.000	0.000	0.000	0.000	0.000	0.000	0.000	0.000	0.000	0.000	0.000	0.000	0.000	0.000	0.000	0.000	0.000	0.000	0.000	0.000	1.000	9.760	

Table 7

Calculation of Pore Water Pressure using Terzaghi's Model
Remoulded Madiwela Peat with 10% cement with pore pressure measurement

$H_{dr} =$	61.2 mm	$U_o =$	40 kN/m ²
$C_v =$	28.48 mm ² /min	$Z =$	61.22 mm

$M = (\pi/2) * (2m+1)$						$\text{Sin}(M * Z/H_{dr})$						$2U_o/M$						$\text{Sin}(M * Z/H_{dr}) * 2U_o/M$					
m=0	m=1	m=2	m=3	m=4	m=5	m=0	m=1	m=2	m=3	m=4	m=5	m=0	m=1	m=2	m=3	m=4	m=5	m=0	m=1	m=2	m=3	m=4	m=5
1.57	4.71	7.85	10.99	14.13	17.27	1	-1	1	-1	1	-1	50.96	16.99	10.19	7.279	5.662	4.632	50.96	-16.99	10.19	-7.28	5.66	-4.63
m=6	m=7	m=8	m=9	m=10	m=11	m=6	m=7	m=8	m=9	m=10	m=11	m=6	m=7	m=8	m=9	m=10	m=11	m=6	m=7	m=8	m=9	m=10	m=11
20.41	23.55	26.69	29.83	32.97	36.11	1	-1	1	-1	1	-1	3.920	3.397	2.997	2.682	2.426	2.215	3.92	-3.40	3.00	-2.68	2.43	-2.22

t	δ	C_v	T_v	$e^{-M^2 * Tv}$											$(\text{Sin}(M * Z/H_{dr}) * 2U_o/M) * (e^{-M^2 * Tv})$										SUM-U	measured U		
				m=0	m=1	m=2	m=3	m=4	m=5	m=6	m=7	m=8	m=9	m=10	m=0	m=1	m=2	m=3	m=4	m=5	m=6	m=7	m=8	m=9			m=10	
0	0.00	28.48	0	1	1	1	1	1	1	1	1	1	1	1	50.96	-17.0	10.19	-7.28	5.66	-4.63	3.919	-3.397	2.997	-2.682	2.426	41.18	9.375	
0.25	1.41	28.48	0.0019	0.995	0.959	0.890	0.795	0.684	0.567	0.453	0.349	0.258	0.184	0.127	50.72	-16.3	9.07	-5.79	3.87	-2.63	1.776	-1.184	0.774	-0.495	0.308	40.14	12.500	
0.5	1.55	28.48	0.0038	0.991	0.919	0.791	0.632	0.468	0.322	0.205	0.122	0.067	0.034	0.016	50.48	-15.6	8.06	-4.60	2.65	-1.49	0.805	-0.413	0.200	-0.091	0.039	40.03	18.750	
1.0	2.09	28.48	0.0076	0.981	0.845	0.626	0.399	0.219	0.104	0.042	0.015	0.004	0.001	0.000	50.01	-14.4	6.38	-2.91	1.24	-0.48	0.165	-0.050	0.013	-0.003	0.001	40.02	22.500	
1.5	2.47	28.48	0.0114	0.972	0.777	0.495	0.252	0.103	0.033	0.009	0.002	0.000	0.000	0.000	49.54	-13.2	5.05	-1.84	0.58	-0.15	0.034	-0.006	0.001	0.000	0.000	40.02	25.000	
2.0	3.00	28.48	0.0152	0.963	0.714	0.392	0.160	0.048	0.011	0.002	0.000	0.000	0.000	0.000	49.08	-12.1	3.99	-1.16	0.27	-0.05	0.007	-0.001	0.000	0.000	0.000	40.02	28.125	
4.0	3.66	28.48	0.0304	0.928	0.510	0.154	0.025	0.002	0.000	0.000	0.000	0.000	0.000	0.000	47.28	-8.7	1.57	-0.19	0.01	0.00	0.000	0.000	0.000	0.000	0.000	40.02	31.250	
5.0	4.17	28.48	0.038	0.911	0.430	0.096	0.010	0.001	0.000	0.000	0.000	0.000	0.000	0.000	46.40	-7.31	0.98	-0.07	0.00	0.00	0.000	0.000	0.000	0.000	0.000	40.00	31.250	
6.0	4.26	28.48	0.0456	0.894	0.364	0.060	0.004	0.000	0.000	0.000	0.000	0.000	0.000	0.000	45.54	-6.18	0.61	-0.03	0.00	0.00	0.000	0.000	0.000	0.000	0.000	0.000	39.95	31.250
8.0	4.65	28.48	0.0608	0.861	0.260	0.024	0.001	0.000	0.000	0.000	0.000	0.000	0.000	0.000	43.86	-4.41	0.24	0.00	0.00	0.00	0.000	0.000	0.000	0.000	0.000	0.000	39.69	31.250
15.0	5.72	28.48	0.114	0.755	0.080	0.001	0.000	0.000	0.000	0.000	0.000	0.000	0.000	0.000	38.47	-1.35	0.01	0.00	0.00	0.00	0.000	0.000	0.000	0.000	0.000	0.000	37.13	28.750
20.0	6.26	28.48	0.152	0.688	0.034	0.000	0.000	0.000	0.000	0.000	0.000	0.000	0.000	0.000	35.03	-0.56	0.00	0.00	0.00	0.00	0.000	0.000	0.000	0.000	0.000	0.000	34.45	28.125
30.0	7.01	28.48	0.228	0.570	0.006	0.000	0.000	0.000	0.000	0.000	0.000	0.000	0.000	0.000	29.05	-0.11	0.00	0.00	0.00	0.00	0.000	0.000	0.000	0.000	0.000	0.000	28.94	25.000
40.0	7.83	28.48	0.304	0.473	0.001	0.000	0.000	0.000	0.000	0.000	0.000	0.000	0.000	0.000	24.09	-0.02	0.00	0.00	0.00	0.00	0.000	0.000	0.000	0.000	0.000	0.000	24.07	21.875
50.0	8.00	28.48	0.3799	0.392	0.000	0.000	0.000	0.000	0.000	0.000	0.000	0.000	0.000	0.000	19.97	0.00	0.00	0.00	0.00	0.00	0.000	0.000	0.000	0.000	0.000	0.000	19.97	18.750
61.0	8.34	28.48	0.4635	0.319	0.000	0.000	0.000	0.000	0.000	0.000	0.000	0.000	0.000	0.000	16.25	0.00	0.00	0.00	0.00	0.00	0.000	0.000	0.000	0.000	0.000	0.000	16.25	16.250
73.0	8.82	28.48	0.5547	0.255	0.000	0.000	0.000	0.000	0.000	0.000	0.000	0.000	0.000	0.000	12.98	0.00	0.00	0.00	0.00	0.00	0.000	0.000	0.000	0.000	0.000	0.000	12.98	15.625
90.0	8.89	28.48	0.6839	0.185	0.000	0.000	0.000	0.000	0.000	0.000	0.000	0.000	0.000	0.000	9.44	0.00	0.00	0.00	0.00	0.00	0.000	0.000	0.000	0.000	0.000	0.000	9.44	12.500
103.0	8.98	28.48	0.7827	0.145	0.000	0.000	0.000	0.000	0.000	0.000	0.000	0.000	0.000	0.000	7.402	0.00	0.00	0.00	0.00	0.00	0.000	0.000	0.000	0.000	0.000	0.000	7.40	9.375
110.0	9.01	28.48	0.8359	0.127	0.000	0.000	0.000	0.000	0.000	0.000	0.000	0.000	0.000	0.000	6.492	0.00	0.00	0.00	0.00	0.00	0.000	0.000	0.000	0.000	0.000	0.000	6.49	9.375
140.0	9.16	28.48	1.0639	0.073	0.000	0.000	0.000	0.000	0.000	0.000	0.000	0.000	0.000	0.000	3.701	0.00	0.00	0.00	0.00	0.00	0.000	0.000	0.000	0.000	0.000	0.000	3.70	6.250
161.0	9.27	28.48	1.2234	0.049	0.000	0.000	0.000	0.000	0.000	0.000	0.000	0.000	0.000	0.000	2.498	0.00	0.00	0.00	0.00	0.00	0.000	0.000	0.000	0.000	0.000	0.000	2.50	3.125
187.0	9.37	28.48	1.421	0.030	0.000	0.000	0.000	0.000	0.000	0.000	0.000	0.000	0.000	0.000	1.535	0.00	0.00	0.00	0.00	0.00	0.000	0.000	0.000	0.000	0.000	0.000	1.53	3.125
220.0	9.52	28.48	1.6718	0.016	0.000	0.000	0.000	0.000	0.000	0.000	0.000	0.000	0.000	0.000	0.827	0.00	0.00	0.00	0.00	0.00	0.000	0.000	0.000	0.000	0.000	0.000	0.83	2.500
240.0	9.58	28.48	1.8237	0.011	0.000	0.000	0.000	0.000	0.000	0.000	0.000	0.000	0.000	0.000	0.569	0.00	0.00	0.00	0.00	0.00	0.000	0.000	0.000	0.000	0.000	0.000	0.57	1.250
271.0	9.68	28.48	2.0593	0.006	0.000	0.000	0.000	0.000	0.000	0.000	0.000	0.000	0.000	0.000	0.318	0.00	0.00	0.00	0.00	0.00	0.000	0.000	0.000	0.000	0.000	0.000	0.32	0.000
290.0	9.77	28.48	2.2037	0.004	0.000	0.000	0.000	0.000	0.000	0.000	0.000	0.000	0.000	0.000	0.223	0.00	0.00	0.00	0.00	0.00	0.000	0.000	0.000	0.000	0.000	0.000	0.22	0.000
300.0	9.77	28.48	2.2797	0.004	0.000	0.000	0.000	0.000	0.000	0.000	0.000	0.000	0.000	0.000	0.185	0.00	0.00	0.00	0.00	0.00	0.000	0.000	0.000	0.000	0.000	0.000	0.18	0.000
360.0	9.89	28.48	2.7356	0.001	0.000	0.000	0.000	0.000	0.000	0.000	0.000	0.000	0.000	0.000	0.060	0.00	0.00	0.00	0.00	0.00	0.000	0.000	0.000	0.000	0.000	0.000	0.06	0.000
375.0	9.916	28.48	2.8496	0.001	0.000	0.000	0.000	0.000	0.000	0.000	0.000	0.000	0.000	0.000	0.045	0.00	0.00	0.00	0.00	0.00	0.000	0.000	0.000	0.000	0.000	0.000	0.05	0.000
1020	10.71	28.48	7.7509	0.000	0.000	0.000	0.000	0.000	0.000	0.000	0.000	0.000	0.000	0.000	0.000	0.00	0.00	0.00	0.00	0.00	0.000	0.000	0.000	0.000	0.000	0.000	0.00	0.000
2910	10.94	28.48	22.113	0.000	0.000	0.000	0.000	0.000	0.000	0.000	0.000	0.000	0.000	0.000	0.000	0.00	0.00	0.00	0.00	0.00	0.000	0.000	0.000	0.000	0.000	0.000	0.00	0.000
3263	10.98	28.48	24.795	0.000	0.000	0.000	0.000	0.000	0.000	0.000	0.000	0.000	0.000	0.000	0.000	0.00	0.00	0.00	0.00	0.00	0.000	0.000	0.000	0.000	0.000	0.000	0.00	0.000
4365	11.12	28.48	33.169	0.000	0.000	0.000	0.000	0.000	0.000	0.000	0.000	0.000	0.000	0.000	0.000	0.00	0.00	0.00	0.00	0.00	0.000	0.000	0.000	0.000	0.000	0.000	0.00	0.000
11540	11.65	28.48	87.692	0.000	0.000	0.000	0.000	0.000	0.000	0.000	0.000	0.000	0.000	0.000	0.000	0.00	0.00	0.00	0.00	0.00	0.000	0.000	0.000	0.000	0.000	0.000	0.00	0.000
11850	11.66	28.48	90.048	0.000	0.000	0.000	0.000	0.000	0.000	0.000	0.000	0.000	0.000	0.000	0.000	0.00	0.00	0.00	0.00	0.00	0.000	0.000	0.000	0.000	0.000	0.000	0.00	0.000
32026	12.06	28.48	243.36	0.000	0.000	0.000	0.000	0.000	0.000	0.000	0.000	0.000	0.000	0.000	0.000	0.00	0.00	0.00	0.00	0.00	0.000	0.000	0.000	0.000	0.000	0.000	0.00	0.000

Table 10

